



Catalog No. 2009

# MICHIGAN PNEUMATIC TOOL

## Industrial Air Tools



**Get it Fast  
Get it First**



**NPK Exclusively from MPT**



### **Serving All Industries**

- Aircraft
- Assembly
- Automotive
- Petro Chemical
- Rental
- Foundry
- Construction

**1-800-521-8104 • [www.michiganpneumatic.com](http://www.michiganpneumatic.com)**

# The MICHIGAN PNEUMATIC TOOL Experts Deliver The Solutions To Your Air Tool Needs

Need to know where to turn for the right tools for your job? Our dedicated team has the experience and know-how to give you the quality products and service you require. Take advantage of our knowledge today for the solutions to your air tool needs.

**Michigan Pneumatic** air tools are designed to be safe, dependable and affordable. Our products are highly engineered to meet our rigid quality standards. Every tool in the **MPT** line is tested for performance, strength, durability and precision accuracy to ensure unsurpassed quality. This quality, plus great savings, is reflected in the increasing number of **MPT** tools found in every industry around the world.

**MPT** tools are completely guaranteed. When a tool shows signs of wear and parts need to be replaced, we are ready to provide any part you need from our large inventory. You are assured fast, reliable service from company you know and trust.



**Gary Wine**  
President



**Robert Arthur**  
Vice President



**Howard Davidson**  
General Manager



#### **OPERATIONS**

Matthew Holiday, Tracy Monthei  
Bridget Butler, Michelle Dankanics



#### **CUSTOMER SERVICE**

Theresa Charles, Julie Sprau  
Dawn Mathews



#### **ACCOUNTING**

Karen Polaski, Nancy Self  
Bev Lakomy, Gayle Vernatt

# MICHIGAN PNEUMATIC TOOL, INC.

**America's Largest, Most Dependable Air Tool Dealer,  
Featuring Top Quality, Guaranteed Air Tools And Equipment  
For Immediate Delivery At Competitive Prices**



## The MPT Promise

**Michigan Pneumatic** is committed to providing top quality products designed to stand up under the most rigorous applications, as well as providing fully personalized service for every sale by our qualified staff. We promise to every **MPT** distributor and end user to maintain our standard of high dependability at competitive and reasonable prices. We insist upon quality, and backup every product with our **MPT** warranty. That's a promise we strive to keep.

## Full Line Inventory

**Michigan Pneumatic** maintains millions of dollars of inventory, in a wide selection of tools and equipment for a wide range of business and industries. Our product line includes all kinds of hoisting and material handling equipment; a complete line of air tools and accessories for every job, from sanders, hammers, impacts and grinders to powerful tuggers. Our service oriented company and well-stocked warehouse assure fast, dependable delivery.

## Parts Department

We at **MPT** take pride in the size and efficiency of our parts department. Our goal is to keep a continuous stock of replacement parts for immediate delivery. From the smallest washer to any large housing, you can rely on our parts department for speedy, efficient service. We carry a comprehensive parts inventory for all air tools sold by **Michigan Pneumatic Tool**, as well as ensuring all parts are available for quick delivery. Rest assured that when replacement parts are needed, our qualified staff can select from one of the largest parts departments in the nation.

## Unique Trade-In Offer

**Michigan Pneumatic** offers a generous trade-in allowance on used air tools. This allowance will be applied toward the purchase of any new **MPT** tool. We will gladly assign a value upon receipt of your surplus or unneeded tools. We are sure you will be pleased with our favorable quotations. Send in your old tools and save.

## Repair Department

Our repair department is staffed by competent technicians who know air tools. Our experienced technicians are trained to rebuild any make of air tool, the factory way. Every tool is completely torn down and examined for wear and tear. Worn parts are replaced to reduce maintenance costs and unnecessary tool replacement. We will furnish an estimate when the cost to repair exceeds 50% of the price of the tool, or when requested. Every repair is completely guaranteed. Send your tools in today.

## Pricing Policy

Dependability and fair pricing are features of **Michigan Pneumatic**. We offer savings of up to 50% in comparison with other manufacturers selling quality industrial tools. How do we do it? We work on a small markup and fast turnover. The customer benefits on the price. You buy with complete confidence because every tool is completely guaranteed.



### TECHNICAL

Dave Dolinski, Jeff Dever  
Eric Moon, Derrick Trottier



### SALES

Joe Ruder, Robert Ferrari, Rick Stillings  
Alan Kurth, Jason Mumau, Ken Thompson



### SHIPPING

Nick Ploch, Sam Collier, Eric Socia  
Tommy Gordon, Tracy Monthei



# MICHIGAN PNEUMATIC® TOOL, INC.

Dear Customer,

We here at Michigan Pneumatic Tool proudly present our newest, most comprehensive catalog ever. This edition has been carefully compiled to inform you of our wide selection of quality products at reasonable and competitive prices. In addition to our quality tools and equipment that you've come to know and trust, we are pleased to introduce the latest new air tool models on the market.

Michigan Pneumatic Tool has always been a service-oriented company, stocking a tremendous variety of tools and equipment for immediate delivery. Most orders are shipped from stock the same day they are received, and as always, our repair department provides you with expert service and replacement parts for all brands of air tools.

All of our products are covered by our unconditional money back guarantee. We take special pride in our selection of tools and the service provided by Michigan Pneumatic Tool, where sixty-six years of experience accompanies every tool.

Our staff promises to provide you with fast and efficient service for all of your air tool requirements.

Yours truly,

Gary Wine

President

Michigan Pneumatic Tool, Inc.

## Michigan Pneumatic Stretches Air Tool Buying Power

As a leader in the industry, Michigan Pneumatic was the first to import quality air tools over forty years ago. Today, combined expertise in this field and tremendous buying power assures you, the customer, of getting more for your money with Michigan Pneumatic.

Significant savings are only part of the Michigan Pneumatic objective. We save you time by offering the ability to compare the advantages of various tools at your convenience. Buy with complete confidence knowing every product is quality tested and completely guaranteed. Michigan Pneumatic insists on quality, and every product is backed up with the Michigan Pneumatic warranty.

## LIMITED EXPRESS WARRANTY

Michigan Pneumatic Tool, Inc. makes every effort to ensure that its products are of high quality, and warrants all new products it sells to be free from defects in materials and workmanship for a period of one hundred eighty (180) days from the date of original purchase. All rebuilt products carry a thirty (30) day warranty.

This warranty shall not apply to defects due, directly or indirectly, to abuse, misuse, negligence, normal wear and tear or improper maintenance, nor shall it apply to any product which has been repaired or altered outside of our facilities.

Should any product fail to provide satisfactory service, return the complete product requiring warranty service to Michigan Pneumatic Tool for examination, with transportation charges prepaid, together with an explanation of the complaint and proof of purchase. Michigan Pneumatic Tool guarantees to repair or replace any product found upon our inspection to be so defective.

Michigan Pneumatic Tool makes no other warranty expressed or implied and expressly disclaims any implied warranty of merchantability or fitness for a particular purpose. There are no warranties which extend beyond the description contained herein.

Michigan Pneumatic Tool shall in no event be liable for death, injuries to persons or property, or for incidental, consequential, indirect or special damages of any nature arising from the sale or use of the products, excepting only the cost or expense of repair and replacement as described above.

This warranty gives the customer specific legal rights. Other legal rights may vary from state to state.

- Delivery** ..... We ship U.P.S., Parcel Post, Air and Freight to all parts of the world. Any shipments over 150 lbs. will be shipped via truck, freight collect.
- Terms** ..... Net 30 days, FOB Detroit. 1-1/2% service charge per month (18% per annum) will be added on past due invoices. For immediate delivery, if credit has not yet been established, we will gladly ship C.O.D., freight collect, or accept MC/VISA (Some restrictions may apply). When sending a check with your order, add a minimum shipping and handling charge of \$8.50. We will bill you for any difference in freight charges.
- Handling Fee** ..... \$4.25 per package (UPS), \$5.00 per pallet LTL
- Minimum Billing** ..... \$25.00 Net. (\$50.00 if using Credit Card)
- Returns** ..... There is a 20% restocking charge on all returns. Before returning items, you must obtain a Return Authorization Number. This must be done within five (5) days of receipt of items. Ship returns, freight prepaid, in the original cartons. Upon receipt of the returned items, in unused and acceptable condition, we will issue a credit to your account.
- Damages/Shortages** ..... On arrival, the consignments should be carefully and thoroughly inspected for any sign of damage or shortage.

Any damage or shortage should be noted on the freight bill before signing the receipt. If the item cannot be inspected properly, we recommend you sign the freight bill marked "Subject To Inspection". It is your responsibility to report immediately to the carrier any package or crate received in a damaged condition, and to request an inspection report. If you notice any damage after unpacking the shipment, notify the transport company immediately and request an inspection. Damage claims must be made with the carrier.

**NOTE:** All packaging material must be retained until the shipment is inspected by the carrier and your claim is settled.

**Prices** ..... Prices of any product are subject to change or withdrawal without notice.

**New Accounts** ..... To open a new account requires a good Dun & Bradstreet rating. New customers should submit a completed credit application. Please allow up to three weeks for processing.



When using a credit card, please have your card number, expiration date, V-code and cardholder's name ready.



Impact Wrenches . . . . .	4
Pulsus Tools . . . . .	17
Sockets & Screwdriver Accessories . . . . .	22
Screwdrivers . . . . .	26
Drills . . . . .	30
Sanders . . . . .	44
Die Grinders & Routers . . . . .	53
Wheel Grinders . . . . .	62
Air Nippers & Saws . . . . .	74
Shears & Nibblers . . . . .	80
Riveters . . . . .	86
Air Hammers . . . . .	99
Aircraft Riveters . . . . .	100
Planishing Hammer Accessories . . . . .	104
Rivet Busters . . . . .	105
Chipping Hammers . . . . .	109
Scalers . . . . .	115
Rammers . . . . .	124
Clay Diggers & Pavement Breakers . . . . .	129
Concrete Vibrators . . . . .	135
Rock Drills . . . . .	136
Hoists & Tuggers . . . . .	138
Trolleys . . . . .	144
Tool Balancers & Hose Reels . . . . .	148
Clamps & Vises . . . . .	150
Air Line Accessories . . . . .	152
Filters, Regulators & Lubricators . . . . .	153
Air Manifolds . . . . .	156
Hoses & Couplers . . . . .	157
Air Movers . . . . .	161
<b>Index . . . . .</b>	<b>162</b>



Call Toll Free: **1-800-521-8104**

Phone: (313) 933-5890 • Fax: (313) 933-0440

[www.michiganpneumatic.com](http://www.michiganpneumatic.com) • e-mail: [mpt@michiganpneumatic.com](mailto:mpt@michiganpneumatic.com)

**America's Largest Manufacturer of Air Tools and Replacement Parts**  
**Serving All Industries: Aircraft, Assembly, Automotive, Construction, Foundry and Petro Chemical**

PRICES SUBJECT TO CHANGE WITHOUT NOTICE. THIS CATALOG SUPERSEDES ALL PREVIOUS CATALOGS.  
Copyright ©2008 Michigan Pneumatic® Tool, Inc.

No material in this catalog may be reprinted in any form without written permission from Michigan Pneumatic Tool, Inc.

# Reversible Auto-Impacts & Ratchets



MP-2760C-ST



MP-728-ST



MP-1625-ST

Features a ball-type anvil. Versatility that combines speed with power. Uses include small engine repairs, water pumps, radiators and air conditioning units. Ideal for use in limited work areas. **SH-0719RA 1/4" ratchet head assembly available for Model MP-2760C-ST. SH-30RA 3/8" ratchet head assembly available for MP-728-ST. SH-735RA 1/2" ratchet head assembly available for Model MP-1625-ST.**

Model No.	Square Drive	Free Speed	Ultimate Torque	Length	Weight	Rec'd Hose Size	Air Inlet Thread	Avg. Air Consumption
MP-2760C-ST	1/4"	240 rpm	18 ft.-lbs.	6-1/4"	1.0 lb.	1/4"	1/4"	3.0 cfm
MP-728-ST	3/8"	150 rpm	50 ft.-lbs.	10"	2.5 lbs.	3/8"	1/4"	4.0 cfm
MP-1625-ST	1/2"	150 rpm	90 ft.-lbs.	15"	4.5 lbs.	3/8"	1/4"	5.0 cfm



## Michigan Pneumatic Model MP-2402P-DD

### Power Ratchet - 1/2" Square Drive



Features a ball-type anvil. A true 1/2" ratchet for heavy duty applications. The length of the tool allows for increased leverage on high torque bolts. Ideal for use in limited work areas.

Square Drive .....	1/2"	Length .....	10-11/16"
Free Speed .....	160 rpm	Weight .....	3.0 lbs.
Ultimate Torque .....	95 ft.-lbs.	Air Inlet Thread .....	1/4"
Rec'd Hose Size .....	3/8"	Avg. Air Consumption .....	5.0 cfm



## Michigan Pneumatic Model MP-720-ST

### Straight Impact - 3/8" Square Drive



Features a friction ring anvil. This compact impact is easily maneuverable for hard to reach places, rugged and lightweight. The aluminum housing is protected by rubber guards. Equipped with swivel air inlet and built-in regulator. Butterfly trigger for better speed control.

Square Drive .....	3/8"	Length .....	5-1/2"
Free Speed .....	10000 rpm	Weight .....	2.25 lbs.
Ultimate Torque .....	75 ft.-lbs.	Air Inlet Thread .....	1/4"
Rec'd Hose Size .....	3/8"	Avg. Air Consumption .....	3.0 cfm

## Ingersoll-Rand Model IR-5000A

### Pistol Impact - 1/4" Square Drive



Features a pin-type anvil. Designed for the removal of small nuts and bolts, assembly line work or for use in restricted quarters. **Model MP-5000A-IR with screwdriver attachment available.**

Square Drive .....	1/4"	Length .....	7-7/8"
Free Speed .....	1400 rpm	Weight .....	2.125 lbs.
Ultimate Torque .....	20-40 in.-lbs.	Air Inlet Thread .....	1/4"
Rec'd Hose Size .....	3/8"	Avg. Air Consumption .....	6.0 cfm



MP-5000A-IR



## Michigan Pneumatic Model MP-7125

### Angle Impact - 3/8" Square Drive

Features a friction ring anvil. This popular "Angle" 3/8" drive wrench features a rocking dog impact mechanism, built-in power regulator and an instant forward and reverse throttle for speed control. New streamlined design with motor behind clutch mechanism for easy handling.

Square Drive .....	3/8"	Length .....	4-1/2"
Free Speed .....	8000 rpm	Weight .....	2.5 lbs.
Ultimate Torque .....	80 ft.-lbs.	Air Inlet Thread .....	1/4"
Rec'd Hose Size .....	3/8"	Avg. Air Consumption .....	2.5 cfm



## Michigan Pneumatic Model MP-135-ST

### Angle Impact - 3/8" Square Drive

Features a friction ring anvil. Features a built-in regulator for positive speed and torque control and single-handed thru bolt action reverse operation. A ring socket retainer allows for rapid socket changes.

Square Drive .....	3/8"	Length .....	5"
Free Speed .....	10000 rpm	Weight .....	2.625 lbs.
Ultimate Torque .....	75 ft.-lbs.	Air Inlet Thread .....	1/4"
Rec'd Hose Size .....	3/8"	Avg. Air Consumption .....	3.0 cfm



## Nippon Pneumatic Model SW-12

### Angle Impact - 3/8" Square Drive

Features a friction ring anvil. Used mostly in repair shops and garages. Features include lightweight, low air consumption and exceptionally powerful impacting per blow. Also features a built-in power regulator for easy adjustment.

Square Drive .....	3/8"	Length .....	4-7/8"
Free Speed .....	8000 rpm	Weight .....	2.8 lbs.
Ultimate Torque .....	165 ft.-lbs.	Air Inlet Thread .....	1/4"
Rec'd Hose Size .....	1/4"	Avg. Air Consumption .....	3.5 cfm



## Michigan Pneumatic Model MP-SWH-13

### Angle Impact - 1/2" Square Drive

Features a pin-type anvil. Close quarter industrial angle wrench is fully reversible and perfectly balanced for easy maneuverability. Built-in power regulator matches speed and power to each job. **Uses brass end plates for longer wear.**

Square Drive .....	1/2"	Length .....	7-7/8"
Free Speed .....	5800 rpm	Weight .....	5.3 lbs.
Ultimate Torque .....	225 ft.-lbs.	Air Inlet Thread .....	1/4"
Rec'd Hose Size .....	3/8"	Avg. Air Consumption .....	4.0 cfm



## Michigan Pneumatic Model MP-121T-ST

### Pistol Impact - 1/2" Square Drive

Features a friction ring anvil. Medium duty air wrench has a durable, one-piece balanced housing for comfortable use. Equipped with a single hammer rocking dog clutch mechanism. Has a built-in power regulator for adjustable torque output. Ideal for automobile repair work.

Square Drive .....	1/2"	Length .....	6-1/4"
Free Speed .....	7000 rpm	Weight .....	5.25 lbs.
Ultimate Torque .....	250 ft.-lbs.	Air Inlet Thread .....	1/4"
Rec'd Hose Size .....	3/8"	Avg. Air Consumption .....	4.0 cfm

# General Line Impact Wrenches



## Michigan Pneumatic Model MP-1700

### Pistol Impact - 1/2" Square Drive

Features a friction ring anvil. Twin Hammer clutch mechanism provides good durability and performance. Excellent weight and balance to reduce operator fatigue. High output motor provides high torque levels for removing nuts. Model MP-1700P2 with a 2" extended anvil available. Model MP-1700PA with pin-type anvil available.

Square Drive .....	1/2"	Length .....	7"
Free Speed .....	6500 rpm	Weight .....	5.3 lbs.
Torque Range .....	37-370 ft.-lbs.	Air Inlet Thread .....	1/4"
Rec'd Hose Size .....	1/4"	Avg. Air Consumption .....	23.8 cfm



## Michigan Pneumatic Model MP-3344

### Pistol Impact - 1/2" Square Drive

Features a pin-type anvil. Designed for heavy production assembly. Short length for close quarter nutrunning. Uses brass end plates for longer wear. Model MP-3344P2 with a 2" extended anvil available. Industrial model.

Square Drive .....	1/2"	Length .....	7-1/4"
Free Speed .....	7000 rpm	Weight .....	6.6 lbs.
Torque Range .....	100-331 ft.-lbs.	Air Inlet Thread .....	1/4"
Rec'd Hose Size .....	3/8"	Avg. Air Consumption .....	5.3 cfm



## Michigan Pneumatic Model MP-2006-ST

### Pistol Impact - 3/4" Square Drive

Features a friction ring anvil. Twin hammer design built for power and durability. Well-balanced, comfortable grip handle and low noise combine to reduce operator fatigue. Features a three position power regulator built-in.

Square Drive .....	3/4"	Length .....	8-1/2"
Free Speed .....	5500 rpm	Weight .....	11.2 lbs.
Torque Range .....	150-950 ft.-lbs.	Air Inlet Thread .....	3/8"
Rec'd Hose Size .....	1/2"	Avg. Air Consumption .....	60 cfm



## Michigan Pneumatic Model MP-1100-A2

### Pistol Impact - 3/4" Square Drive

Features a friction ring anvil. Compact, lightweight wrench has an adjustable power regulator for stabilized torque. 2" extended anvil is standard. Good for medium-duty tire repair and heavy-duty automotive repair.

Square Drive .....	3/4"	Length .....	12"
Free Speed .....	5000 rpm	Weight .....	9.4 lbs.
Torque Range .....	125-525 ft.-lbs.	Air Inlet Thread .....	1/4"
Rec'd Hose Size .....	3/8"	Avg. Air Consumption .....	7.0 cfm



## Chicago Pneumatic Model CP-797-6

### Impact Wrench - 1" Square Drive

Features a friction ring anvil. The 1" workhorse for dependable, reliable service. A truck and trailer tire industry icon.

Square Drive .....	1"	Length .....	22-1/4"
Free Speed .....	5100 rpm	Weight .....	29.75 lbs.
Working Torque .....	150-900 ft.-lbs.	Air Inlet Thread .....	1/2"
Rec'd Hose Size .....	1/2"	Avg. Air Consumption .....	12.0 cfm



# General Line Impact Wrenches



## Michigan Pneumatic Model MP-1241P-ST

### Pistol Impact - 3/8" Square Drive

Features a friction ring anvil. Lightweight, composite motor housing for use in repair shops and garages. Features twin hammer mechanism for power. One hand push button forward-reverse and built-in power regulator.

Square Drive .....	3/8"	Length .....	6"
Free Speed .....	10000 rpm	Weight .....	2.6 lbs.
Working Torque .....	25-200 ft.-lbs.	Air Inlet Thread .....	1/4"
Rec'd Hose Size .....	3/8"	Avg. Air Consumption .....	4.0 cfm



## Michigan Pneumatic Model MP-1243P-ST

### Pistol Impact - 1/2" Square Drive

Features a friction ring anvil. Twin hammer mechanism for power and durability. Features one hand push button forward-reverse and built-in power regulator.

Square Drive .....	1/2"	Length .....	6"
Free Speed .....	11000 rpm	Weight .....	2.6 lbs.
Working Torque .....	25-250 ft.-lbs.	Air Inlet Thread .....	1/4"
Rec'd Hose Size .....	3/8"	Avg. Air Consumption .....	4.0 cfm



## Michigan Pneumatic Model MP-3143P1-ST

### Pistol Impact - 1/2" Square Drive

Features a friction ring anvil. Ergonomic handle features a thumb operated three position forward and full power reverse lever. Twin hammer mechanism for power.

Square Drive .....	1/2"	Length .....	8"
Free Speed .....	6000 rpm	Weight .....	4.85 lbs.
Working Torque .....	50-460 ft.-lbs.	Air Inlet Thread .....	1/4"
Rec'd Hose Size .....	1/2"	Avg. Air Consumption .....	4.4 cfm



## Ingersoll-Rand Model IR-2112

### Pistol Impact - 3/8" Square Drive

Features a friction ring anvil. A new addition to the IR line. Ergonomic, lightweight and very high torque.

Square Drive .....	3/8"	Length .....	6"
Free Speed .....	10000 rpm	Weight .....	2.89 lbs.
Working Torque .....	20-150 ft.-lbs.	Air Inlet Thread .....	1/4"
Rec'd Hose Size .....	3/8"	Avg. Air Consumption .....	2.5 cfm



## Ingersoll-Rand Model IR-2131A

### Pistol Impact - 1/2" Square Drive

Features a friction ring anvil. Lightweight, ergonomic impact with push button control features extremely high torque in forward and reverse.

Square Drive .....	1/2"	Length .....	7"
Free Speed .....	9500 rpm	Weight .....	4.5 lbs.
Working Torque .....	50-400 ft.-lbs.	Air Inlet Thread .....	1/4"
Rec'd Hose Size .....	3/8"	Avg. Air Consumption .....	4.8 cfm



## Ingersoll-Rand Model IR-212

### **Pistol Impact** - 3/8" Square Drive

Features a friction ring anvil. Lightweight, high-torque impact wrench, perfect for repair shops and garages — a mechanic's true best friend.

Square Drive .....	3/8"	Length .....	6"
Free Speed .....	10000 rpm	Weight .....	2.89 lbs.
Working Torque .....	20-150 ft.-lbs.	Air Inlet Thread .....	1/4"
Rec'd Hose Size .....	3/8"	Avg. Air Consumption .....	2.5 cfm



## Ingersoll-Rand Model IR-231C

### **Pistol Impact** - 1/2" Square Drive

Features a friction ring anvil. Double hammer impact mechanism offers long, dependable service.

Square Drive .....	1/2"	Length .....	7-1/4"
Free Speed .....	8000 rpm	Weight .....	5.8 lbs.
Working Torque .....	25-300 ft.-lbs.	Air Inlet Thread .....	1/4"
Rec'd Hose Size .....	3/8"	Avg. Air Consumption .....	4.2 cfm



## Chicago Pneumatic Model CP-734H

### **Pistol Impact** - 1/2" Square Drive

Features a friction ring anvil. Dependable, serviceable tool with high torque.

Square Drive .....	1/2"	Length .....	7-3/8"
Free Speed .....	9000 rpm	Weight .....	5 lbs.
Working Torque .....	25-310 ft.-lbs.	Air Inlet Thread .....	1/4"
Rec'd Hose Size .....	3/8"	Avg. Air Consumption .....	3.5 cfm



## Chicago Pneumatic Model CP-772H

### **Pistol Impact** - 3/4" Square Drive

Features a friction ring anvil. Heavy-duty impact for fast and reliable impacting on heavy mechanical work.

Square Drive .....	3/4"	Length .....	9-5/8"
Free Speed .....	5750 rpm	Weight .....	10.5 lbs.
Working Torque .....	100-500 ft.-lbs.	Air Inlet Thread .....	1/4"
Rec'd Hose Size .....	3/8"	Avg. Air Consumption .....	7.5 cfm



## Ingersoll-Rand Model IR-261

### **Pistol Impact** - 3/4" Square Drive

Features a friction ring anvil. For big jobs that require a compact and powerful 3/4" impact to do the work that 1" tools stumble over. **Model IR-295A 1" pistol impact available.**

Square Drive .....	3/4"	Length .....	8-3/4"
Free Speed .....	5500 rpm	Weight .....	12.4 lbs.
Working Torque .....	200-900 ft.-lbs.	Air Inlet Thread .....	3/8"
Rec'd Hose Size .....	1/2"	Avg. Air Consumption .....	9.5 cfm



**NPK®**



**Nippon Pneumatic Model NW-800S**

**Straight Impact** - 3/8" Square Drive

Features a **pin-type anvil**. Used mostly in repair shops, garages and assembly applications. Features include lightweight, low air consumption and exceptional power. **Industrial model**.

Square Drive .....	3/8"	Length .....	7"
Free Speed .....	8000 rpm	Weight .....	2.4 lbs.
Torque Range .....	16-48 ft.-lbs.	Air Inlet Thread .....	1/4"
Rec'd Hose Size .....	1/4"	Avg. Air Consumption .....	3.5 cfm

**NPK®**



**Nippon Pneumatic Model NAW-1200SPTS**

**Straight Impact** - 1/2" Square Drive

Features a **pin-type anvil**. Single hammer impact wrench is used in repair and garage work shops. Features a built-in power regulator to provide four steps of power control. This wrench is distinguished by its light weight, low air consumption and powerful impacting per blow. **Uses brass end plates for longer wear. Industrial model**.

Square Drive .....	1/2"	Length .....	11"
Free Speed .....	7000 rpm	Weight .....	4.3 lbs.
Torque Range .....	80-170 ft.-lbs.	Air Inlet Thread .....	1/4"
Rec'd Hose Size .....	3/8"	Avg. Air Consumption .....	3.5 cfm

**NPK®**



**Nippon Pneumatic Model NW-1200BPTS**

**Pistol Impact** - 1/2" Square Drive

Features a **pin-type anvil**. This compact, single hammer impact wrench is easily maneuverable for hard to reach places, rugged and lightweight. Features built-in 4-step power regulator standard. Frequently used in repair shops, garages and assembly applications.

Square Drive .....	1/2"	Length .....	6-7/8"
Free Speed .....	7000 rpm	Weight .....	4.0 lbs.
Torque Range .....	55-118 ft.-lbs.	Air Inlet Thread .....	1/4"
Rec'd Hose Size .....	1/4"	Avg. Air Consumption .....	3.5 cfm

**NPK®**



**Nippon Pneumatic Model NW-1600HARTR**

**Pistol Impact** - 1/2" Square Drive

Features a **combination friction ring and through-hole anvil**. Lightweight single hammer impact wrench ideal for automotive repair and assembly applications. Features an ergonomic grip, quick reverse lever and built-in 4-step power regulator standard.

Square Drive .....	1/2"	Length .....	7-11/16"
Free Speed .....	5000 rpm	Weight .....	5.5 lbs.
Torque Range .....	74-184 ft.-lbs.	Air Inlet Thread .....	1/4"
Rec'd Hose Size .....	1/4"	Avg. Air Consumption .....	5.3 cfm

**NPK®**



**Nippon Pneumatic Model NW-2000HAPTS**

**Pistol Impact** - 3/4" Square Drive

Features a **pin-type anvil**. Heavy-duty single hammer impact wrench ideal for assembly and industrial applications. Features an ergonomic grip, quick reverse lever and built-in 4-step power regulator standard. Dependable, serviceable tool with high torque.

Square Drive .....	3/4"	Length .....	9-1/16"
Free Speed .....	4500 rpm	Weight .....	8.4 lbs.
Torque Range .....	170-405 ft.-lbs.	Air Inlet Thread .....	1/4"
Rec'd Hose Size .....	3/8"	Avg. Air Consumption .....	7.1 cfm

# General Line & Industrial Impact Wrenches



## Michigan Pneumatic Model MP-181SX-A6

### Impact Wrench - 1" Square Drive

Features a combination friction ring and through-hole anvil. Heavy-duty 6" extended shank impact is ideal for use on wheels with recessed rims. Double blow impact mechanism provides high torque output.

Square Drive .....	1"	Length .....	21"
Free Speed .....	4000 rpm	Weight .....	27 lbs.
Torque Range .....	280-1000 ft.-lbs.	Air Inlet Thread .....	1/2"
Rec'd Hose Size .....	1/2"	Avg. Air Consumption .....	12.0 cfm



## Michigan Pneumatic Model MP-612

### Pistol Impact - 1" Square Drive

Features a friction ring anvil. Lightweight, compact, heavy-duty impact is recommended for heavy assembly work. Used in fleet, spring and farm equipment shops. Also good for servicing wheel nuts on big trucks.

Square Drive .....	1"	Length .....	10-1/4"
Free Speed .....	4000 rpm	Weight .....	19.5 lbs.
Torque Range .....	280-1000 ft.-lbs.	Air Inlet Thread .....	1/2"
Rec'd Hose Size .....	1/2"	Avg. Air Consumption .....	10.0 cfm



## Michigan Pneumatic Model MP-3200P

### Pistol Impact - 1" Square Drive

Features a through-hole anvil. Industrial Model. Short length and perfectly centered dead handle allow easy handling in cramped spaces. Built-in power regulator is standard. Model MP-3200P6 with a 6" extended anvil available. Uses brass end plates for longer wear.

Square Drive .....	1"	Length .....	11-3/8"
Free Speed .....	4000 rpm	Weight .....	26.2 lbs.
Torque Range .....	290-1008 ft.-lbs.	Air Inlet Thread .....	3/8"
Rec'd Hose Size .....	1/2"	Avg. Air Consumption .....	10.6 cfm



## Nippon Pneumatic Model NW-3500P

### Pistol Impact - 1" Square Drive

Features a through-hole anvil. Industrial Model. Heavy-duty single hammer design used mainly in garages and repair shops. Built-in power regulator and thumb operated forward-reverse lever.

Square Drive .....	1"	Length .....	11"
Free Speed .....	4000 rpm	Weight .....	20.2 lbs.
Torque Range .....	472-1032 ft.-lbs.	Air Inlet Thread .....	3/8"
Rec'd Hose Size .....	1/2"	Avg. Air Consumption .....	10.6 cfm



## Nippon Pneumatic Model NWH-320P

### Pistol Impact - 1" Square Drive

Features a through-hole anvil. Industrial Model. Efficient, heavy-duty clutch impact allows fast rundown and high torque output. Very effective in shipyards, bridge building, construction sites and heavy manufacturing plants.

Square Drive .....	1"	Length .....	10-13/16"
Free Speed .....	4000 rpm	Weight .....	21.6 lbs.
Torque Range .....	280-1327 ft.-lbs.	Air Inlet Thread .....	3/8"
Rec'd Hose Size .....	1/2"	Avg. Air Consumption .....	17.7 cfm

# Industrial Impact Wrenches



**NPK®**



## Nippon Pneumatic Model NW-22AA

### Impact Wrench - 3/4" Square Drive

Features a through-hole anvil. Twin hammer mechanism for power and durability. Designed for assembly line work. Features a low vibration handle and four step power regulator.

Square Drive .....	3/4"	Length .....	15-11/16"
Free Speed .....	4500 rpm	Weight .....	17.6 lbs.
Torque Range .....	398-627 ft.-lbs.	Air Inlet Thread .....	3/8"
Rec'd Hose Size .....	1/2"	Avg. Air Consumption .....	21.2 cfm

**NPK®**



## Nippon Pneumatic Model NWH-320AU

### Impact Wrench - 1" Square Drive

Features a through-hole anvil. Ideal for extra heavy-duty jobs, eliminating the use of hand wrenches. Efficient, heavy duty clutch allows fast rundown and high torque output. Uses brass end plates for longer wear. Model NWH-320A with outside trigger available.

Square Drive .....	1"	Length .....	14-1/2"
Free Speed .....	4000 rpm	Weight .....	20 lbs.
Torque Range .....	1003-1327 ft.-lbs.	Air Inlet Thread .....	3/8"
Rec'd Hose Size .....	1/2"	Avg. Air Consumption .....	17.7 cfm

**NPK®**



## Nippon Pneumatic Model NW-32LA

### Impact Wrench - 1" Square Drive

Features a through-hole anvil. Straight type impact is ideal for extra heavy-duty jobs. Has terrific power for its weight. Will remove wheel nuts from big trucks and buses with ease. Uses brass end plates for longer wear.

Square Drive .....	1"	Length .....	15-1/16"
Free Speed .....	4000 rpm	Weight .....	23.5 lbs.
Torque Range .....	487-1032 ft.-lbs.	Air Inlet Thread .....	1/2"
Rec'd Hose Size .....	1/2"	Avg. Air Consumption .....	30.0 cfm

**NPK®**



## Nippon Pneumatic Model NW-4300GAU

### Impact Wrench - 1" Square Drive

Features a through-hole anvil. Powerful single hammer mechanism for heavy-duty jobs. Features a four step power regulator built-in. Durable construction for longer life. Model NW-4300GA with outside trigger available.

Square Drive .....	1"	Length .....	17-13/16"
Free Speed .....	4000 rpm	Weight .....	28.4 lbs.
Torque Range .....	664-1327 ft.-lbs.	Air Inlet Thread .....	1/2"
Rec'd Hose Size .....	1/2"	Avg. Air Consumption .....	14.1 cfm

**NPK®**



## Nippon Pneumatic Model NW-5000A

### Impact Wrench - 1" Square Drive

Features a through-hole anvil. Single hammer impact offers the ultimate power for those tough jobs. Heavy-duty construction for dependability. Features a built-in four step power regulator.

Square Drive .....	1"	Length .....	16-15/16"
Free Speed .....	3000 rpm	Weight .....	36.3 lbs.
Torque Range .....	840-1696 ft.-lbs.	Air Inlet Thread .....	1/2"
Rec'd Hose Size .....	1/2"	Avg. Air Consumption .....	15.9 cfm



## Michigan Pneumatic Model MP-3600M

### Impact Wrench - 3/4" Square Drive

Features a through-hole anvil. Features a two-hammer impact mechanism for greater power output. Steel clutch housing and brass end plates ensure a long, trouble free life. Built-in power regulator provides power control. **Uses brass end plates for longer wear.**

Square Drive .....	3/4"	Length .....	15-1/4"
Free Speed .....	4000 rpm	Weight .....	17.6 lbs.
Working Torque .....	604 ft.-lbs.	Air Inlet Thread .....	3/8"
Rec'd Hose Size .....	1/2"	Avg. Air Consumption .....	9.4 cfm

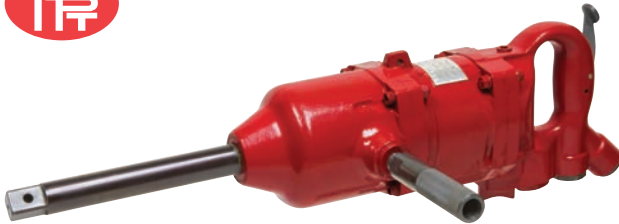

## Michigan Pneumatic Model MP-3600M6

### Impact Wrench - 3/4" Square Drive

Features a through-hole anvil. Reversible impact wrench is lightweight and easy to handle. 6" extended anvil is standard. Designed for studs in recessed quarters. Tremendous tightening and loosening power. **Uses brass end plates for longer wear.**

Square Drive .....	3/4"	Length .....	20"
Free Speed .....	4000 rpm	Weight .....	18 lbs.
Working Torque .....	575 ft.-lbs.	Air Inlet Thread .....	3/8"
Rec'd Hose Size .....	1/2"	Avg. Air Consumption .....	9.4 cfm



## Michigan Pneumatic Model MP-3200G

### Impact Wrench - 1" Square Drive

Features a through-hole anvil. Straight type impact is ideal for extra heavy-duty jobs. Has terrific power for its weight. Will remove wheel nuts from big trucks and buses with ease. **Model MP-3200G6 with a 6" extended anvil available. Uses brass end plates for longer wear.**

Square Drive .....	1"	Length .....	16"
Free Speed .....	4000 rpm	Weight .....	26.5 lbs.
Working Torque .....	900 ft.-lbs.	Air Inlet Thread .....	3/8"
Rec'd Hose Size .....	1/2"	Avg. Air Consumption .....	10.6 cfm



## Michigan Pneumatic Model MP-3650M

### Impact Wrench - 1" Square Drive

Features a through-hole anvil. Light, compact impact is recommended for heavy assembly work, managing wheel nuts on big trucks and buses. Will faithfully serve shipbuilders and bridge builders. **Uses brass end plates for longer wear.**

Square Drive .....	1"	Length .....	18"
Free Speed .....	3500 rpm	Weight .....	29 lbs.
Working Torque .....	1008 ft.-lbs.	Air Inlet Thread .....	1/2"
Rec'd Hose Size .....	1/2"	Avg. Air Consumption .....	14.1 cfm



## Michigan Pneumatic Model MP-3650M6

### Impact Wrench - 1" Square Drive

Features a through-hole anvil. Designed to drive studs in recessed spaces. Has a high power-to-weight ratio and durable construction for long working life. 6" extended anvil is standard. **Model MP-3650M6-5SPLN with a spline drive available. Uses brass end plates for longer wear.**

Square Drive .....	1"	Length .....	23"
Free Speed .....	3500 rpm	Weight .....	30 lbs.
Working Torque .....	925 ft.-lbs.	Air Inlet Thread .....	1/2"
Rec'd Hose Size .....	1/2"	Avg. Air Consumption .....	14.1 cfm



## Michigan Pneumatic Model MP-6100

### Impact Wrench - 1" Square Drive

Features a through-hole anvil. Ideal for extra heavy-duty jobs, eliminating hand wrenches. Light, compact wrench for heavy assembly work. Efficient, heavy duty clutch allows fast rundown and high torque output. **Model MP-6100-5SPLN with spline drive or MP-6100G6 with 6" extended anvil available. Uses brass end plates for longer wear. Parts are interchangeable with CP-610 impact.**

Square Drive .....	1"	Length .....	14-1/2"
Free Speed .....	4000 rpm	Weight .....	20 lbs.
Working Torque .....	1440 ft.-lbs.	Air Inlet Thread .....	1/2"
Rec'd Hose Size .....	1/2"	Avg. Air Consumption .....	17.7 cfm



## Michigan Pneumatic Model MP-6100I

### Inside Trigger Impact - 1" Square Drive

Features a through-hole anvil. Ideal for extra heavy-duty jobs, eliminating the use of hand wrenches. Efficient, heavy duty clutch allows fast rundown and high torque output. **Model MP-6100I-5SPLN with spline drive or MP-6100I6 with 6" extended anvil available. Uses brass end plates for longer wear. Parts are interchangeable with CP-610 impact.**

Square Drive .....	1"	Length .....	14-1/2"
Free Speed .....	4000 rpm	Weight .....	20 lbs.
Working Torque .....	1440 ft.-lbs.	Air Inlet Thread .....	1/2"
Rec'd Hose Size .....	1/2"	Avg. Air Consumption .....	17.7 cfm



## Nippon Pneumatic Model NAW-1200

### Right Angle Impact - 1/2" Square Drive

Features a pin-type anvil. Single hammer impact wrench is used in repair and garage work shops. Features a pin-type anvil and four steps of power control. This wrench is distinguished by its light weight, low air consumption and powerful impacting per blow. **Uses brass end plates for longer wear.**

Square Drive .....	1/2"	Length .....	14-11/32"
Free Speed .....	7000 rpm	Weight .....	6.6 lbs.
Working Torque .....	120 ft.-lbs.	Air Inlet Thread .....	1/4"
Angle Height .....	3-1/16"	Avg. Air Consumption .....	3.5 cfm



## Nippon Pneumatic Model NAW-19A

### Right Angle Impact - 3/4" Square Drive

Features a through-hole anvil. Right angle impact puts out the right amount of power for fast, effortless nutrunning of 3/4" nuts and bolts. Compact size and easy maneuverability permits nutrunning with minimum clearance. Built-in power regulator. **Uses brass end plates for longer wear.**

Square Drive .....	3/4"	Length .....	16-3/8"
Free Speed .....	4000 rpm	Weight .....	23.3 lbs.
Working Torque .....	470 ft.-lbs.	Air Inlet Thread .....	3/8"
Angle Height .....	5-13/16"	Avg. Air Consumption .....	17.7 cfm



## Michigan Pneumatic Model MP-3650RAN

### Right Angle Impact - 1" Square Drive

Features a through-hole anvil. This 90° angle impact will perform with a gear assembly designed to bear heavy pounding. Used anywhere a straight type won't reach. Offers the ultimate in power for hard, big, tough nutrunning jobs in hard to reach areas with a minimum of clearance. **Uses brass end plates for longer wear.**

Square Drive .....	1"	Length .....	17-3/8"
Free Speed .....	3500 rpm	Weight .....	39.6 lbs.
Working Torque .....	925 ft.-lbs.	Air Inlet Thread .....	1/2"
Angle Height .....	7-1/2"	Avg. Air Consumption .....	30 cfm

# Heavy-Duty Impact Wrenches



## Heavy-Duty Impacts



Model MP-1034EITH



Model MP-1040EITH



Model MP-1550EITH

Features a twin hammer clutch for more power per pound, a pressure fed clutch lubrication system, two piece motor housing for easy maintenance, a built-in muffler for low noise and direct drive for fast run down. **Parts are interchangeable with Ingersoll-Rand 2934, 2940 and 2950 series impact wrenches.**

Model No.	Shank Size	Handle Type	Torque Range	Length	Weight	Air Inlet Thread*	Avg. Air Consumption
MP-1034EITH MP-1034EOTH MP-1034EI5S MP-1034EO5S	1" Sq. Through-Hole 1" Sq. Through-Hole #5 Spline #5 Spline	Inside Trigger Outside Trigger Inside Trigger Outside Trigger	1100-1500 ft.-lbs.	11-1/4"	19 lbs.	1/2"	47 cfm
MP-1040EITH MP-1040EOTH MP-1040EI5S MP-1040EO5S	1" Sq. Through-Hole 1" Sq. Through-Hole #5 Spline #5 Spline	Inside Trigger Outside Trigger Inside Trigger Outside Trigger	1600-2000 ft.-lbs.	12-13/32"	22 lbs.	1/2"	58 cfm
MP-1550EITH MP-1550EOTH MP-1550EI5S MP-1550EO5S	1-1/2" Sq. Through-Hole 1-1/2" Sq. Through-Hole #5 Spline #5 Spline	Inside Trigger Outside Trigger Inside Trigger Outside Trigger	2500-3000 ft.-lbs.	14-1/2"	33 lbs.	1/2"	70 cfm

## Heavy-Duty Impacts



Model MP-1011EOTH



Model MP-1520EITH

Features a high energy per blow two jaw clutch, rugged steel clutch housing machined from bar stock, bronze alloy end plates for long motor life, a three piece housing for ease of maintenance, high power-to-weight ratio. **Parts are interchangeable with Chicago Pneumatic 611 and 6120 series impact wrenches.**

Model No.	Shank Size	Handle Type	Torque Range	Length	Weight	Air Inlet Thread*	Avg. Air Consumption
MP-1011EITH MP-1011EOTH MP-1011EI5S MP-1011EO5S	1" Sq. Through-Hole 1" Sq. Through-Hole #5 Spline #5 Spline	Inside Trigger Outside Trigger Inside Trigger Outside Trigger	1800-2800 ft.-lbs.	12-1/2"	22.50 lbs.	1/2"	47 cfm
MP-1520EITH MP-1520EI5S	1-1/2" Sq. Through-Hole #5 Spline	Inside Trigger	2500-3500 ft.-lbs.	14-3/4"	33.75 lbs.	1/2"	70 cfm



# Heavy-Duty Impact Wrenches



## Michigan Pneumatic Model 2920

### Pistol Impact - 3/4" Square Drive

Features a through-hole anvil. Rugged steel alloy hammer case machined from solid bar. Twin hammer mechanism for high power-to-weight ratio. **Model 2920-1 with a 1" through-hole anvil available. Parts are interchangeable with Ingersoll-Rand Model 2920P1.**

Square Drive .....	3/4"	Length .....	12-1/2"
Free Speed .....	5500 rpm	Weight .....	12 lbs.
Torque Range .....	800-1100 ft.-lbs.	Air Inlet Thread .....	3/8"
Rec'd Hose Size .....	1/2"	Avg. Air Consumption .....	38 cfm



## Michigan Pneumatic Model MP-7560

### Pistol Impact - 3/4" Square Drive

Features a through-hole anvil. Powerful two-jaw clutch and steel clutch housing design offers power and dependability. Adjustable power regulator for forward-reverse control built-in. **Parts are interchangeable with Chicago Pneumatic Model 6060SASAB. Model MP-7560-1 with a 1" through-hole anvil available.**

Square Drive .....	3/4"	Length .....	12-1/2"
Free Speed .....	3000 rpm	Weight .....	12 lbs.
Torque Range .....	560-1100 ft.-lbs.	Air Inlet Thread .....	3/8"
Rec'd Hose Size .....	1/2"	Avg. Air Consumption .....	38 cfm

## Extra Heavy-Duty Impacts



Model MP-1578

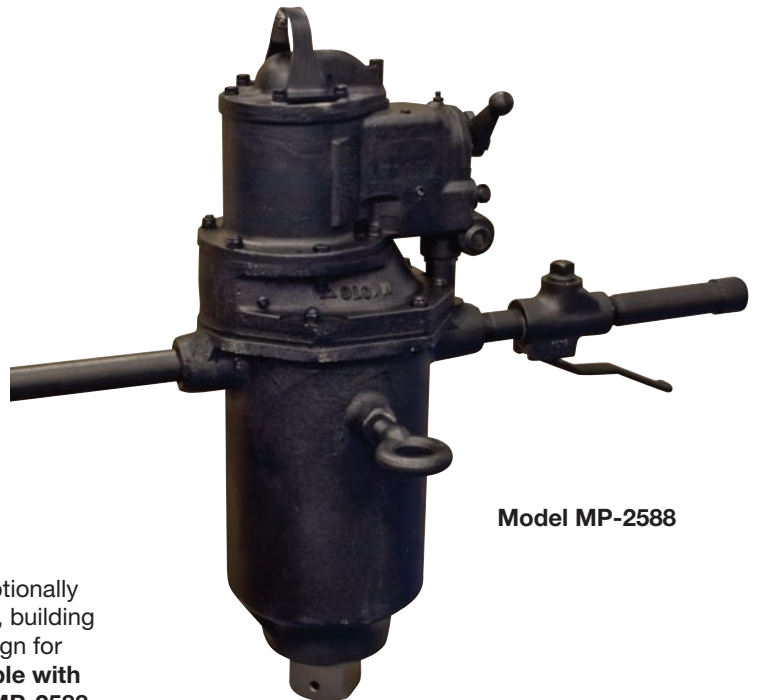

Model MP-2588

Features a through-hole anvil. Designed to produce an exceptionally high torque output. Effective for shipyards, bridge construction, building construction and heavy manufacturing plants. Time tested design for maximum durability. **Model MP-1578 parts are interchangeable with Ingersoll-Rand Models 578A1, 5780A1 and 5980A1. Model MP-2588 parts are interchangeable with Ingersoll-Rand Model 588.**

Model No.	Shank Size	Torque Range	Length	Weight	Rec'd Hose Size	Air Inlet Thread	Avg. Air Consumption
MP-1578	1-1/2" Sq. Through-Hole	5500-10000 ft.-lbs.	23"	86 lbs.	3/4"	3/4"	138 cfm
MP-2588	2-1/2" Sq. Through-Hole	25000-50000 ft.-lbs.	25-3/8"	215 lbs.	1"	1"	155 cfm

See pages 22-25 for impact accessories.

# Extra Heavy-Duty Impacts



Nippon Pneumatic Model NWH-500

## Extra Heavy-Duty Impact

Features a through-hole anvil. For extra heavy nutrunning jobs performed by slow and laborious hand wrench methods. Eliminates costly sledging, battering and burning of frozen nuts. Indispensable for production and maintenance jobs in shipyards, steel mills and heavy machinery manufacturing plants. Save manpower by using toolpower. **Uses brass end plates for longer wear.**

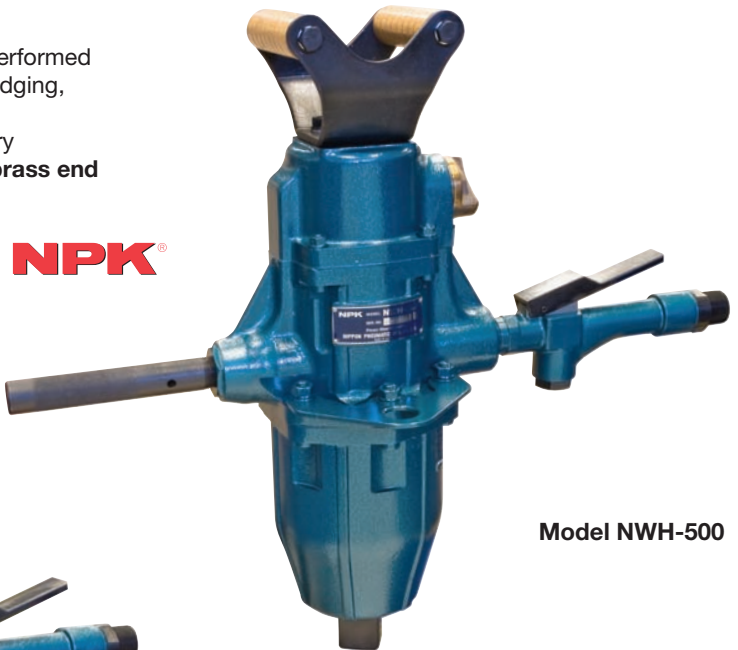

Model NWH-500

**NPK®**

**NPK®**



Model NWH-750-24

Nippon Pneumatic Model NWH-750-24

## Extra Heavy-Duty Impact

Features a through-hole anvil. Designed to produce an exceptionally high torque output. Effective for shipyards, bridge construction, building construction and heavy manufacturing plants. Lightweight aluminum housing allows the operator to manipulate this powerful tool in tight spaces. **Uses brass end plates for longer wear.**

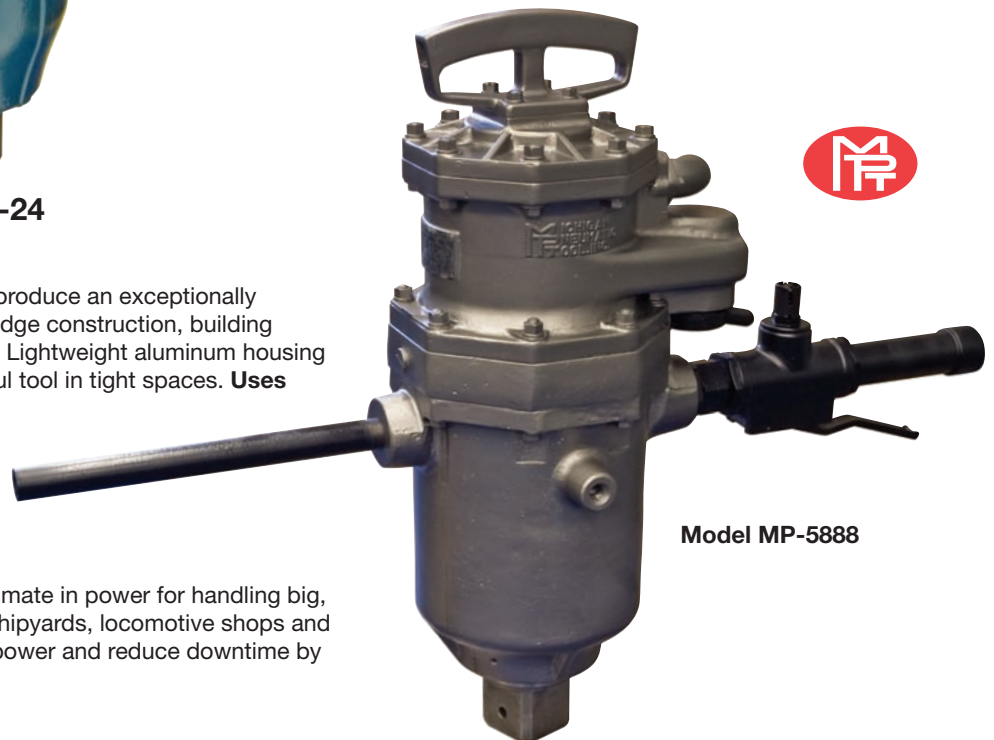

Model MP-5888



Michigan Pneumatic Model MP-5888

## Extra Heavy-Duty Impact

Features a through-hole anvil. Offers the ultimate in power for handling big, tough nutrunning and removal jobs. Used in shipyards, locomotive shops and heavy equipment industrial plants. Save manpower and reduce downtime by using tool power.

Model No.	Shank Size	Free Speed	Torque Range	Length	Weight	Rec'd Hose Size	Air Inlet Thread	Avg. Air Consumption
NWH-500	1-1/2" Sq.	3500 rpm	1800-4425 ft.-lbs.	22-3/16"	63.8 lbs.	3/4"		43 cfm
NWH-750-24	2-1/2" Sq.	2200 rpm	10000-15000 ft.-lbs.	25-7/16"	115.7 lbs.	3/4"	1"	53 cfm
MP-5888	2-1/2" Sq.	2600 rpm	7200-25000 ft.-lbs.	24-1/2"	167 lbs.	1"		85 cfm

# Pulsus Tools

Nippon Pneumatic

## Pistol Pulsus Wrench

- Ergonomic Grip
- Reduced Trigger Pull
- Unique Oil Bypass Port
- Single Blow per Revolution
- Significant Oil Life Extension

**N-DuraPulse**  
Manufactured by **NPK®**

The N-DuraPulse Series' unique single bypass inertia pulse mechanism delivers adjustable, yet stable, tightening torque while extending the oil life and decreasing the downtime for routine maintenance.

The ergonomic grip and reduced trigger pull also make this series more comfortable and less taxing for the operator.



Model NPP-06PTS



Model NPP-08PTS

**NPK®**

### Pulsus Wrench Specifications

Model No.	Shank Size	Retainer Type	Free Speed	Torque Range	Length	Weight	Rec'd Hose Size	Air Inlet Thread	Avg. Air Consumption
NPP-06PTS NPP-08PTS	3/8" Sq.	Pin-Type	6500 rpm	16-27 ft.-lbs. 26-37 ft.-lbs.	5-3/4" 6"	1.87 lbs. 1.96 lbs.	1/4"	1/4"	10.6 cfm

Nippon Pneumatic

## Automatic Shut-Off Pulsus Wrench



Model NPR-05PTS



Model NPR-06PTS



Model NPR-07PTS

**NPK®**

### Automatic Shut-Off Pulsus Wrench Specifications

Model No.	Shank Size	Retainer Type	Free Speed	Torque Range (soft joint)	Length	Weight	Rec'd Hose Size	Air Inlet Thread	Avg. Air Consumption
NPR-05PTS	3/8" Sq.	Pin-Type	6000 rpm	5-8 ft.-lbs.	6-1/2"	2.2 lbs.	1/4"	1/4"	12.4 cfm
NPR-06PTS	3/8" Sq.		6000 rpm	7-15 ft.-lbs.	6-3/4"	2.4 lbs.			12.4 cfm
NPR-07PTS	3/8" Sq.		5800 rpm	14-22 ft.-lbs.	6-3/4"	2.4 lbs.			12.4 cfm
NPR-08PTS	3/8" Sq.		5800 rpm	22-36 ft.-lbs.	7"	3.1 lbs.			15.9 cfm
NPR-09PTS	1/2" Sq.		5500 rpm	36-59 ft.-lbs.	7-11/16"	3.7 lbs.			17.7 cfm
NPR-10PTS	1/2" Sq.		5300 rpm	59-80 ft.-lbs.	7-11/16"	4.4 lbs.			19.4 cfm

## Pistol Pulsus Wrench & Screwdriver

# NPK®



**NPW-450A-DX0**  
1/4" Female Hex  
Pulsus Screwdriver



**NPW-650APTS-000**  
3/8" Sq. Drive  
Pulsus Wrench



**NPW-1600APTS-000**  
3/4" Sq. Drive  
Pulsus Wrench

**NPK's** "Pulsus" oil pulse mechanism tools feature a dual chambered air motor, which needs no lubrication and provides low vibration, low noise, and high durability. These lightweight, compact tools offer high performance and highly accurate tightening torque with easy torque adjustment. Other features include an ergonomic grip and a quick reverse that can be moved from the left side of the tool to the right side for left handed operation.

### Pulsus Wrench Specifications

Model No.	Shank Size	Retainer Type	Free Speed	Torque Range	Length	Weight	Rec'd Hose Size	Air Inlet Thread	Avg. Air Consumption
NPW-450APTS-000	3/8" Sq.	Pin-Type	6500 rpm	18-31 ft.-lbs.	6-1/16"	2.0 lbs.	1/4"	1/4"	10.6 cfm
NPW-550APTS-000	3/8" Sq.		6500 rpm	20-38 ft.-lbs.	6-1/4"	2.2 lbs.	3/8"		12.4 cfm
NPW-650APTS-000	3/8" Sq.		5500 rpm	32-47 ft.-lbs.	6-3/4"	2.3 lbs.	3/8"		15.9 cfm
NPW-800BPTS-000	3/8" Sq.		5300 rpm	47-69 ft.-lbs.	7"	3.2 lbs.	3/8"		17.7 cfm
NPW-1000APTS-000	1/2" Sq.		5300 rpm	52-81 ft.-lbs.	7-9/16"	4.2 lbs.	3/8"		19.4 cfm
NPW-1200APTS-000	1/2" Sq.		4200 rpm	66-101 ft.-lbs.	7-11/16"	5.1 lbs.	3/8"		21.2 cfm
NPW-1400APTS-000	1/2" Sq.		3500 rpm	87-123 ft.-lbs.	8-9/16"	6.2 lbs.	3/8"		28.3 cfm
NPW-1600APTS-000	3/4" Sq.		3000 rpm	95-155 ft.-lbs.	9-7/16"	7.9 lbs.	3/8"		31.8 cfm

### Pulsus Screwdriver Specifications

Model No.	Shank Size	Free Speed	Torque Range	Length	Weight	Rec'd Hose Size	Air Inlet Thread	Avg. Air Consumption
NPW-450A-DX0	1/4" Hex	6500 rpm	18-23 ft.-lbs.	6-3/16"	2.0 lbs.	3/8"	1/4"	10.6 cfm
NPW-550A-DX0			20-29 ft.-lbs.	6-5/16"	2.2 lbs.			12.4 cfm

## Automatic Shut-Off Pulsus Wrench & Screwdriver

# NPK®



**NPW-450A-TDX**  
1/4" Female Hex Pulsus Screwdriver

**NPW-800BPTS-T00**  
3/8" Sq. Drive Pulsus Wrench

**NPW-550APTS-T00**  
3/8" Sq. Drive Pulsus Wrench

**NPK's** "Pulsus" oil pulse mechanism tools feature a dual chambered air motor, which needs no lubrication and provides low vibration, low noise, and high durability. These lightweight, compact tools offer high performance and highly accurate tightening torque with easy torque adjustment. Other features include an ergonomic grip and a quick reverse that can be moved from the left side of the tool to the right side for left handed operation.

### Automatic Shut-Off Pulsus Wrench Specifications

Model No.	Shank Size	Retainer Type	Free Speed	Torque Range	Length	Weight	Rec'd Hose Size	Air Inlet Thread	Avg. Air Consumption
NPW-450APTS-T00	3/8" Sq.	Pin-Type	6000 rpm	15-21 ft.-lbs.	7-1/2"	2.9 lbs.	1/4"	1/4"	12 cfm
NPW-550APTS-T00			6000 rpm	19-29 ft.-lbs.	7-1/2"	2.9 lbs.	1/4"		12 cfm
NPW-650APTS-T00			5800 rpm	29-40 ft.-lbs.	8-1/8"	3.3 lbs.	3/8"		16 cfm
NPW-800BPTS-T00			5500 rpm	42-55 ft.-lbs.	8-3/8"	3.7 lbs.	3/8"		18 cfm

### Automatic Shut-Off Pulsus Screwdriver Specifications

Model No.	Shank Size	Free Speed	Torque Range	Length	Weight	Rec'd Hose Size	Air Inlet Thread	Avg. Air Consumption
NPW-450A-TDX	1/4" Hex	6000 rpm	15-20 ft.-lbs.	7-3/4"	2.9 lbs.	1/4"	1/4"	12 cfm
NPW-550A-TDX			19-24 ft.-lbs.	7-3/4"	3.0 lbs.	3/8"		

## Straight Pulsus Wrench & Screwdriver



**NPW-450EAPTS-000**  
3/8" Sq. Drive Straight Pulsus Wrench



**NPW-450EA-DX0**  
1/4" Female Hex Straight Pulsus Screwdriver



Model No.	Shank Size	Retainer Type	Free Speed	Torque Range	Length	Weight	Rec'd Hose Size	Air Inlet Thread	Avg. Air Consumption
NPW-450EAPTS-000	3/8" Sq.	Pin-Type	6000 rpm	14-20 ft.-lbs.	9-17/32"	1.9 lbs.	1/4"	1/4"	8.1 cfm
NPW-450EA-DX0	1/4" Hex	-		14-20 ft.-lbs.	9-19/32"				

## Straight Hydrotension Pulse Wrench



**NPW-60SPTS**  
3/8" Sq. Drive Straight Pulse Wrench



**NPW-80SPTS**  
3/8" Sq. Drive Straight Pulse Wrench



**NPW-100SPTS**  
1/2" Sq. Drive Straight Pulse Wrench



Model No.	Shank Size	Retainer Type	Free Speed	Torque Range	Length	Weight	Rec'd Hose Size	Air Inlet Thread	Avg. Air Consumption
NPW-50SPTS	3/8" Sq.	Pin-Type	9000 rpm	13-20 ft.-lbs.	8-1/8"	2.2 lbs.	1/4"	1/4"	7.1 cfm
NPW-60SPTS	3/8" Sq.		10500 rpm	15-28 ft.-lbs.	7-27/32"	2.3 lbs.	1/4"		7.1 cfm
NPW-80SPTS	3/8" Sq.		9000 rpm	19-35 ft.-lbs.	8-11/32"	2.9 lbs.	1/4"		8.8 cfm
NPW-100SPTS	1/2" Sq.		7500 rpm	30-58 ft.-lbs.	11-9/16"	4.4 lbs.	3/8"		10.6 cfm

## Pistol Hydrotension Pulse Wrench



**NPW-60PTS**  
3/8" Sq. Drive Pulse Wrench



**NPW-140PTS**  
1/2" Sq. Drive Pulse Wrench



**NPW-180PTS**  
3/4" Sq. Drive Pulse Wrench



Model No.	Shank Size	Retainer Type	Free Speed	Torque Range	Length	Weight	Rec'd Hose Size	Air Inlet Thread	Avg. Air Consumption
NPW-50PTS	3/8" Sq.	Pin-Type	9000 rpm	13-20 ft.-lbs.	6-25/32"	2.3 lbs.	1/4"	1/4"	7.1 cfm
NPW-60PTS	3/8" Sq.		10500 rpm	15-28 ft.-lbs.	5-25/32"	2.9 lbs.	1/4"		7.1 cfm
NPW-80PTS	3/8" Sq.		9000 rpm	19-35 ft.-lbs.	6-11/32"	3.2 lbs.	1/4"		8.8 cfm
NPW-100PTS	1/2" Sq.		7500 rpm	30-58 ft.-lbs.	7-1/4"	4.6 lbs.	3/8"		10.6 cfm
NPW-120PTS	1/2" Sq.		6000 rpm	40-74 ft.-lbs.	7-13/32"	5.3 lbs.	3/8"		10.6 cfm
NPW-140PTS	1/2" Sq.		5200 rpm	63-108 ft.-lbs.	7-5/8"	6.4 lbs.	3/8"		17.7 cfm
NPW-160PTS	1/2" Sq.		4500 rpm	81-130 ft.-lbs.	8-11/32"	7.5 lbs.	3/8"		17.7 cfm
NPW-180PTS	3/4" Sq.		4000 rpm	121-173 ft.-lbs.	8-21/32"	8.4 lbs.	3/8"		19.4 cfm



## Automatic Shut-Off Hydrotension Pulse Wrench

**NPK®**



**NPW-80TPTS**  
3/8" Sq. Drive Pulse Wrench



**NPW-160TPTS**  
1/2" Sq. Drive Pulse Wrench



**NPW-200TPTS**  
3/4" Sq. Drive Pulse Wrench

Model No.	Shank Size	Retainer Type	Free Speed	Torque Range	Length	Weight	Rec'd Hose Size	Air Inlet Thread	Avg. Air Consumption
NPW-60TPTS	3/8" Sq.	Pin-Type	9500 rpm	14-25 ft.-lbs.	6-25/32"	3.3 lbs.	1/4"	1/4"	7.1 cfm
NPW-80TPTS	3/8" Sq.		8000 rpm	17-31 ft.-lbs.	7-5/16"	3.6 lbs.	1/4"	1/4"	7.1 cfm
NPW-160TPTS	1/2" Sq.		4000 rpm	70-118 ft.-lbs.	9-11/16"	8.1 lbs.	3/8"	1/4"	15.9 cfm
NPW-180TPTS	3/4" Sq.		3600 rpm	107-155 ft.-lbs.	10"	9.2 lbs.	3/8"	1/4"	17.7 cfm
NPW-200TPTS	3/4" Sq.		3500 rpm	206-298 ft.-lbs.	10-15/16"	15.8 lbs.	1/2"	3/8"	19.4 cfm

**NPK®**



### Nippon Pneumatic Model TM-2000A Torque Meter

Useful for torque adjustment and control of hydrotension wrenches, calibrating torque wrenches and checking the torque of nutrunners. Features a digital display, high measurement accuracy, and a peak holding circuit for easy reading of displayed values. **Includes one 3/8" square socket adapter, one 1/2" square socket adapter and connecting cable.**

Measuring Range .....	0~199.9 Nm	Power Supply .....	AC 100/110V
Amplifier Weight .....	3.5 lbs.	Amp. Dimensions:	11" x 7-1/2" x 3-1/2"
Sensor Weight .....	14.3 lbs.	Sensor Dimensions:	7-1/2" x 4" x 3"



### Michigan Pneumatic Model MP-6100TA Torque Impact - 1" Square Drive

Features a **through-hole anvil**. Torque controlled impact provides easy torque adjustment and uniform torque output. "Auto-Stop" feature tightens bolts to pre-specified tension. When preset torque is reached, tool stops automatically. **Some MP-6100TA parts are interchangeable with the CP-610T impact.**

Square Drive .....	1"	Length .....	16-11/16"
Free Speed .....	4000 rpm	Weight .....	23.5 lbs.
Torque Range .....	300-1400 ft.-lbs.	Air Inlet Thread .....	1/2"
Rec'd Hose Size .....	1/2"	Avg. Air Consumption .....	17.7 cfm



### Michigan Pneumatic Model MP-6100TA-5SPLN Torque Impact - #5 Spline Drive

Features a **pin-type anvil**. Torque controlled impact provides easy torque adjustment and uniform torque output. "Auto-Stop" feature tightens bolts to pre-specified tension. When preset torque is reached, tool stops automatically. **Some MP-6100TA-5SPLN parts are interchangeable with the CP-610T impact.**

Spline Drive .....	#5	Length .....	17-1/16"
Free Speed .....	4000 rpm	Weight .....	23.7 lbs.
Torque Range .....	300-1400 ft.-lbs.	Air Inlet Thread .....	1/2"
Rec'd Hose Size .....	1/2"	Avg. Air Consumption .....	17.7 cfm

# Heavy-Duty Industrial Impact Sockets



## 3/8" Sq. Drive - 6 Point Hex

Size	Standard	Deep
5/16"	3810	3910
3/8"	3812	3912
7/16"	3814	3914
1/2"	3816	3916
9/16"	3818	3918
5/8"	3820	3920
11/16"	3822	3922
3/4"	3824	3924



## 1/2" Sq. Drive - 6 Point Hex, Metric

Size	Standard	Deep
10mm	48-10mm	49-10mm
11mm	48-11mm	49-11mm
12mm	48-12mm	49-12mm
13mm	48-13mm	49-13mm
14mm	48-14mm	49-14mm
15mm	48-15mm	49-15mm
16mm	48-16mm	49-16mm
17mm	48-17mm	49-17mm
18mm	48-18mm	49-18mm
19mm	48-19mm	49-19mm
20mm	48-20mm	49-20mm
21mm	48-21mm	49-21mm
22mm	48-22mm	49-22mm
23mm	48-23mm	49-23mm
24mm	48-24mm	49-24mm
25mm	48-25mm	-
26mm	48-26mm	-
27mm	48-27mm	49-27mm
28mm	48-28mm	-
29mm	-	49-29mm
30mm	48-30mm	49-30mm
32mm	48-32mm	49-32mm
34mm	-	49-34mm
35mm	-	49-35mm
36mm	48-36mm	49-36mm



## 3/8" Sq. Drive - 6 Point Hex, Metric

Size	Standard	Deep
6mm	38-06mm	39-06mm
7mm	38-07mm	39-07mm
8mm	38-08mm	39-08mm
9mm	38-09mm	39-09mm
10mm	38-10mm	39-10mm
11mm	38-11mm	39-11mm
12mm	38-12mm	39-12mm
13mm	38-13mm	39-13mm
14mm	38-14mm	39-14mm
15mm	38-15mm	39-15mm
16mm	38-16mm	39-16mm
17mm	38-17mm	39-17mm
18mm	38-18mm	39-18mm
19mm	38-19mm	39-19mm



## 1" Sq. Drive - 6 Point Hex

Size	Standard	Deep
3/4"	8824	8924
13/16"	8826	8926
7/8"	8828	8928
15/16"	8830	8930
1"	8832	8932
1-1/16"	8834	8933
1-1/8"	8836	8936
1-3/16"	8838	8938
1-1/4"	8840	8939
1-5/16"	8842	8942
1-3/8"	8844	8944
1-7/16"	8846	8946
1-1/2"	8848	8948
1-9/16"	8850	8950
1-5/8"	8852	8952
1-11/16"	8854	8954
1-3/4"	8856	8956
1-13/16"	8858	8958
1-7/8"	8860	8960
1-15/16"	8862	8962
2"	8864	8964
2-1/16"	8866	8966
2-1/8"	8868	8968
2-3/16"	8870	8970
2-1/4"	8872	8972
2-5/16"	8874	8974
2-3/8"	8876	8976
2-7/16"	8878	-
2-1/2"	8880	-
2-9/16"	8882	8981
2-5/8"	8884	-
2-11/16"	8886	-
2-3/4"	8888	8988
2-13/16"	8890	-
2-7/8"	8892	-
2-15/16"	8894	-
3"	8896	-
3-1/8"	8897	-
3-1/4"	8897A	-
3-3/8"	8898	-
3-1/2"	8899	-
3-5/8"	88116	-
3-7/8"	88124	-
4"	88128	-
4-1/8"	88132	-
4-1/4"	88136	-
4-1/2"	88144	-

## 3/4" Sq. Drive - 6 Point Hex

Size	Standard	Deep
9/16"	6818	6918
5/8"	6820	6920
11/16"	6822	6922
3/4"	6824	6924
13/16"	6826	6926
7/8"	6828	6928
15/16"	6830	6930
1"	6832	6932
1-1/16"	6834	6934
1-1/8"	6836	6936
1-3/16"	6838	6938
1-1/4"	6840	6940
1-5/16"	6842	6942
1-3/8"	6844	6944
1-7/16"	6846	6946
1-1/2"	6848	6948
1-9/16"	6850	6950
1-5/8"	6852	6952
1-11/16"	6854	6954
1-3/4"	6856	6956
1-13/16"	6858	6958
1-7/8"	6860	6960
1-15/16"	6862	6962
2"	6864	6964
2-1/16"	6890	-
2-1/8"	6892	6968
2-3/16"	6894	-
2-1/4"	6896	-
2-3/8"	6898	-

## 1/2" Sq. Drive - 6 Point Hex

Size	Standard	Deep
3/8"	4812	4912
7/16"	4814	4914
1/2"	4816	4916
9/16"	4818	4918
5/8"	4820	4920
11/16"	4822	4922
3/4"	4824	4924
13/16"	4826	4926
7/8"	4828	4928
15/16"	4830	4930
1"	4832	4932
1-1/16"	4834	4934
1-1/8"	4836	4936
1-3/16"	4838	4938
1-1/4"	4840	4940
1-5/16"	4842	4942
1-3/8"	4844	4944
1-7/16"	4846	4946
1-1/2"	4848	4948





# Heavy-Duty Industrial Impact Sockets



## #5 Spline Drive - 6 Point Hex

Female Dr.	Male Sq. Dr.	Part No.
7/8"	5828	-
15/16"	5830	-
1"	5832	-
1-1/16"	5834	5934
1-1/8"	5836	5936
1-3/16"	5838	5938
1-1/4"	5840	5940
1-5/16"	5842	5942
1-3/8"	5844	-
1-7/16"	5846	5946
1-1/2"	5848	5948
1-5/8"	5852	-
1-3/4"	5856	-
1-13/16"	5858	-
1-7/8"	5860	-
2"	5864	-
2-1/8"	Z9534	-

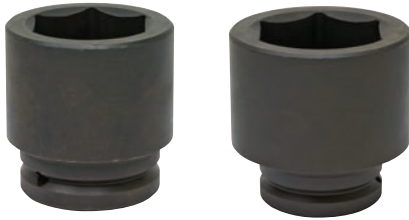

## 1-1/2" Sq. Drive - 6 Point Hex

Size	Standard	Deep
1-3/8"	84822	84922
1-7/16"	84823	84923
1-1/2"	84824	84924
1-9/16"	84825	84925
1-5/8"	84826	84926
1-11/16"	84827	84927
1-3/4"	84828	84928
1-13/16"	84829	84929
1-7/8"	84830	84930
1-15/16"	84831	84931
2"	84832	84932
2-1/16"	84833	84933
2-1/8"	84834	84934
2-3/16"	84835	84935
2-1/4"	84836	84936
2-5/16"	84837	84937
2-3/8"	84838	84938
2-7/16"	84839	84939
2-1/2"	84840	84940
2-9/16"	84841	84941
2-5/8"	84842	84942
2-11/16"	84843	84943
2-3/4"	84844	84944
2-13/16"	84845	84945
2-7/8"	84846	84946
2-15/16"	84847	84947
3"	84848	84948
3-1/16"	84849	84949
3-1/8"	84850	84950
3-3/16"	84851	84951
3-1/4"	84852	84952
3-5/16"	84853	84953
3-3/8"	84854	84954
3-7/16"	84855	84955
3-1/2"	84856	84956
3-9/16"	84857	84957
3-5/8"	84858	84958
3-11/16"	84859	84959
3-3/4"	84860	84960
3-13/16"	84861	84961
3-7/8"	84862	84962
3-15/16"	84863	84963
4"	84864	84964
4-1/16"	84865	84965
4-1/8"	84866	84966
4-3/16"	84867	84967
4-1/4"	84868	84968
4-5/16"	84869	84969
4-3/8"	84870	84970
4-7/16"	84871	84971
4-1/2"	84872	84972
4-5/8"	84874	84974
4-3/4"	84876	84976



## 2-1/2" Sq. Drive - 6 Point Hex

Size	Standard
1-3/4"	85814
1-7/8"	85815
2"	85816
2-1/8"	85817
2-1/4"	85818
2-3/8"	85819
2-9/16"	85820A
2-5/8"	85821
2-3/4"	85822
2-15/16"	85823
3"	85824
3-1/8"	85825
3-1/4"	85826
3-3/8"	85827
3-1/2"	85828
3-5/8"	85829
3-3/4"	85830
3-7/8"	85831
4"	85832
4-1/8"	85833
4-1/4"	85834
4-3/8"	85835
4-1/2"	85836
4-5/8"	85837
4-3/4"	85838
4-7/8"	85839
5"	85840
5-1/8"	85841
5-1/4"	85842
5-3/8"	85843
5-1/2"	85844
5-5/8"	85845
5-3/4"	85846
6-1/8"	85849
6-1/2"	85852
6-3/4"	85854
6-7/8"	85855
7-5/8"	85861
8"	85864

## Extension Bars

Female Dr.	Male Sq. Dr.	Part No.
3/8"	1/2"	3899
1/2"	3/8"	4900
1/2"	5/8"	A0810
1/2"	3/4"	4902
5/8"	1/2"	A1008
5/8"	3/4"	A1012
3/4"	1/2"	6900
3/4"	5/8"	A1210
3/4"	1"	6901
1"	3/4"	8900
1"	1-1/2"	8902
1"	#5 Spline	A1695
1-1/2"	1"	84900
1-1/2"	#5 Spline	A2495
#5 Spline	1"	5901
#5 Spline	1-1/2"	A9524



## Extension Bars

Size	Standard	Deep
3/8"	3"	3903
3/8"	6"	3906
1/2"	2"	4903
1/2"	5"	4905
1/2"	10"	4909
5/8"	7-1/2"	7185P
3/4"	7"	6907
3/4"	10"	6910
3/4"	13"	6913
1"	7-1/2"	8907
1"	10"	8910
1"	13"	8913
1"	4"	E1604
1-1/2"	8"	84908
1-1/2"	12"	84912
1-1/2"	15"	84915

Deep length, 12 point, metric and other sockets also available.

# Industrial Impact Wrench Accessories



## Impact Wrench Drill Chuck



Designed for use on standard impact tools.

Model	Description
1012C	1/2" Square Drive to 1/2" Chuck
1014C	3/8" Square Drive to 3/8" Chuck

## Universal Joints

Drive	Part No.
3/8"	3800
1/2"	4800
5/8"	U1010
3/4"	6800
1"	8800
1-1/2"	U2424
#5 Spline	U9595



## Hex Drive Shank Adapters



Converts slip chuck to square drive

Hex Drive	Sq. Drive	Length	Part No.
1/4"	1/4"	2"	250SH14-2
	1/4"	4"	250SH14-4
	1/4"	6"	250SH14-6
	3/8"	2"	250SH38-2
7/16"	3/8"	3"	437SH38-3
	3/8"	5"	437SH38-5
	1/2"	3"	437SH12-3
	1/2"	4"	437SH12-4
5/8"	1/2"	3"	EX502-3
	1/2"	5"	EX502-5
	5/8"	3"	7151-3
	5/8"	6"	7152-6
	3/4"	3"	EX758-3
	3/4"	5"	EX758-5

Other sizes and lengths available.

## Industrial-Duty Impact Socket Sets

### 6 pt. Standard 3/8" Drive

Set No. 313SS - 8 pieces (with tray)

Sizes: 5/16", 3/8", 7/16", 1/2",  
9/16", 5/8", 11/16", 3/4"



### 6 pt. Deep 3/8" Drive

Set No. 314SS - 8 pieces (with tray)

Sizes: 5/16", 3/8", 7/16", 1/2",  
9/16", 5/8", 11/16", 3/4"



### 6 pt. Standard 1/2" Drive

Set No. 411 - 11 pieces (with tray)

Sizes: 7/16", 1/2", 9/16", 5/8",  
11/16", 3/4", 13/16",  
7/8", 15/16", 1", 1-1/16"



### 6 pt. Deep 1/2" Drive

Set No. 412 - 11 pieces (with tray)

Sizes: 3/8", 7/16", 1/2", 9/16",  
5/8", 11/16", 3/4",  
13/16", 7/8", 15/16", 1"



### 6 pt. Deep 3/4" Drive

Set No. 608 - 8 pieces (tray not included)

Sizes: 7/8", 15/16", 1",  
1-1/16", 1-1/8", 1-1/4",  
1-5/16", 1-1/2"



### 6 pt. Deep 3/4" Drive

Set No. 609 - 9 pieces (tray not included)

Sizes: 3/4", 13/16", 7/8",  
15/16", 1", 1-1/16",  
1-1/8", 1-3/16", 1-1/4"



### 6 pt. Standard 3/4" Drive

Set No. IS-68 - 8 pieces (with metal tray)

Sizes: 1", 1-1/16", 1-1/8",  
1-1/4", 1-5/16", 1-3/8",  
1-7/16", 1-1/2"



## Michigan Pneumatic Model T01044BK

### Driver Set - 99 Pieces (with case)

- (8) PH: 0, 1, 2, 2, 2, 2, 2, 3
- (8) PZ: 0, 1, 2, 2, 2, 2, 2, 3
- (10) Star: T8, T10, T20, T25, T27, T30, T30, T40, T45
- (8) Star (tamper): T8, T10, T15, T20, T25, T27, T30, T40
- (9) Hex: 1.5, 2, 2.5, 3, 4, 5, 5.5, 6, 8mm
- (10) Hex: 1/16, 5/64, 3/32, 7/64, 1/8, 9/64, 5/32, 3/16, 7/32, 1/4"
- (6) Hex (tamper): 2, 2.5, 3, 4, 5, 6mm
- (4) Square: 0, 1, 2, 3
- (6) Hex (tamper): 5/64, 3/32, 7/64, 1/8, 9/64, 5/32"
- (3) Clutch: 1, 2, 3
- (3) Torq-set: 6, 8, 10
- (4) Tri-wing®: 1, 2, 3, 4
- (4) Spanner: 4, 6, 8, 10
- (3) Spline: M5, M6, M8
- (9) Slotted: 3, 4, 4.5, 5, 5.5, 6, 6.5, 7, 8mm
- (1) Coupler 1/4" Dr. x 1/4" Hex
- (1) 1/4" Dr. x H1/4" Aluminum Bit Holder
- (1) 1/4" Dr. Ratchet Head
- (1) Multihandle



Deep length, 12 point, metric and other sockets also available.



# Impact & Screwdriver Accessories

## Slotted Insert Bits

1/4" Hex

Screw Size	Part No.
1	250SS1
2	250SS2
3	250SS3
4	250SS4



## Phillips® Insert Bits

1/4" Hex

Screw Size	Part No.
0	250PB0
1	250PB1
2	250PB2
3	250PB3



## Bit Holder for 1/4" Hex Insert Bits

Magnetic

**MBHR14**

2-7/8" Length, 1/4" Hex Shank

Non-Magnetic

**BHR14**

2-7/8" Length, 1/4" Hex Shank



## Hex Socket Insert Bits

1/4" Hex



Screw Size		Hex Size	Part No.
Cap	Set		
0	3	1/20"	250H0
1	5-6	1/16"	250H1
2-3	8	5/64"	250H2
4-5	10	3/32"	250H3
-	1/4"	1/8"	250H5
10	5/16"	5/32"	250H7
1/4"	3/8"	3/16"	250H8
-	7/16"	7/32"	250H9
5/16"	1/2"	1/4"	250H10
3/8"	5/8"	5/16"	250H11
7/16" - 1/2"	3/4"	3/8"	250H12
-	-	2mm	74-2
-	-	3mm	74-3
-	-	4mm	74-4
-	-	5mm	74-5
-	-	6mm	74-6
-	-	8mm	74-8

**Additional types and models of bits available.**

## Slotted Power Bits

1/4" Hex



Screw Size	Overall Length	Part No.
1F-2R	1-15/16"	20-1S
2F-3R		20-2S
3F-4R		20-3S
4F-5R		20-4S
5F-6R		20-5S
6F-7R		20-7S
8F-10R		20-8S
10F-12R		20-9S
12F-14R		20-10S
1F-2R		3"
2F-3R	23-2S	
3F-4R	23-3S	
4F-5R	23-4S	
5F-6R	23-5S	
6F-7R	23-6S	
8F-10R	23-8S	
10F-12R	23-9S	
12F-14R	23-10S	

## Hex Socket Power Bits

1/4" Hex



Screw Size		Hex Size	Overall Length	Part No.
Cap	Set			
1	5-6	1/16"	1-15/16"	70-H1
2-3	8	5/64"		70-H2
4-5	10	3/32"		70-H3
-	1/4"	1/8"		70-H5
10	5/16"	5/32"		70-H7
1/4"	3/8"	3/16"		70-H8
-	7/16"	7/32"		70-H9
5/16"	1/2"-9/16"	1/4"		70-H10

## Phillips® Power Bits

1/4" Hex



Point Size	Overall Length	Part No.
1	1-15/16"	30-1P
2		30-2P
3		30-3P

## TORX® Power Bits

1/4" Hex



TORX® Size	Overall Length	Part No.
T8	1-15/16"	62-T8
T10		62-T10
T15		62-T15
T20		62-T20
T25		62-T25
T27		62-T27
T30		62-T30
T40		62-T40

Other types, sizes and lengths available.

# Reversible Screwdrivers



**NPK®**



## Nippon Pneumatic Model ND-6SDY

### Screwdriver - Impact Type

Heavy-duty straight impact driver for production fastening applications. Features a built-in power regulator and 1/4" slip chuck bit holder.

Screw Capacity .....	5/16"	Length .....	7-11/16"
Free Speed .....	6000 rpm	Weight .....	2.6 lbs.
Torque Range .....	159-442 in.-lbs.	Air Inlet Thread .....	1/4"
Rec'd Hose Size .....	1/4"	Avg. Air Consumption .....	5.3 cfm

**NPK®**



## Nippon Pneumatic Model ND-6HSX

### Screwdriver - Impact Type

Heavy-duty, high speed, high torque impact driver features a divertible rear exhaust, straight handle and easy to operate lever throttle. Also features a 1/4" slip chuck bit holder for rapid bit change.

Screw Capacity .....	5/16"	Length .....	8-11/16"
Free Speed .....	10500 rpm	Weight .....	2.1 lbs.
Torque Range .....	215-575 in.-lbs.	Air Inlet Thread .....	1/4"
Rec'd Hose Size .....	1/4"	Avg. Air Consumption .....	8.8 cfm

**NPK®**



## Nippon Pneumatic Model ND-5LPX

### Screwdriver - Impact Type

High speed impacting type screwdriver for heavy-duty production fastening applications. Lightweight and ergonomically balanced with a divertible exhaust for changing positions rapidly.

Screw Capacity .....	1/4"	Length .....	6-13/32"
Free Speed .....	11000 rpm	Weight .....	1.4 lbs.
Torque Range .....	160-200 in.-lbs.	Air Inlet Thread .....	1/4"
Rec'd Hose Size .....	1/4"	Avg. Air Consumption .....	5.3 cfm

**NPK®**



## Nippon Pneumatic Model ND-6HPAX

### Screwdriver - Impact Type

High torque impact driver featuring a 1/4" slip chuck bit holder for rapid bit change. Lightweight and easy to operate.

Screw Capacity .....	5/16"	Length .....	6-11/16"
Free Speed .....	8000 rpm	Weight .....	2.2 lbs.
Torque Range .....	250-575 in.-lbs.	Air Inlet Thread .....	1/4"
Rec'd Hose Size .....	1/4"	Avg. Air Consumption .....	8.8 cfm

**NPK®**



## Nippon Pneumatic Model ND-6LFAX

### Screwdriver - Impact Type

High torque pistol impact driver with a rapid forward and reverse thumb lever offers fast rundown of fasteners. Ideal for large wood screws or self-drilling and tapping screws.

Screw Capacity .....	1/4"	Length .....	6"
Free Speed .....	11000 rpm	Weight .....	1.8 lbs.
Torque Range .....	215-395 in.-lbs.	Air Inlet Thread .....	1/4"
Rec'd Hose Size .....	1/4"	Avg. Air Consumption .....	8.8 cfm



**Michigan Pneumatic Model MP-800-ST**

**Screwdriver - Adjustable Clutch**

Industrial, rear exhaust screwdriver is equipped with a quick change chuck for greater ease. An adjustable clutch provides a high degree of torque control through internal spring tension. Ideal for most applications.

Screw Capacity .....	1/4"	Length .....	10"
Free Speed .....	1800 rpm	Weight .....	2.5 lbs.
Torque Range .....	45-115 in.-lbs.	Air Inlet Thread .....	1/4"
Rec'd Hose Size .....	3/8"	Avg. Air Consumption .....	4 cfm



MP-525DD

**Michigan Pneumatic Model MP-525DD  
Model MP-527DD**

**Screwdriver - Direct Drive**

Reversible 1/4" hex nutrunner is ideal for maintenance and assembly. Equipped with QC-50 screwdriver attachment.

Model	MP-525DD	MP-527DD
Torque Range	19-55 in.-lbs.	35-75 in.-lbs.
Free Speed	2000 rpm	500 rpm
Rec'd Hose Size	1/4"	3/8"
Length	6-1/2"	7-1/2"
Weight	2.25 lbs.	3 lbs.



**Michigan Pneumatic Model MP-9905-ST**

**Screwdriver - Adjustable Clutch**

Lightweight screwdriver perfect for small parts rebuilding, metal and wood component work. Adjustable torque control is easily changed by tightening or loosening the control spring.

Screw Capacity .....	1/4"	Length .....	7-3/4"
Free Speed .....	1800 rpm	Weight .....	2.3 lbs.
Torque Range .....	20-60 in.-lbs.	Air Inlet Thread .....	1/4"
Rec'd Hose Size .....	3/8"	Avg. Air Consumption .....	4 cfm



**Michigan Pneumatic Model MP-0955-ST**

**Screwdriver - Positive Clutch**

Positive clutch screwdriver provides manually controlled clutch engagement and release by operator pressure on the tool. Ideal for applications where pull-up conditions require greater running torque than final torque. Great for overcoming difficult screwdriving jobs.

Screw Capacity .....	1/4"	Length .....	7"
Free Speed .....	1800 rpm	Weight .....	2.3 lbs.
Torque Range .....	45-115 in.-lbs.	Air Inlet Thread .....	1/4"
Rec'd Hose Size .....	3/8"	Avg. Air Consumption .....	4 cfm



**Michigan Pneumatic Model MP-7855-ST**

**Screwdriver - Adjustable Clutch**

Adjustable or cushion type clutch provides adjustable automatic torque control through internal spring tension on clutch jaws. This general purpose clutch is suitable for most applications.

Screw Capacity .....	1/4"	Length .....	7"
Free Speed .....	1800 rpm	Weight .....	2.5 lbs.
Torque Range .....	45-115 in.-lbs.	Air Inlet Thread .....	1/4"
Rec'd Hose Size .....	3/8"	Avg. Air Consumption .....	4 cfm

# Reversible & Shut-Off Screwdrivers



## Michigan Pneumatic Model MP-0909-ST

### Screwdriver - Adjustable Clutch

This tool provides full power performance with little maintenance. Ideal for production use where maximum power output is needed. Reversible with pressure actuated trigger.

Screw Capacity .....	1/4"	Length .....	8-1/4"
Free Speed .....	1500 rpm	Weight .....	1.3 lbs.
Torque Range .....	10-30 in.-lbs.	Air Inlet Thread .....	1/4"
Rec'd Hose Size .....	3/8"	Avg. Air Consumption .....	4 cfm



## Nippon Pneumatic Model SD-4

### Screwdriver - Adjustable Clutch

Industrial screwdriver features a push to start mechanism for greater operator control. Adjustable torque control is easily changed by tightening or loosening control spring. Lightweight for industrial applications.

Screw Capacity .....	3/16"	Length .....	8-3/4"
Free Speed .....	2000 rpm	Weight .....	1.3 lbs.
Torque Range .....	9-30 in.-lbs.	Air Inlet Thread .....	1/8"
Rec'd Hose Size .....	1/4"	Avg. Air Consumption .....	3 cfm



## Michigan Pneumatic Model MP-76-A

### Screwdriver - Positive Clutch

Lightweight screwdriver provides industrial quality at a low price. Excellent balance and a high torque mechanism. Good for small parts rebuilding, wood and metal component work, and auto service work. Reversible with pressure actuated trigger.

Screw Capacity .....	5/32"	Length .....	7-9/16"
Free Speed .....	9000 rpm	Weight .....	2.2 lbs.
Torque Range .....	12-20 in.-lbs.	Air Inlet Thread .....	1/8"
Rec'd Hose Size .....	1/4"	Avg. Air Consumption .....	3 cfm



## Michigan Pneumatic Model MP-000AR2LC12

### Screwdriver - Adjustable Clutch

Adjustable or cushion type clutch provides adjustable automatic torque control through internal spring tension on clutch jaws. This general purpose clutch is suitable for most applications.

Screw Capacity .....	#12	Length .....	8-3/4"
Free Speed .....	1850 rpm	Weight .....	2.25 lbs.
Torque Range .....	3-14 in.-lbs.	Air Inlet Thread .....	1/4"
Rec'd Hose Size .....	3/8"	Avg. Air Consumption .....	4 cfm



## Michigan Pneumatic Model MP-30P-IR

### Screwdriver - Adjustable Clutch

Cushion clutch is adjustable for accurate torque control. Once set, it will not tighten beyond the predetermined torque limit. Reduces work spoilage. **Parts are interchangeable with Ingersoll-Rand Model 00AR-2LCX21 screwdrivers.**

Screw Capacity .....	1/4"	Length .....	9-5/8"
Free Speed .....	1300 rpm	Weight .....	2.438 lbs.
Torque Range .....	20-90 in.-lbs.	Air Inlet Thread .....	1/8"
Rec'd Hose Size .....	3/8"	Avg. Air Consumption .....	4 cfm

# Reversible Shut-Off Screwdrivers



Michigan Pneumatic

## Straight Automatic Shut-Off Screwdrivers



MP-ST-1015



MP-ST-1807

### Straight Shut-Off Screwdriver Specifications

Model No.	Free Speed	Torque	Length	Weight	Rec'd Hose Size	Air Inlet Thread	Avg. Air Consumption
MP-ST-1011	1100 rpm	2 - 6 in.-lbs.	8"	0.6 lbs.	1/4"	1/8"	5.2 cfm
MP-ST-1015	1500 rpm	3.5 - 8.7 in.-lbs.	8"	0.6 lbs.	1/4"	1/8"	5.6 cfm
MP-ST-1409	900 rpm	9.6 - 17 in.-lbs.	8-1/2"	1.3 lbs.	1/4"	1/8"	7.0 cfm
MP-ST-1807	700 rpm	13 - 34.5 in.-lbs.	9-3/8"	1.8 lbs.	3/8"	1/4"	10.5 cfm
MP-ST-1817	1700 rpm	8.5 - 26 in.-lbs.	9-3/8"	1.8 lbs.	3/8"	1/4"	10.5 cfm
MP-ST-2208	800 rpm	26 - 52 in.-lbs.	10-1/2"	2.5 lbs.	3/8"	1/4"	17.5 cfm

Michigan Pneumatic

## Pistol Automatic Shut-Off Screwdrivers



MP-STP-1807



MP-200AS-ST



MP-STP-1011

The STP series torque control screwdrivers are compact and quiet. Die cast aluminum housing and balanced handle design combine to reduce operator fatigue. The STP Series features integrated trigger operated forward-reverse. **Model MP-200AS-ST and Model MP-201AS-ST include two extra springs for different torque ranges, depending on application.**

### Pistol Shut-Off Screwdriver Specifications

Model No.	Free Speed	Torque	Length	Weight	Rec'd Hose Size	Air Inlet Thread	Avg. Air Consumption
MP-STP-1011	1100 rpm	2 - 6 in.-lbs.	7"	1.10 lbs.	1/4"	1/4"	7.0 cfm
MP-STP-1015	1500 rpm	3.5 - 8.7 in.-lbs.	7-1/4"	1.40 lbs.	1/4"		7.0 cfm
MP-STP-1409	900 rpm	9.6 - 17 in.-lbs.	7-1/4"	1.80 lbs.	1/4"		10.5 cfm
MP-STP-1807	700 rpm	13 - 34.5 in.-lbs.	8-1/8"	2.40 lbs.	3/8"		17.5 cfm
MP-STP-1817	1700 rpm	8.5 - 26 in.-lbs.	8-1/8"	2.40 lbs.	3/8"		17.5 cfm
MP-STP-2208	800 rpm	26 - 52 in.-lbs.	8-7/8"	2.80 lbs.	3/8"		17.5 cfm
MP-201AS-ST	1100 rpm	3-40 in.-lbs.	8-5/16"	1.80 lbs.	3/8"	1/4"	4.0 cfm
MP-200AS-ST	550 rpm	2-45 in.-lbs.	8-3/4"	1.85 lbs.	3/8"		

# Angle & General Line Drills



## Michigan Pneumatic Model MP-31DR-ST

### 1/4" Air Drill - Reversible

Features a forward/reverse switch and a two-speed trigger. Durable composite motor housing and planetary gear system with needle bearings makes for a versatile, lightweight design well-suited for multiple applications. Replacement Jacobs SM1G61-T1 Multi-Craft® chuck available.

Drilling Capacity .....	1/4"	Length .....	5-13/16"
Free Speed .....	2600 rpm	Weight .....	1.30 lbs.
Spindle Thread .....	3/8"-24	Air Inlet Thread .....	1/4"
Rec'd Hose Size .....	1/4"	Avg. Air Consumption .....	4 cfm



## Michigan Pneumatic Model MP-1403

### 1/4" Palm Drill - Non-Reversible

Ideal for aircraft repair and maintenance work. Small and lightweight design to fit in the palm of the hand. Replacement Jacobs SM1G61-T1 Multi-Craft® chuck available.

Drilling Capacity .....	1/4"	Length .....	6-7/64"
Free Speed .....	3000 rpm	Weight .....	1.76 lbs.
Spindle Thread .....	3/8"-24	Air Inlet Thread .....	1/4"
Rec'd Hose Size .....	1/4"	Avg. Air Consumption .....	4 cfm



MP-2100-ST

## Michigan Pneumatic

### 3/8" Straight Drills - Non-Reversible

Designed with a three-way planetary gear reduction system for drilling the thickest metal or wood. Housed in a lightweight, rugged aluminum handle. Equipped with Jacobs SM1G61-T1 Multi-Craft® chuck.

Model	MP-2100-ST	MP-2145-ST
Drilling Capacity	3/8"	3/8"
Free Speed	2200 rpm	4500 rpm
Spindle Thread	3/8"-24	3/8"-24
Length	8-1/2"	8-1/4"
Weight	2 lbs.	2 lbs.
Air Inlet Thread	1/4"	1/4"
Avg. Air Consumption	4 cfm	4 cfm



3-3/4"

## Michigan Pneumatic Model MP-500AH-ST

### 3/8" Angle Drill - Non-Reversible

Right angle drill is designed to get into hard to reach areas where pistol types are not accessible. Durable and lightweight. Equipped with Jacobs SM4G61-T1 Multi-Craft® chuck.

Drilling Capacity .....	3/8"	Length .....	7-1/4"
Free Speed .....	1900 rpm	Weight .....	2 lbs.
Spindle Thread .....	3/8"-24	Air Inlet Thread .....	1/4"
Rec'd Hose Size .....	1/4"	Avg. Air Consumption .....	4 cfm



3-1/2"

## Michigan Pneumatic Model MP-510AH-ST

### 3/8" Angle Drill - Reversible

90° right angle drill is designed to get into hard to reach areas. Lightweight, compact, reversible, with variable speed control for most drilling applications. Equipped with Jacobs SM4G61-T1 Multi-Craft® chuck.

Drilling Capacity .....	3/8"	Length .....	8-1/4"
Free Speed .....	1400 rpm	Weight .....	2 lbs.
Spindle Thread .....	3/8"-24	Air Inlet Thread .....	1/4"
Rec'd Hose Size .....	1/4"	Avg. Air Consumption .....	4 cfm





## Michigan Pneumatic Model MP-31D-ST

### 1/4" Palm Drill - Non-Reversible

Ideal for aircraft repair and maintenance work. Small and lightweight design to fit in the palm of the hand. **Replacement Jacobs SM1G61-T1 Multi-Craft® chuck available.**

Drilling Capacity .....	1/4"	Length .....	5-5/8"
Free Speed .....	2800 rpm	Weight .....	1.3 lbs.
Spindle Thread .....	3/8"-24	Air Inlet Thread .....	1/4"
Rec'd Hose Size .....	1/4"	Avg. Air Consumption .....	4 cfm



## Michigan Pneumatic Model MP-7802-ST

### 3/8" Pistol Drill - Non-Reversible

Lightweight drill designed with a full planetary gearing system for hole sawing and precision drilling. Ideal for production use. **Equipped with Jacobs SM4G61-T1 Multi-Craft® chuck.**

Drilling Capacity .....	3/8"	Length .....	6-1/2"
Free Speed .....	2200 rpm	Weight .....	2.5 lbs.
Spindle Thread .....	3/8"-24	Air Inlet Thread .....	1/4"
Rec'd Hose Size .....	3/8"	Avg. Air Consumption .....	4 cfm



## Michigan Pneumatic Model MP-7803-ST

### 1/2" Pistol Drill - Non-Reversible

Lightweight drill designed with a full planetary gearing system for hole sawing and precision drilling. Ideal for production use. **Equipped with Jacobs SM8K61-T1 Multi-Craft® chuck and dead handle.**

Drilling Capacity .....	1/2"	Length .....	7"
Free Speed .....	500 rpm	Weight .....	4 lbs.
Spindle Thread .....	3/8"-24	Air Inlet Thread .....	1/4"
Rec'd Hose Size .....	3/8"	Avg. Air Consumption .....	4 cfm



## Michigan Pneumatic Model MP-525-ST

### 3/8" Pistol Drill - Reversible

Lightweight with a controllable teasing trigger. Features a 1/2 HP motor with a super quiet handle exhaust. Applications include screwdriving, honing and reaming. **Equipped with Jacobs SM4G61-T1 Multi-Craft® chuck. QC-50 1/4" hex screwdriver adapter available.**

Drilling Capacity .....	3/8"	Length .....	6-1/2"
Free Speed .....	2000 rpm	Weight .....	2.5 lbs.
Spindle Thread .....	3/8"-24	Air Inlet Thread .....	1/4"
Rec'd Hose Size .....	1/4"	Avg. Air Consumption .....	4 cfm



## Michigan Pneumatic Model MP-527-ST

### 1/2" Pistol Drill - Reversible

Double geared drill handles the toughest chores. Features a teasing action trigger for speed control. Great for screwdriving, tapping and hole sawing. **Equipped with Jacobs SM8K61-T1 Multi-Craft® chuck and dead handle. QC-50 1/4" hex screwdriver adapter available.**

Drilling Capacity .....	1/2"	Length .....	7-1/2"
Free Speed .....	500 rpm	Weight .....	3.25 lbs.
Spindle Thread .....	3/8"-24	Air Inlet Thread .....	1/4"
Rec'd Hose Size .....	3/8"	Avg. Air Consumption .....	4 cfm

# Aircraft Drills



Michigan Pneumatic

## 45° & 90° Angle Drills - Non-Reversible



MP-9030



MP-3045



MP-9030EXT



MP-9030EXT-45



**Features rear exhaust.** Milled motor housing, steel alloy cylinder and rotor for long tool life. Available in standard or extended length head with 45° or 90° angle. Precision machined for smooth and quiet operation. **Models MP-9039EXT and MP-9039EXT-45 with 9/32"-40 internal spindle thread also available. (Bit not included.)**

Model No.	Head Angle	Drilling Capacity	Free Speed	Internal Spindle Thread	Length	Weight	Rec'd Hose Size	Air Inlet Thread	Avg. Air Consumption
MP-9030	90°	1/4"	3000 rpm	1/4"-28	10-11/16"	1.90 lbs.	1/4"	1/4"	7.0 cfm
MP-3045	45°				10-29/32"	1.90 lbs.			
MP-9030EXT	90°				13-3/8"	2.00 lbs.			
MP-9030EXT-45	45°				14-7/8"	2.00 lbs.			



### Michigan Pneumatic Model MP-3603

#### 360° Drill - Non-Reversible



3-1/4"

Bit not included

Lightweight, powerful drill ideal for aircraft and sheet metal repair. Designed for 1/4"-28 threaded bits. Features a rear exhaust and easy maneuverability to minimize operator fatigue. Milled motor housing, steel alloy cylinder and rotor for long tool life.

Drilling Capacity .....	1/4"	Length .....	10-5/8"
Free Speed .....	3000 rpm	Weight .....	2.0 lbs.
Spindle Thread .....	1/4"-28 Internal	Air Inlet Thread .....	1/4"
Rec'd Hose Size .....	1/4"	Avg. Air Consumption .....	7 cfm



### Michigan Pneumatic Model MP-FD30261

#### 360° Drill - Non-Reversible

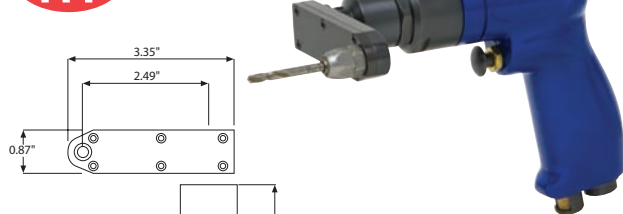

Bit not included

Smooth, quiet design featuring steel alloy cylinder and rotor. Feather trigger for better control. Head may be adjusted to desired angle. **Model MP-FD30161 with straight handle available.**

Drilling Capacity .....	1/4"	Length .....	7"
Free Speed .....	3000 rpm	Weight .....	2.0 lbs.
Spindle Thread .....	1/4"-28 Internal	Air Inlet Thread .....	1/4"
Rec'd Hose Size .....	1/4"	Avg. Air Consumption .....	4 cfm

# Aircraft Drill Accessories



Michigan Pneumatic **Model MP-309**

## Cleco Installation Tool

Ideal for aircraft production assembly and mechanics. Quickly install button type and side grip temporary fasteners. Feather trigger and quiet operation round out the features.



Shown with Cleco fastener (not included.)

Length ..... 5-1/2"  
 Weight ..... 1.25 lbs.  
 Rec'd Hose Size ..... 1/4"  
 Air Inlet Thread ..... 1/4"

## High Speed Drill Bits - 135° Threaded Shank

Produced from Industrial-Grade Steel. Split point penetrates on contact and prevents "walking" of bit. Designed for steel (low and medium carbon), steel alloy and stainless steel. **Long and Stubby lengths also available.**

- HSS designed for cast iron and steel alloy.
- Cobalt designed for steel (low and medium carbon), steel alloy, and stainless steel alloys.



High Speed Steel Part No.	Cobalt Steel Part No.	Size	Decimal Equivalent	Overall Length
325-40	625-40	#40	0.0980	1"
325-0.125	625-0.125	1/8"	0.1250	1-1/4"
325-30	625-30	#30	0.1285	
325-27	625-27	#27	0.1440	
325-0.1562	625-0.1562	5/32"	0.1562	
325-21	625-21	#21	0.1590	1-1/4"
325-20	625-20	#20	0.1610	
325-16	625-16	#16	0.1770	
325-13	625-13	#13	0.1850	
325-0.1875	625-0.1875	3/16"	0.1875	1-1/4"
325-11	625-11	#11	0.1910	
325-10	625-10	#10	0.1935	
325-0.25	625-0.25	1/4"	0.2500	
325-F	625-F	"F"	0.2570	

## 100° Countersink Cutters

Fits any micro-stop counter sink or angle drill with a 1/4"-28 spindle. Cutter and integral pilot are precision ground.



Pilot Size	Body Diameter		
	7/16"	3/8"	1/2"
#40	328-40	328-38-40	328-12-40
#30	328-30	328-38-30	328-12-30
#27	328-27	-	-
#21	328-21	328-38-21	328-12-21
#10	328-10	328-38-10	328-12-10
1/4"	328-0.25	-	-

## Drill Stops

Helps eliminate the worry of drilling too deep into tubing, wiring, etc.



DS47-1



DS47-2

Part No.	Size	Decimal Equivalent
DS47-0	#50	0.0700
DS47-1	#40	0.0980
DS47-2	#30	0.1285
DS47-22	#27	0.1440
DS47-3	#21	0.1590
DS47-4	#20	0.1610
DS47-42	#16	0.1770
DS47-5	#12	0.1890
DS47-6	#10	0.1935
DS47-7	1/4"	0.2500
DS47-8	5/16"	0.3150

## Micro-Stop Countersinks



### MPT727 - Mini

Designed to be operated in angle drills with a 1/4"-28 spindle. Features a 3/32" shaft travel and a 9/16" cutter capacity. Adjustable in 0.001 increments and rated for use up to 3000 rpm.

### MPT827 - Standard

Features 1/4" shank with 9/32" travel. Will accept up to 1/2" diameter cutters with a 1/4"-28 thread. Rated for up to 3000 rpm and is adjustable in 0.001 increments.

### MPT927 - Ball Bearing

The ball bearing style micro-stop countersink featuring same specifications as **Model MPT827**. Rated for up to 10000 rpm.



**MP-719T Drill**  
Motor Detail

**Michigan Pneumatic Model MP-719T w/ Bubble Level**

**Floor Drill**

This drill driver is ideal for self-drilling and self-tapping screws in the truck and trailer industries. Features a lower rpm for higher driving and stall torque. Equipped with Jacobs 33BA-1/2 medium-duty chuck and bubble level.

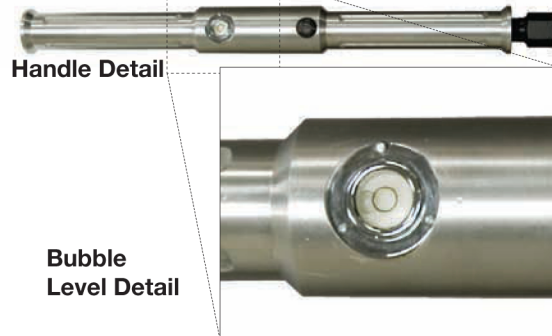

Drilling Capacity .....	1/2"	Length .....	32-1/2"
Free Speed .....	1500 rpm	Weight .....	11 lbs.
Spindle Thread .....	1/2"-20	Rec'd Hose Size .....	3/8"
Width of Motor.....	2-3/4"	Air Inlet Thread .....	3/8"
Width w/ Handle.....	17-3/4"	Avg. Air Consumption .....	26 cfm



**Michigan Pneumatic Model MP-8009**

**3/8" Heavy-Duty Drill - Non-Reversible**

Heavy-duty drill ideal for the aircraft industry. Small, lightweight design fits comfortably in the operator's hand. Ease of handling and control ensures optimal drilling performance. **Parts are interchangeable with the ARO Model 7364-D drill.** Equipped with Jacobs 22BA-3/8 industrial-duty chuck.

Drilling Capacity .....	3/8"	Length .....	7"
Free Speed .....	3000 rpm	Weight .....	2.5 lbs.
Spindle Thread .....	3/8"-24	Air Inlet Thread .....	1/4"
Rec'd Hose Size .....	3/8"	Avg. Air Consumption .....	4 cfm



# Industrial-Duty Drills

**NPK®**



## Nippon Pneumatic Model NRD-6SAT

### 1/4" Straight Drill - Non-Reversible

Compact, lightweight drill fits the palm of the hand. Features a lever throttle for safe, easy start up. Ideal for hard to reach drilling areas. Planetary gearing provides sufficient torque for light reaming applications. **Equipped with Jacobs 1B-3/8 medium-duty chuck.**

Drilling Capacity .....	1/4"	Length .....	6-17/32"
Free Speed .....	2800 rpm	Weight .....	1.8 lbs.
Spindle Thread .....	3/8"-24	Air Inlet Thread .....	1/4"
Rec'd Hose Size .....	1/4"	Avg. Air Consumption .....	17.7 cfm

**NPK®**



## Nippon Pneumatic Model NRD-6PBT

### 1/4" Heavy-Duty Drill - Non-Reversible

Ideal for aircraft and sheet metal repair. Lightweight industrial drill with a teasing throttle for starting holes. Exhausts through the handle to avoid blowing debris. **Equipped with Jacobs 1B-3/8 medium-duty chuck.**

Drilling Capacity .....	1/4"	Length .....	5-7/8"
Free Speed .....	2400 rpm	Weight .....	1.8 lbs.
Spindle Thread .....	3/8"-24	Air Inlet Thread .....	1/4"
Rec'd Hose Size .....	1/4"	Avg. Air Consumption .....	17.7 cfm

**NPK®**



## Nippon Pneumatic Model NRD-10PT

### 3/8" Heavy-Duty Drill - Non-Reversible

Production drill designed for use on assembly and maintenance applications. Bronze end plates ensure long life and durability. Power-to-weight ratio exceeds similar models. **Equipped with Jacobs 22BA-3/8 industrial-duty chuck.**

Drilling Capacity .....	3/8"	Length .....	6-1/8"
Free Speed .....	2000 rpm	Weight .....	2.4 lbs.
Spindle Thread .....	3/8"-24	Air Inlet Thread .....	1/4"
Rec'd Hose Size .....	1/4"	Avg. Air Consumption .....	19.4 cfm

**NPK®**



## Nippon Pneumatic Model NRD-12PAT

### 1/2" Heavy-Duty Drill - Non-Reversible

Heavy-duty drill built to take the punishment of continuous production use. Rugged design assures the best possible drilling performance. Smoothness allows for accurate drilling, reaming and tapping. Adjustable handle included. **Equipped with Jacobs 33BA-1/2 heavy-duty chuck.**

Drilling Capacity .....	1/2"	Length .....	7-3/8"
Free Speed .....	1500 rpm	Weight .....	5.7 lbs.
Spindle Thread .....	1/2"-20	Air Inlet Thread .....	1/4"
Rec'd Hose Size .....	3/8"	Avg. Air Consumption .....	23 cfm

**NPK®**



## Nippon Pneumatic Model NRT-8P

### Reversible Tapper

**Industrial model.** Double trigger tapper with two-step quick reverse throttle makes tapping work speedy, leaving a fine finish. **Equipped with NPK Model 6551010080 medium-duty chuck. Model NRT-8P-JTC with Jacobs Tap Chuck available.**

657000080 Chuck Key

Capacity .....	5/16"	Length .....	7-1/16"
Free Speed .....	1700 rpm	Weight .....	2.6 lbs.
Spindle Thread .....	#1 Jacobs Taper	Air Inlet Thread .....	1/4"
Rec'd Hose Size .....	3/8"	Avg. Air Consumption .....	19.4 cfm



NRT-8P-JTC

Tap not included

# Heavy-Duty Drills & Wood Borers



## Step 1. Select Motor No.

Motor No.	Free Speed	Capacity	
		Drilling	Reaming/Tapping
NRD-14R NRD-14RU*	1100 rpm	9/16"	3/8"
NRD-16R NRD-16RU*	900 rpm	5/8"	1/2"
NRD-19R NRD-19RU*	750 rpm	3/4"	5/8"
NRD-22R NRD-22RU*	600 rpm	7/8"	3/4"

\* Underwater Motor



NRD-19RWSCT

Nippon Pneumatic

## Heavy-Duty Reversible Drills

Ideal for production work, boasting smooth operation for accurate drilling, reaming, tapping and woodboring. Possesses the lugging power to maintain speed when under load. Powerful and efficient for use in railroad shops, shipyards, tool rooms and all types of construction work. Features ball bearing support for long life. **Includes dead handle. Equipped with 1/2" Air Inlet Thread requiring Avg. Air Consumption of 39 cfm. Recommended hose size of 1/2".**

- Built-In Lubricator
- 2 Horse Power Motor, 2-3/8" Feed Length

## Example for Ordering

MOTOR NO.	SPINDLE FEED OPTION	THROTTLE OPTION	REAR FEED OPTION	MODEL NO. FOR ORDERING
<b>NRD-19R</b> Step 1	+ <b>W</b> Step 2	+ <b>SCT</b> Step 3	+ <b>**</b> Step 4	= <b>NRD-19RWSCT</b>

\*\*Rear Feed Option omitted per Option Code B exception

## Step 2. Select Spindle Option



Option Code	Ordering Exceptions
#1 Morse Taper	NRD-14 Series only (Standard: do not specify)
2M	NRD-16 thru NRD-22 (Standard: do not specify)
5C	NRD-14 Series thru NRD-22 Series
6C or 7C	NRD-19 and NRD-22 Series only
W	Includes Breast Plate (Step 4)

## Step 3. Select Throttle Option

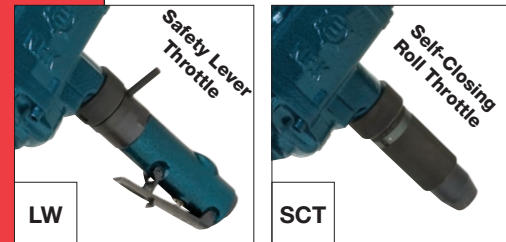

## Step 4. Select Rear Feed Option



Option Code	Ordering Exceptions
Feed Screw	Standard: do not specify
B	Included with Option W (Step 2)

# Heavy-Duty Drills & Wood Borers



## Step 1. Select Motor No.

Motor No.	Free Speed	Capacity	
		Drilling	Reaming/ Tapping
NRD-23R NRD-23RU*	700 rpm	15/16"	3/4"
NRD-25R NRD-25RU*	570 rpm	1"	7/8"
NRD-28R NRD-28RU*	450 rpm	1-1/8"	7/8"
NRD-32LR NRD-32LRU*	380 rpm	1-1/4"	1"

\* Underwater Motor



NRD-23RSC

Nippon Pneumatic

## Heavy-Duty Reversible Drills

Heavy-duty reversible drills are preferred for production work as they have absolute smoothness of operation for accurate drilling, reaming, tapping and nutrunning. They possess the lugging power to keep their speed when under a load. Their power and efficiency makes them ideal tools for use in railroad shops, shipyards, tool rooms and all types of construction work. Features ball bearing support for long life. **Includes dead handle. Equipped with 3/8" (Safety Lever Throttle) or 1/2" (Self-Closing Roll Throttle) Air Inlet Thread requiring Avg. Air Consumption of 50 cfm. Recommended hose size of 1/2".**

- Built-In Lubricator
- Spindle Protection Nut (2M and 3M Spindles only)
- 3 Horse Power, 4" Feed Length

## Example for Ordering

MOTOR NO.	SPINDLE FEED OPTION	THROTTLE OPTION	REAR FEED OPTION	MODEL NO. FOR ORDERING
<b>NRD-23R</b> Step 1	+	<b>*</b> Step 2	+	<b>SCT</b> Step 3
		+	<b>**</b> Step 4	=
				<b>NRD-23RSC</b>

\*Spindle Feed Option omitted per Option Code 2M exception \*\*Rear Feed Option omitted per exception

See pages 38-39 & 42 for drill accessories.

## Step 2. Select Spindle Option



Option Code	Ordering Exceptions
2M	NRD-23 Series (Standard: do not specify)
3M	NRD-25 thru NRD-32 (Standard: do not specify)
W	Includes Breast Plate (Step 4)

## Step 3. Select Throttle Option

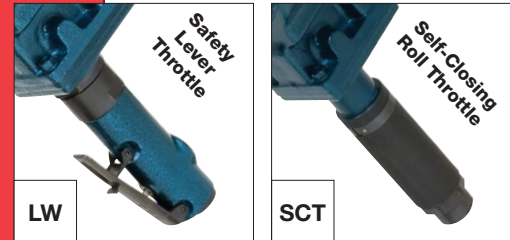

## Step 4. Select Rear Feed Option



Option Code	Ordering Exceptions
Feed Screw	Standard: do not specify
B	Included with Option W (Step 2)

# Heavy-Duty Drill Accessories



## Morse Taper Arbors



Model	Taper	Drive
A0261	#2 Morse	3/8"-24 Threaded
A0264	#2 Morse	1/2"-20 Threaded
A0268	#2 Morse	5/8"-16 Threaded
R33W-151-0.50	#2 Morse	Woodboring Chuck
R33SW-151A-0.50	#3 Morse	Woodboring Chuck
2MTX12SQ	#2 Morse	1/2" Square
3MTX12SQ	#3 Morse	1/2" Square
3MTX34SQ	#3 Morse	3/4" Square
33SH-214	#3 Morse	3/4" Square
5MTX1SQ	#5 Morse	1" Square

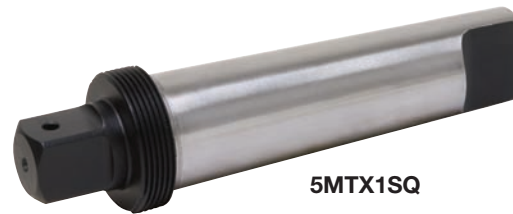

## MP-222 Accessories



## Other Manufacturer Accessories



## Jacobs® Arbors

Morse taper to Jacobs® taper arbors can be used to adapt any Morse taper drill to accept Jacobs® chucks. These adapters improve drill operation and make drill bit changes quicker.

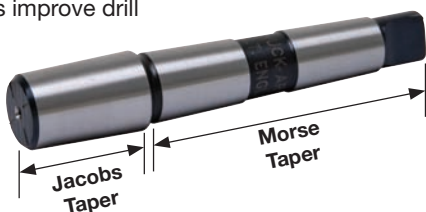

Jacobs® Taper	#1 Morse Taper	#2 Morse Taper	#3 Morse Taper	#4 Morse Taper	#5 Morse Taper
	Model	Model	Model	Model	Model
1JT	A0101	A0201	A0301	-	-
2JT	A0102	A0202	A0302	A0402	-
3JT	-	A0203	A0303	A0403	A0503
4JT	-	A0204	A0304	A0404	A0504
5JT	-	-	A0305	A0405	A0505
6JT	A0106	A0206	A0306	A0406	-
33JT	A0133	A0233	A0333	A0433	-





## Jacobs® Tap Chucks

Full range of tap chucks for tapping machines and portable tappers.

- Designed for use with **Rubber-Flex®** collets
- Positive-drive chuck jaws for superior performance
- Simple quarter turn of chuck screw to disengage back jaws



### Tap Chuck Specifications

Model No.	Tap Capacity	Mount Style	Overall Length	Maximum Diameter	Round Shank Capacity		Available Rubber-Flex® Collets †	Weight
					Minimum	Maximum		
41-01	# 0-1/4"	1JT*	2.00"	0.84"	0.09"	0.25"	J116, J117	2 oz
42-01	#10-5/16"	1JT*	2.50"	1.06"	0.09"	0.38"	J420, J421, J422, J423	6 oz
42-02	#10-5/16"	2 short JT*	2.50"					5 oz
42-24	#10-5/16"	0.3675 Dia.	2.50"					6oz
42-J8	#0-1/4"	0.375 Sq. Hole	2.31"					6 oz
44-02	5/16-5/8"	2JT*	3.12"	1.47"	0.11"	0.50"	J440, J441, J443	12 oz
44-06	5/16-5/8"	6JT*						
44-J9	#10-1/2"	0.500 Sq. Hole						

\* Jacobs® Taper

† Rubber-Flex® Collets are not included. Must be ordered separately.

## Jacobs® Rubber-Flex® Collets

Outperform conventional split-steel collets in gripping power, accuracy and durability.

- Durable one-piece construction
- Precision ground steel jaw inserts assuring maximum grip
- Seals collets and machine spindles to protect from abrasive particles

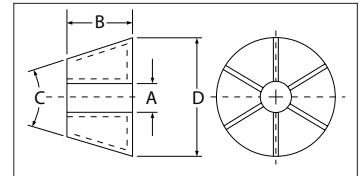

### Rubber-Flex® Collet Specifications

Model No.	Capacity Range (A)		Contact Length (B)	Cone Angle (C)	Outside Diameter (D)	Number of Inserts
	Minimum	Maximum				
J116	0.094"	0.177"	0.468"	26°	0.590"	6
J117	0.177"	0.256"				8
J420	0.176"	0.320"	0.500"	40°	0.941"	6
J421	0.139"	0.257"				6
J422	0.253"	0.383"				6
J423	0.090"	0.180"				4
J440	0.280"	0.500"	0.630"	45°	1.296"	6
J441	0.176"	0.383"	0.630"		1.296"	6
J443	0.110"	0.280"	0.620"		1.180"	4

### Replacement Parts

Model No.	Nut	Rubber-Flex® Collet	Back Jaws	Nut Wrench	Body Wrench
41-01	N410	J116, J117	U400	K400N	K400B
42-01	N421	J420, J421, J422, J423	U420	K420N	K420B
42-02					K420B
42-J8					None
42-24					K420B
44-02	N441	J440, J441, J443	U440	K440N	K420N
44-06					K420N
44-J9					None



### Michigan Pneumatic Model MP-6-1015-0075

#### Nutrunner - 3/4" Square Drive

Lightweight nutrunner featuring high stall torque and reversible drive is ideal for turning valves, tightening, tapping, reaming, pipe beveling or expanding. Compact angle head allows access to confined spaces. Worm gear drive provides high torque and reliability. **Equipped with 3/4" square drive.**  
**363394910** 1/2" Square Drive Spindle

Square Drive .....	3/4"	Length .....	21"
Free Speed .....	50 rpm	Weight .....	11 lbs.
Stall Torque .....	423 ft.-lbs.	Air Inlet Thread .....	3/8"
Rec'd Hose Size .....	1/2"	Avg. Air Consumption .....	45 cfm



### Michigan Pneumatic Model MP-9072RT

#### Right Angle Rolling Motor

Torque-controlled rolling motor designed for the boiler tube industry. Unique head design features enclosed bearing design for long tool life. Engineered to precisely expand tubes in steam drums, fire tubes, and related boiler equipment. **Features a roll throttle. Includes dead handle. Tube OD capacity: 1-1/2" to 4".**

Square Drive .....	3/4"	Length .....	21-3/4"
Free Speed .....	90 rpm	Weight .....	14.75 lbs.
Torque Range .....	150-305 ft.-lbs.	Air Inlet Thread .....	1/2"
Rec'd Hose Size .....	3/4"	Avg. Air Consumption .....	90 cfm

# Heavy-Duty Drills & Wood Borers



Michigan Pneumatic Model MP-222

## Extra Heavy-Duty Drill/Wood Borer

The newest edition to the MPT line of industrial air tools. Ideal for woodboring in marine timbers and railroad repair work. Features include ball bearing support for long life and efficient operation, a graduated roll throttle for speed control, and durable spur gearing. **Includes breast plate, dead handle and a built-in lubricator standard. Equipped with 1/2" Air Inlet Thread requiring Average Air Consumption of 50 cfm. Recommended hose size of 1/2"**



MP-222KWA1

### Step 1. Select Motor No.

Motor No.	Free Speed	Capacity	
		Drilling	Reaming/Tapping
MP-222J	1025 rpm	9/16"	3/8"
MP-222K	750 rpm	9/16"	7/16"
MP-222M	350 rpm	7/8"	5/8"

### Step 2. Select Spindle Option

A1	A4	A5
A2	A3	WA1
Option Code	Ordering Exceptions	
A5	MP-222M Series only	

### Example for Ordering

MOTOR NO.	SPINDLE FEED OPTION	MODEL NO. FOR ORDERING
<b>MP-222K</b> Step 1	+ <b>WA1</b> Step 2	= <b>MP-222KWA1</b>



Michigan Pneumatic Model MP-33W

## Wood Borer - Reversible

Designed for heavy-duty woodworking. Preferred for wood boring as the operator can easily control the power and speed by the throttle. Powerful, lightweight and easy to handle. Ideal for all types of wood boring, construction work, railroads, shipyards and wharf and pier construction. **Uses Ingersoll-Rand 33W wood borer parts.**

Capacity .....	2"	Length .....	17-5/8"
Free Speed .....	800 rpm	Weight .....	28.75 lbs.
Morse Taper .....	#2	Air Inlet Thread .....	1/2"
Maximum HP .....	3.00	Spindle Offset .....	1-7/8"

# Heavy-Duty Corner Drills



22-82232-5600 Ratchet Wrench

## Michigan Pneumatic Model MP-L-257

### Corner Drill - Non-Reversible

Compact, rugged, powerful design for heavy-duty use in cramped areas. Features positive starting control and sensitive speed variation. Will handle various drilling, reaming and tapping applications. Ideal for assembly plants, refineries and railroad shops. **Other models available with #4 M.T. Uses Thor L-257 corner drill parts. Includes ratchet wrench.**

Capacity.....	29/32" Drilling	Height of Spindle.....	5-7/8"
Free Speed.....	320 rpm	Length.....	19-1/2"
Morse Taper.....	#2	Weight.....	14.125 lbs.
Maximum HP.....	1.40	Spindle Offset.....	1-1/4"



C018072 Ratchet Wrench

## Michigan Pneumatic Model MP-323-3

### Corner Drill - Non-Reversible

Designed for heavy-duty use in cramped areas. Features extra heavy-duty grease packed gearing, hardened ground motor liners, a teasing throttle, feed screws and a governor controlled motor. **Includes ratchet wrench.**

Capacity.....	1" Drilling	Height of Spindle.....	8-1/2"
Free Speed.....	175 rpm	Length.....	26-1/8"
Morse Taper.....	#3	Weight.....	21.5 lbs.
Maximum HP.....	1.50	Spindle Offset.....	1-7/16"



R30-48 Ratchet Wrench

## Michigan Pneumatic Model MP-30

### Corner Drill - Non-Reversible

Strong, powerful close quarters drill built to withstand heavy-duty drilling, reaming and tapping where space is limited. Particularly useful in machine shops, power plants and railroad shops. **Model MP-40 also available with #4 M.T. Uses Ingersoll-Rand 30 corner drill parts. Includes ratchet wrench.**

Capacity.....	1-1/4" Drilling	Height of Spindle.....	8-3/4"
Free Speed.....	185 rpm	Length.....	25-1/4"
Morse Taper.....	#3	Weight.....	33 lbs.
Maximum HP.....	2.80	Spindle Offset.....	1-3/8"



## Michigan Pneumatic Model MP-2-1801-0030

### Corner Drill - Non-Reversible

Applications include heavy-duty drilling, reaming and tapping for railroad cars, refineries, shipyards, structural steel fabrication and wood product industries. Features small side-to-side distance for working in tight spaces, self-closing roll throttle, feed screw and built-in motor oiler.

Capacity.....	1-1/4" Drilling	Height of Spindle.....	7.5"
Load Speed.....	260 rpm	Length.....	22-1/2"
Morse Taper.....	#3	Weight.....	25 lbs.
Maximum HP.....	2.60	Spindle Offset.....	1.4"



## Michigan Pneumatic Model MP-2-2104-0030

### Corner Drill - Reversible

Applications include heavy-duty drilling, reaming and tapping for railroad cars, refineries, shipyards, structural steel fabrication and wood product industries. Features small side-to-side distance for working in tight spaces, self-closing roll throttle, feed screw and built-in motor oiler.

Capacity.....	2-1/8" Drilling	Height of Spindle.....	10"
Load Speed.....	180 rpm	Length.....	23.8"
Morse Taper.....	#4	Weight.....	37 lbs.
Maximum HP.....	3.00	Spindle Offset.....	1.6"

# Jacobs® Drill Chucks



## Jacobs® Multi-Craft® Duty Chucks



Jacobs Model	MPT Model	Capacity (min. - max.)	Threaded Mount	Uses Key
SM1G61-T1	SM1G61-T1	0.028 - 0.250"	3/8"-24	KG1
DC4G61-T1	DC4G61-T1	0.063 - 0.375"	3/8"-24	KG1
DC4G61-T2	DC4G61-T2			
SM4G61-T1	SM4G61-T1			
SM4G61-T2	SM4G61-T2			
032116C	SM8K61-T1	0.078 - 0.500"	3/8"-24	KK
032053C	SM8K64-T1		1/2"-20	

### Thread Mounted Light-Duty Industrial Model

Jacobs Model	MPT Model	Capacity (min. - max.)	Threaded Mount	Uses Key
22BA-3/8	22BA-0.375	0.063 - 0.375"	3/8"-24	KK
22BA-1/2	22BA-0.500		1/2"-20	
24BA-3/8	24BA-0.375	0.063 - 0.500"	3/8"-24	KK
26BA-1/2	26BA-0.500		1/2"-20	

## Jacobs® Plain Bearing Drill Chucks

### Thread Mounted Medium-Duty Model

Jacobs Model	MPT Model	Capacity (min. - max.)	Threaded Mount	Uses Key
0B-5/16	0B-0.312	0.0135 - 0.156"	5/16"-24	K0
1BA-3/8	1BA-0.375	0.040 - 0.250"	3/8"-24	K1
2BA-3/8	2BA-0.375	0.040 - 0.375"	3/8"-24	K2
31BA-3/8	31BA-0.375	0.063 - 0.375"	3/8"-24	K30
41BA-3/8	41BA-0.375	0.040 - 0.375"	3/8"-24	K30
41BA-3/8S†	41BA-0.375S†		3/8"-24	
41BA-1/2	41BA-0.500		1/2"-20	
33BA-3/8	33BA-0.375	0.078 - 0.500"	3/8"-24	K32
33BA-1/2	33BA-0.500		1/2"-20	
33BA-5/8	33BA-0.625		5/8"-16	

† Smooth Sleeve

### Thread Mounted Heavy-Duty Model

Jacobs Model	MPT Model	Capacity (min. - max.)	Threaded Mount	Uses Key
7BA-3/8	7BA-0.375	0.040 - 0.250"	3/8"-24	K7
32BA-1/2	32BA-0.500		1/2"-20	
34B-5/8	34B-0.625	0 - 0.500"	5/8"-16	K3
34B-45/64	34B-0.703		45/64"-16	
3B-5/8	3B-0.625	0.125 - 0.625"	5/8"-16	K3
3B-45/64	3B-0.703		45/64"-16	
35B-1/2	35B-0.500	0.156 - 0.625"	1/2"-20	K3
36B-5/8	36B-0.625		5/8"-16	
36B-3/4	36B-0.750		3/4"-16	
36B-45/64	36B-0.703		45/64"-16	

## Jacobs® Ball Bearing Super-Duty Chucks

Super ball bearing chucks are the world's most accurate chucks designed for extra heavy-duty drilling. Ideal for close tolerance production drilling on precision equipment.

Jacobs Model	MPT Model	Capacity (min. - max.)	Taper Mount	Uses Key
8-1/2N	8-0.500N	0.040 - 0.250"	2JTS	K30
11N	11N	0.040 - 0.375"	2JT	K32
14N	14N	0.040 - 0.500"	3JT	K3
16N	16N	0.125 - 0.625"	3JT	K4
18N	18N	0.125 - 0.750"	4JT	K4
20N	20N	0.375 - 1.000"	5JT	K5



## Jacobs® HAND-TITE® Keyless Chuck



Jacobs Model	MPT Model	Capacity (min. - max.)	Threaded Mount	Sleeve Type
31451	31451	0.032 - 0.375"	3/8"-24	2 pc
31708-3/8	31708-ASM			
31967	31967			
31993	31993			
31708	31708	0.032 - 0.375"	2JT	2 pc
32000	32000		1/2"-20	1 pc
31731-3/8	31731-ASM	0.062 - 0.500"	3/8"-24	1 pc
31791	31791			2 pc
32161-3/8	32161-ASM			2 pc
32540	32540			2 pc
31403	31403	0.062 - 0.500"	1/2"-20	2 pc
31731	31731			1 pc
32161	32161			2 pc



### Taper Mounted Medium-Duty Model

Jacobs Model	MPT Model	Capacity (min. - max.)	Taper Mount	Uses Key
0	0	0.0135 - 0.156"	0JT	K0
1A	1A	0.040 - 0.250"	1JT	K1
2A	2A	0.040 - 0.375"	2JT	K2
31-01	31-01		1JT	K30
31-02	31-02		2JT	K30
33	33	0.078 - 0.500"	33JT	K32
33KD **	33KD			

### Taper Mounted Heavy-Duty Model

Jacobs Model	MPT Model	Capacity (min. - max.)	Taper Mount	Uses Key
34-02	34-02	0.040 - 0.500"	2JT	K3
34-06	34-06		6JT	K3
34-33	34-33		33JT	K3
34-33C *	34-33C		33JT	K3C
3A	3A	0.125 - 0.625"	3JT	K3
3KD **	3KD			
3PD ***	3PD			
36	36	0.180 - 0.800"	3JT	K4
36KD **	36KD			
36PD ***	36PD			

\* Equipped with locking collar 1-1/16"-20 thread.

\*\* Equipped with positive drive slot.

\*\*\* Equipped with pin-type positive drive.

## Screwdriver Bit Adapters - Quick Change



Model No.	Shank Size	Threaded Mount
QC-50	1/4" hex	3/8"-24
QC-51	7/16" hex	



## Magnetic Drill

The MDM-40 features a compact 13" height for drilling in tight spaces and automatic lubrication. A 4-speed gearbox and automatic lubrication are standard on the ECO-80AK. **Other magnetic drills are available in either air or electric versions. See below for annular cutters.**

Model	MDM-40	ECO-80AK
Cutter Capacity	1-1/2"	3-3/16"
Twist Drill Capacity	-	1-1/4"
No Load Speed	440 rpm	100/175/245/385 rpm
Arbor Bore	3/4"	3/4"
Stroke	4-3/8"	10"
Motor Power	9.5 amp/110V	15 amp/110V
Magnetic Force (1" plate)	2640 lbs.	7040 lbs.
Magnet Base Size	6-1/2" L x 3-1/4" W	9" L x 4-3/8" W
Dimensions	13" H x 9-1/2" L x 7" W	19-1/2" H x 13-3/8" L x 7-1/2"
Weight	24 lbs.	57 lbs.

## Annular Cutters



Armor-Plated Unibroach™ Cutters are for use with Hougén, Jancy and other magnetic drilling machines with 3/4" arbor collets. More cutting teeth reduces the individual tooth loading, which extends tool life before resharpening and makes for easier, more efficient cutting of tough materials.

Hole Diameter	Decimal Equivalent	Armor-Plated Titanium Aluminum Nitride (coated TiAlN)		
		For 1" Thick Materials	For 2" Thick Materials	For 3" Thick Materials
		Model No.	Model No.	Model No.
7/16"	0.4375"	81114T	81214T	
1/2"	0.5000"	81116T	81216T	
9/16"	0.5625"	81118T	81218T	-
5/8"	0.6250"	81120T	81220T	
11/16"	0.6875"	81122T	81222T	
3/4"	0.7500"	81124T	81224T	81324T
13/16"	0.8125"	81126T	81226T	81326T
7/8"	0.8750"	81128T	81228T	81328T
15/16"	0.9375"	81130T	81230T	81330T
1"	1.0000"	81132T	81232T	81332T
1-1/16"	1.0625"	81134T	81234T	81334T
1-1/8"	1.1250"	81136T	81236T	81336T
1-3/16"	1.1875"	81138T	81238T	81338T
1-1/4"	1.2500"	81140T	81240T	81340T
1-5/16"	1.3125"	81142T	81242T	81342T
1-3/8"	1.3750"	81144T	81244T	81344T
1-7/16"	1.4375"	81146T	81246T	81346T
1-1/2"	1.5000"	81148T	81248T	81348T
1-9/16"	1.5625"	81150T	81250T	81350T
1-5/8"	1.6250"	81152T	81252T	81352T
1-11/16"	1.6875"	81154T	81254T	81354T
1-3/4"	1.7500"	81156T	81256T	81356T
1-13/16"	1.8125"	81158T	81258T	81358T
1-7/8"	1.8750"	81160T	81260T	81360T
1-15/16"	1.9375"	81162T	81262T	81362T
2"	2.0000"	81164T	81264T	81364T
2-1/16"	2.0625"	81166T	81266T	81366T

## Pilots, Arbors & Countersinks

Model No.	Description
73102	Pilot, 1" depth cutter
73202	Pilot, 2" depth cutter
83302	Pilot, 3" depth cutter

Model No.	Description
73902	No. 2 Morse Taper Arbor
73903	No. 3 Morse Taper Arbor
73904	No. 4 Morse Taper Arbor
73910	Countersink, up to 2" hole

# Disc Sanders



**NPK®**



NSG-50A

NSG-100

Nippon Pneumatic **Model NSG-50A**  
**Model NSG-100**

## High-Speed Sander

Compact, perfectly balanced sanders for fine detail applications.

Model	NSG-50A	NSG-100
Capacity	2-1/4"	4"
Free Speed	15000 rpm	13000 rpm
Length	6-3/8"	6-3/16"
Weight	1.5 lbs.	2.0 lbs.
Air Inlet Thread	1/4"	1/4"
Avg. Air Consumption	9.2 cfm	14.1 cfm



Michigan Pneumatic **Model MP-2000X-F**

## High-Speed Sander

Lightweight tool is perfect for finishing flat or contoured surfaces, touch-up, feather-edging and production sanding. Rugged construction for years of carefree service. **Equipped with 3", 4-1/2", 5-1/2" fiber pads.**

**5403** 3" Fiber Pad **5404** 4-1/2" Fiber Pad  
**5405P** 5-1/2" Fiber Pad **110010** Disc Nut

Capacity .....	5"	Weight .....	1.75 lbs.
Free Speed .....	20000 rpm	Air Inlet Thread .....	1/4"
Length .....	5"	Avg. Air Consumption .....	4 cfm



Michigan Pneumatic **Model MP-727-ST**

## High-Speed Sander

Designed for finishing flat or contoured surfaces. Ideal for touch-up, feather-edging and production sanding.

**822028** 3" Fiber Pad  
**822029** 4-1/2" Fiber Pad  
**822030** 5-1/2" Fiber Pad  
**110010** Disc Nut

Capacity .....	5"	Weight .....	2.25 lbs.
Free Speed .....	18000 rpm	Air Inlet Thread .....	1/4"
Length .....	7-1/2"	Avg. Air Consumption .....	4 cfm



Michigan Pneumatic **Model MP-3814-DD**

## High-Speed Sander

See-through sander used in automotive repair shops when better visibility is required. Backing pad doubles as cooling system for sanding disc. Lightweight to reduce operator fatigue.

**ACC-3812P** Backing Pad  
**ACC-3812A** 36 Grit Sand Paper  
**ACC-3812B** 60 Grit Sand Paper

Capacity .....	5"	Weight .....	3.65 lbs.
Free Speed .....	6000 rpm	Air Inlet Thread .....	1/4"
Length .....	8-1/4"	Avg. Air Consumption .....	5 cfm



National Detroit **Model DCQ**

## Disc Action Sander

Designed to speed production on light grinding and sanding to remove heavy grinder swirls. **Lower noise level, OSHA approved.** Additional 4" and 5" pads also available. Please specify pad size.

**3021FP** 4" Felt Pad  
**3055** 5" Felt Pad

Capacity .....	4" or 5"	Weight .....	3.625 lbs.
Free Speed .....	12000 rpm	Air Inlet Thread .....	1/4"
Length .....	8"	Avg. Air Consumption .....	4 cfm



## Michigan Pneumatic Model MP-DA6-ST

### Random Orbital Sander

Ball bearing construction, balanced counterweights and a built-in speed regulator make this sander ideal for metal preparation.

**SP-005** 6" Vinyl Pad  
**B-6201ZZ** Pad Bearing

Capacity.....	6"	Weight.....	4 lbs.
Free Speed.....	10000 rpm	Air Inlet Thread.....	1/4"
Length.....	8-3/4"	Avg. Air Consumption.....	5 cfm



## National Detroit Model DA

### Dual Action Sander

Proven orbital action sander provides a smoother, scratch-free finish as the abrasives travel in a non-repeating path, reducing heat generation. Lightweight with built-in regulator. **Additional 3", 5" and 6" pads also available. Please specify pad size.**

**4062-3** 3" Vinyl Pad      **4062-5** 5" Vinyl Pad  
**4062-6** 6" Vinyl Pad

Capacity.....	3", 5" or 6"	Weight.....	4.125 lbs.
Free Speed.....	6000 rpm	Air Inlet Thread.....	1/4"
Length.....	8-1/4"	Avg. Air Consumption.....	11 cfm



## National Detroit Model DA-DE

### Dual Action Sander

Proven orbital action sander provides a smoother, scratch-free finish as the abrasives travel in a non-repeating path, reducing heat generation. Lightweight with built-in regulator. **Additional 5" and 6" pads also available. Please specify pad size.**

**4162-5** 5" Vinyl Pad with Dust Extraction Holes  
**4162-6** 6" Vinyl Pad with Dust Extraction Holes

Capacity.....	5" or 6"	Weight.....	4.125 lbs.
Free Speed.....	6000 rpm	Air Inlet Thread.....	1/4"
Length.....	8-1/4"	Avg. Air Consumption.....	11 cfm



## National Detroit Model DAQ

### Dual Action Sander

Proven orbital action sander provides a smoother, scratch-free finish as the abrasives travel in a non-repeating path, reducing heat generation. Lightweight with built-in regulator. **Lower noise level, OSHA approved. Additional 3", 5" and 6" pads also available. Please specify pad size.**

**4062-3** 3" Vinyl Pad      **4062-5** 5" Vinyl Pad  
**4062-6** 6" Vinyl Pad

Capacity.....	3", 5" or 6"	Weight.....	4.125 lbs.
Free Speed.....	6000 rpm	Air Inlet Thread.....	1/4"
Length.....	8-1/4"	Avg. Air Consumption.....	11 cf



## National Detroit Model EZQ

### Dual Action Sander

Combines dual action sanding with features allowing the pad to operate flat on work surfaces. Exceptionally smooth operation for controlled stock removal. **Model EZQ-6DE with dust extraction system available. Additional 3", 4", 5" and 6" pads also available. Please specify pad size.**

**4062-3** 3" Vinyl Pad      **4862-5** 5" Vinyl Pad  
**4062-4** 4" Vinyl Pad      **4862-6** 6" Vinyl Pad

Capacity.....	3", 4", 5" or 6"	Weight.....	3.6 lbs.
Free Speed.....	10000 rpm	Air Inlet Thread.....	1/4"
Length.....	9-3/8"	Avg. Air Consumption.....	11 cfm

# Random Orbital Palm Sanders



## Michigan Pneumatic Model MP-844-ST

### Palm Sander - with Vacuum Pickup

Palm type sander features dust-free sanding for a cleaner work environment. Orbital action provides a smoother, finer finish for better results. Powerful, compact, lightweight, with low vibration action for operator comfort and higher productivity. Built-in adjustable speed regulator for versatility.

**60334-6** 6" Vinyl Pad with Dust Extraction Holes

Capacity .....	6"	Weight .....	3 lbs.
Free Speed .....	10000 rpm	Air Inlet Thread .....	1/4"
Height .....	4"	Avg. Air Consumption .....	6 cfm



## Michigan Pneumatic Model MP-3368-DD

### Palm Sander

Powerful palm sander designed to reduce heat generation on application material. Lightweight with built-in regulator.

**4862-6** 6" Vinyl Pad

Capacity .....	6"	Weight .....	1.56 lbs.
Free Speed .....	12000 rpm	Air Inlet Thread .....	1/4"
Height .....	3-3/8"	Avg. Air Consumption .....	11 cfm



## National Detroit Model PGU-DE

### Palm Sander - with Vacuum Pickup

Lightweight, powerful, quiet and rugged. Features integral dust extraction system, proven bearing design and interchangeable pads to fit any sanding application. **Model PGU without dust extraction system available.**

**Additional pads available. Please specify pad size.**

**4862-5** 5" Vinyl Pad      **4162-5** 5" Vinyl Pad w/Dust Extraction Holes  
**4862-6** 6" Vinyl Pad      **4162-6** 6" Vinyl Pad w/Dust Extraction Holes

Capacity .....	5" or 6"	Weight .....	2.1 lbs.
Free Speed .....	12000 rpm	Air Inlet Thread .....	1/4"
Height .....	4-1/2"	Avg. Air Consumption .....	11 cfm



## National Detroit Model PGSS

### Palm Sander

Random orbital sander designed for fine finish work. Ideal for sanding clear coat and lacquers. **Additional 3", 5" and 6" pads also available. Please specify pad size. Model PGSS-DE with dust extraction system available.**

**4862-3** 3" Vinyl Pad      **4162-5** 5" Vinyl Pad w/Dust Extraction Holes  
**4862-5** 5" Vinyl Pad      **4162-6** 6" Vinyl Pad w/Dust Extraction Holes  
**4862-6** 6" Vinyl Pad

Capacity .....	3", 5" or 6"	Weight .....	2.1 lbs.
Free Speed .....	12000 rpm	Air Inlet Thread .....	1/4"
Height .....	4-3/4"	Avg. Air Consumption .....	11 cfm



## National Detroit Model PG-8

### Palm Sander

One hand sander allows for better control on flat surfaces. Reduces "scallop" on wood and fiberglass due to uneven pressure applied to the tool. Heavy-duty construction for durability. **Model PG-8DE with dust extraction system available.**

**4180** 8" Vinyl Pad w/Dust Extraction Holes

Capacity .....	8"	Weight .....	3.1 lbs.
Free Speed .....	8000 rpm	Air Inlet Thread .....	1/4"
Height .....	5"	Avg. Air Consumption .....	12 cfm





## National Detroit Model 9600

### Geared Sander

Capable of rough knock-down or fine feather edging. The driven gear “floats” on a cushioned mounting, providing smoother control with the power of a gear driven design. **Model 9600DE with dust extraction system available. Additional 5" and 6" pads also available. Please specify pad size.**

<b>9450-5</b>	5" Vinyl Pad	<b>9677-5</b>	5" Hook & Loop Pad with DE Holes
<b>9460-6</b>	6" Vinyl Pad	<b>9677-6</b>	6" Hook & Loop Pad with DE Holes

Capacity .....	5" or 6"	Weight .....	4.5 lbs.
Free Speed .....	9000 rpm	Air Inlet Thread .....	1/4"
Abrasive Area .....	28 sq. in.	Avg. Air Consumption .....	14 cfm



## National Detroit Model 9900

### Geared Buffer/Sander

Lightweight buffer/sander removes paint up to 3.5 times faster than other sanders. T-handle motor cover and soft grip handle provide ergonomic comfort.

<b>9591</b>	6" Buffering Pad
<b>9980</b>	6" Vinyl Pad

Capacity .....	6" Buffer/6" Pad	Weight .....	4.7 lbs.
Free Speed .....	9000 rpm	Air Inlet Thread .....	1/4"
Abrasive Area .....	28 sq. in.	Avg. Air Consumption .....	14 cfm



## National Detroit Model 9900DE

### Geared Buffer/Sander

Lightweight buffer/sander removes paint up to 3.5 times faster than other sanders. T-handle motor cover and soft grip handle provide ergonomic comfort.

<b>9591</b>	6" Buffering Pad
<b>9980</b>	6" Vinyl Pad

Capacity .....	6" Buffer/6" Pad	Weight .....	5 lbs.
Free Speed .....	9000 rpm	Air Inlet Thread .....	1/4"
Abrasive Area .....	28 sq. in.	Avg. Air Consumption .....	14 cfm



## National Detroit Model 900

### 8" Geared Sander

Gear driven sander moves with positive rotation and secondary oscillating action. Fast stock removal prevents normal grinder scratch patterns. Designed for applications between grinding and finish sanding. Features a built-in regulator.

<b>4080VP</b>	8" Vinyl Pad
---------------	--------------

Capacity .....	8"	Weight .....	4.75 lbs.
Free Speed .....	9000 rpm	Air Inlet Thread .....	1/4"
Abrasive Area .....	50 sq. in.	Avg. Air Consumption .....	14 cfm



## National Detroit Model 900DE

### 8" Geared Sander

Gear driven sander moves with positive rotation and secondary oscillating action. Fast stock removal prevents normal grinder scratch patterns. Designed for applications between grinding and finish sanding. Features a built-in regulator.

<b>4088</b>	8" Vinyl Pad with Dust Extraction Holes
-------------	---

Capacity .....	8"	Weight .....	5 lbs.
Free Speed .....	9000 rpm	Air Inlet Thread .....	1/4"
Abrasive Area .....	50 sq. in.	Avg. Air Consumption .....	14 cfm



## Michigan Pneumatic Model MP-1265-ST

### Vertical Sander

Features extra-heavy gearing for heavy-duty operation. Compact and lightweight design for hard to reach spots and reduced operator fatigue. Adjustable speed control allows delicate feather-edging to full speed sanding.

**829040** Pad Nut **731247** Pad

Capacity.....	7"	Height.....	7-1/2"
Free Speed .....	4000 rpm	Weight.....	4.5 lbs.
Spindle Thread .....	5/8"-11	Air Inlet Thread .....	1/4"
Maximum HP .....	1.00	Avg. Air Consumption .....	9 cfm



## Michigan Pneumatic Model MP-B332

### Vertical Sander - with Rubber Pad

Heavy-duty tool for steady production. May be used for disc sanding, cup wire brushing and cup wheel grinding. Ideal for cutting high spots and smoothing flat surfaces. **Please specify lever or butterfly throttle. Model MP-B332WW with wire wheel available.**

**R700-R** 7" Rubber Backing Pad

Capacity.....	7" Pad	Length.....	8-3/4"
Free Speed .....	6000 rpm	Height.....	7-5/8"
Spindle Thread .....	5/8"-11	Weight.....	7.3 lbs.
Maximum HP .....	1.20	Air Inlet Thread .....	3/8"



## National Detroit Model XLB

### Buffer/Sander

Excels at both sanding and buffing. Double row head bearing design for long life. Features foam grip and T-handle for operator comfort. **Additional 3", 5" and 6" pads also available. Please specify pad size.**

**4862-3** 3" Vinyl Pad **4862-5** 5" Vinyl Pad  
**4862-6** 6" Vinyl Pad

Capacity.....	3", 5" or 6"	Weight.....	3.3 lbs.
Free Speed .....	10000 rpm	Air Inlet Thread .....	1/4"
Abrasive Area .....	28 sq. in.	Avg. Air Consumption .....	13 cfm



## Michigan Pneumatic Model MP-6902K7-ST

### Stripping Tool Kit

Versatile tool used in the automotive industry. Excellent for cleaning welds, adhesives and rust off work surface.

<b>SM-6902</b>	Utility In-Line Driver	<b>0511</b>	11mm Brush (Fine)
<b>SA-6902RW</b>	Rubber Eraser	<b>0711</b>	11mm Brush (Coarse)
<b>SA-6902WH</b>	Adaptor (11mm)	<b>0523</b>	23mm Brush (Fine)
<b>SA-6902RH</b>	Adaptor (23mm)	<b>0723</b>	23mm Brush (Coarse)

#### MP-6902K7-ST Accessories (included)



Free Speed .....	3500 rpm	Rec'd Hose Size .....	3/8"
Length.....	12"	Air Inlet Thread .....	1/4"
Weight.....	3.2 lbs.	Avg. Air Consumption .....	4 cfm

# Belt Sanders



TA99155 Idler Pulley Assembly

## Michigan Pneumatic Model MP-10A-ST Belt Sander

Small, lightweight belt sander, ideal for all materials, eliminates filing. Goes deep into hard to reach places, corners and spherical surfaces.

**61122** 40 Grit Belt      **61125** 80 Grit Belt      **61127** 120 Grit Belt  
**61124** 60 Grit Belt      **61126** 100 Grit Belt

Belt Size.....	3/8" x 13"	Length (max.).....	10-7/16"
Free Speed.....	16000 rpm	Weight.....	1.7 lbs.
Height.....	2"	Air Inlet Thread.....	1/4"
Maximum HP.....	0.4	Avg. Air Consumption.....	14 cfm



TA90514 Idler Pulley Assembly

## Michigan Pneumatic Model MP-20S-ST Belt Sander

Small, lightweight air sander will sand all jobs, all materials with amazing speed and ease. No surface escapes its all-surface capability. Levels and contours, even in corners. Adjustable handle rotates 360°. Change belts in seconds.

**60129** 40 Grit Belt      **60132** 80 Grit Belt      **60134** 120 Grit Belt  
**60131** 60 Grit Belt      **60133** 100 Grit Belt

Belt Size.....	3/4" x 20-1/2"	Length (max.).....	18-1/2"
Free Speed.....	16000 rpm	Weight.....	3.1 lbs.
Height.....	2-23/64"	Air Inlet Thread.....	1/4"
Maximum HP.....	0.6	Avg. Air Consumption.....	18 cfm



TA91522 Idler Pulley Assembly

## Michigan Pneumatic Model MP-30S-ST Belt Sander

The most efficient adjustable belt sander ever developed, with a new, silent motor. Sands all materials with speed and ease. Levels and contours, even in corners. Maximum efficiency without operator fatigue.

**TP04084-0** 60 Grit Belt      **TP04086-0** 100 Grit Belt  
**TP04085-0** 80 Grit Belt

Belt Size.....	1-3/16" x 21"	Length (max.).....	19-1/4"
Free Speed.....	12000 rpm	Weight.....	4.9 lbs.
Height.....	4-1/8"	Air Inlet Thread.....	3/8"
Maximum HP.....	0.7	Avg. Air Consumption.....	24 cfm



## Michigan Pneumatic Model MP-6201K-DD Belt Sander Kit

Lightweight belt sander levels and contours most surfaces, even in corners. Includes 6 interchangeable contact arms and assorted sanding belts with plastic case.

Belt Size.....	1/4" ~ 1" x 18"	Length (max.).....	15.4"
Free Speed.....	18000 rpm	Weight.....	2.9 lbs.
Height.....	2-11/32"	Air Inlet Thread.....	1/4"
Maximum HP.....	0.6	Avg. Air Consumption.....	16 cfm



## Michigan Pneumatic Model MP-MVM3562 Belt Sander

Comfortable and well balanced. Features easy fingertip tracking and belt changing. Excellent power and speed for any belt sanding operation. Ideal for working around water and in heavy dust environments. Uses standard 3" x 21" belts, 100 grit or finer. Includes dust extraction bag.

Belt Size.....	3" x 21"	Length (max.).....	13"
Free Speed.....	2600 rpm	Weight.....	9.25 lbs.
Height.....	8"	Air Inlet Thread.....	1/4"
Maximum HP.....	1.25	Avg. Air Consumption.....	29 cfm

# Belt & Pad Sanders



TA99155 Idler Pulley Assembly

## Nitto Kohki Model B-10B

### Belt Sander

Small, lightweight belt sander, ideal for all materials, eliminates filing. Goes deep into hard to reach places, corners and spherical surfaces.

61122 40 Grit Belt    61125 80 Grit Belt    61127 120 Grit Belt  
61124 60 Grit Belt    61126 100 Grit Belt

Belt Size .....	3/8" x 13"	Length (max.) .....	10-7/16"
Free Speed .....	16000 rpm	Weight .....	1.7 lbs.
Height .....	2"	Air Inlet Thread .....	1/4"
Maximum HP .....	0.4	Avg. Air Consumption .....	14 cfm



TA90514 Idler Pulley Assembly

## Nitto Kohki Model B-20C

### Belt Sander

Small, lightweight air sander will sand all jobs, all materials with amazing speed and ease. No surface escapes its all-surface capability. Levels and contours, even in corners. Adjustable handle rotates 360°. Change belts in seconds.

60129 40 Grit Belt    60132 80 Grit Belt    60134 120 Grit Belt  
60131 60 Grit Belt    60133 100 Grit Belt

Belt Size .....	3/4" x 20-1/2"	Length (max.) .....	18-1/2"
Free Speed .....	16000 rpm	Weight .....	3.1 lbs.
Height .....	2-23/64"	Air Inlet Thread .....	1/4"
Maximum HP .....	0.6	Avg. Air Consumption .....	18 cfm



TA91522 Idler Pulley Assembly

## Nitto Kohki Model B-30A

### Belt Sander

The most efficient adjustable belt sander ever developed, with a new, silent motor. Sands all materials with speed and ease. Levels and contours, even in corners. Maximum efficiency without operator fatigue.

TP04084-0 60 Grit Belt    TP04086-0 100 Grit Belt  
TP04085-0 80 Grit Belt

Belt Size .....	1-3/16" x 21"	Length (max.) .....	19-1/4"
Free Speed .....	12000 rpm	Weight .....	4.9 lbs.
Height .....	4-1/8"	Air Inlet Thread .....	1/4"
Maximum HP .....	0.7	Avg. Air Consumption .....	24 cfm



## Nitto Kohki Model FS-50A

### Free Sander

Compact and lightweight with low air consumption for big jobs and tight spots. Rugged construction for continuous operation. Perfect for surface finishing wood and thin plates or de-burring plastic. Features quick change paper clips for easy mounting. **Low vibration motor reduces operator fatigue.**

Capacity .....	2-3/4" x 4-1/2"	Weight .....	1.1 lbs.
Free Speed .....	15000 rpm	Air Inlet Thread .....	1/4"
Abrasive Area .....	12.5 sq. in.	Avg. Air Consumption .....	4.9 cfm



## Nitto Kohki Model FS-100C

### Free Sander

Compact and lightweight with low air consumption for big jobs and tight spots. Rugged construction for continuous operation. Perfect for surface finishing wood and thin plates or de-burring plastic. Features quick change paper clips for easy mounting. **Low vibration motor reduces operator fatigue.**

Capacity .....	4-1/2" x 5-1/2"	Weight .....	1.1 lbs.
Free Speed .....	20000 rpm	Air Inlet Thread .....	1/4"
Abrasive Area .....	24 sq. in.	Avg. Air Consumption .....	7.1 cfm



## Michigan Pneumatic Model MP-865-ST

### Orbital Action Sander/Jitterbug

Heavy-duty sander is ideal for body and paint shops. 3/16" orbital stroke provides a swirl-free finish. Powerful, fully enclosed motor. Balanced for vibration-free performance. Ideal for wet and dry sanding.

Capacity .....	3-2/3" x 9"	Weight .....	4.5 lbs.
Free Speed .....	6500 rpm	Air Inlet Thread .....	1/4"
Abrasive Area .....	25 sq. in.	Avg. Air Consumption .....	7 cfm



Model 400

## National Detroit Model 150 & Model 400

### Orbital Action Sanders

Powerful, versatile, dependable, quiet sanders work on the principle of circular movement, with a 3/16" orbital stroke. Ideal for metal or wood finishing jobs. Great for hard to reach areas.

**113** Neoprene Pad (150)                      **DP1084** Neoprene Pad (400)

Model	150	400
Capacity	3" x 8"	3-2/3" x 9"
Free Speed	4000 - 6000 rpm	4000 - 6000 rpm
Abrasive Area	18 sq. in.	25 sq. in.
Weight	3.875	4.5
Air Inlet Thread	1/4"	1/4"
Avg. Air Consumption	7 cfm	7 cfm



## National Detroit Model 2200

### Orbital Pad Sander

Aggressive, yet controllable sander perfect for today's sanding needs. Non-marring pad and quiet motor round out the features.

**8890RP** Rubber Pad  
**8891RP** Rubber Pad, textured

Capacity .....	2-3/4" x 8"	Weight .....	4.7 lbs.
Free Speed .....	6000 rpm	Air Inlet Thread .....	1/4"
Abrasive Area .....	22 sq. in.	Avg. Air Consumption .....	11 cfm



## National Detroit Model 2200DE

### Orbital Pad Sander - with Vacuum Pickup

Dust extraction version of the 2200 designed to remove contaminants from the work surface. Features a non-marring pad.

**8890RP** Rubber Pad  
**8891RP** Rubber Pad, textured

Capacity .....	2-3/4" x 8"	Weight .....	4.8 lbs.
Free Speed .....	6000 rpm	Air Inlet Thread .....	1/4"
Abrasive Area .....	22 sq. in.	Avg. Air Consumption .....	11 cfm

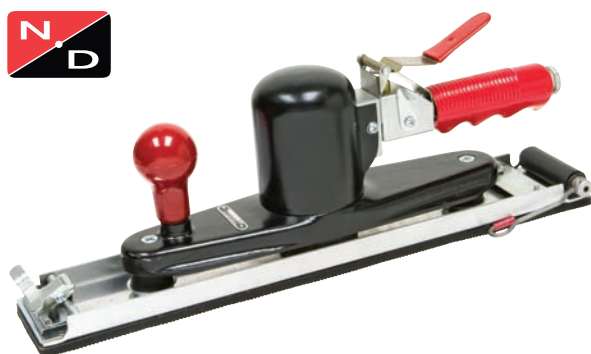

## National Detroit Model FB-8

### Orbital Pad Sander

Rapid material knock-down achieved using positive thrust support from the motor. Superb counter-balancing insures minimal vibration reducing operator fatigue.

**4191RP** Rubber Pad

Capacity .....	2-3/4" x 16"	Weight .....	5.5 lbs.
Free Speed .....	6000 rpm	Air Inlet Thread .....	1/4"
Abrasive Area .....	44 sq. in.	Avg. Air Consumption .....	11 cfm



## National Detroit Model 600 Straight-Line Sander

Single pad sander will boost production and provide a better finish. Rapid stock removal with built-in water spray attachment. Paper change is simple and quick. Ideal for wet sanding. **OSHA approved.**

**6150** Molded Rubber Pad

Capacity .....	3-2/3" x 9"	Weight .....	5.375 lbs.
Free Speed .....	3200 rpm	Air Inlet Thread .....	1/8"
Abrasive Area .....	25 sq. in.	Avg. Air Consumption .....	7 cfm



## National Detroit Model 300 Two-Pad Straight-Line Sander

Double pad sander will boost production and provide the best finish possible. Rapid stock removal with built-in water spray attachment. Ideal for wet sanding. Six different pads available, please specify. Meets OSHA noise level standards. **Price includes shoes and pads.**

**DP1086** Rubber Pad

Capacity .....	3-2/3" x 9"	Weight .....	6 lbs.
Free Speed .....	2250 rpm	Air Inlet Thread .....	1/4"
Abrasive Area .....	50 sq. in.	Avg. Air Consumption .....	7 cfm



## National Detroit Model 1100 Straight-Line Sander

Compact straight-line sander designed for fine finish work. Polymer pad shoe won't damage work surface.

**8890RP** Rubber Pad  
**8891RP** Rubber Pad, textured

Capacity .....	2-3/4" x 8"	Weight .....	4.75 lbs.
Free Speed .....	6000 rpm	Air Inlet Thread .....	1/4"
Abrasive Area .....	22 sq. in.	Avg. Air Consumption .....	11 cfm



## National Detroit Model 1100DE Straight-Line Sander

Straight-line powerhouse with dust extraction system. Features non-marring polymer pad.

**8890RP** Rubber Pad  
**8891RP** Rubber Pad, textured

Capacity .....	2-3/4" x 8"	Weight .....	4.8 lbs.
Free Speed .....	6000 rpm	Air Inlet Thread .....	1/4"
Abrasive Area .....	22 sq. in.	Avg. Air Consumption .....	11 cfm



## Michigan Pneumatic Model MP-0065-ST Straight-Line Sander

The "President" features double acting pistons and a four cylinder driving system. As the dual pistons constantly work in alternating opposition to one another, there is no dead center, providing unparalleled power on the job and fatigue-free operation.

Capacity .....	2-3/4" x 17-1/4"	Weight .....	6.5 lbs.
Free Speed .....	3300 rpm	Air Inlet Thread .....	1/4"
Abrasive Area .....	40 sq. in.	Avg. Air Consumption .....	6 cfm



## Pencil Style Air Grinders with Adjustable Throttle

Newly developed pencil grinders are compact, super lightweight and designed to provide greater operator efficiency. Unusually powerful for the toughest jobs. Will grind all materials with amazing speed and ease. Ideal for metal, plastic, wood and stone works. **Not equipped with carbide burrs as shown. Includes 6 ft. exhaust hose.**

**Perfect for:**

- Finishing metal patterns
- Processing inner and outer surfaces
- Sheet metal working
- Treating after welding
- Finishing precision parts



**MP-SM516**  
Replacement Part  
560021 1/8" Collet



**MP-US3**  
Replacement Part  
US302 1/8" Collet



**MP-US6**  
Replacement Parts  
US602 1/4" Collet  
US602-6mm 6mm Collet

Model No.	Collet Size	Free Speed	Diameter	Length	Weight	Avg. Air Consumption
MP-SM516	1/8"	50000-54000 rpm	0.63"	5.3"	0.24 lbs.	0.78 cfm
MP-US3	1/8"	50000-60000 rpm	0.63"	5.3"	0.24 lbs.	0.78 cfm
MP-US6	1/4"	30000-40000 rpm	0.90"	5.9"	0.60 lbs.	1.10 cfm



## Michigan Pneumatic Model MP-1775-ST Die Grinder - Rear Exhaust

1/4" die grinder features a full bearing support air motor. Equipped with lever throttle for variable speed control. New rear exhaust directs air away from work area.



**C-1073-0.125** 1/8" Collet **52225**  
**C-1073-0.250** 1/4" Collet **52227**  
Collet Nut  
Wrench (2)

Collet Size.....	1/4"	Length.....	5-1/2"
Free Speed.....	25000 rpm	Weight.....	0.88 lbs.
Maximum HP.....	0.25	Air Inlet Thread.....	1/4"
Rec'd Hose Size.....	1/4"	Avg. Air Consumption.....	3 cfm



## Michigan Pneumatic Model MP-210-AT - Front Exhaust Model MP-220-AT - Rear Exhaust

### Die Grinder

Small, lightweight grinder is rugged for automotive and industrial work. Quality motor provides power, accuracy and durability. Front exhaust keeps work area clean. Variable speed control for high speed or high torque.

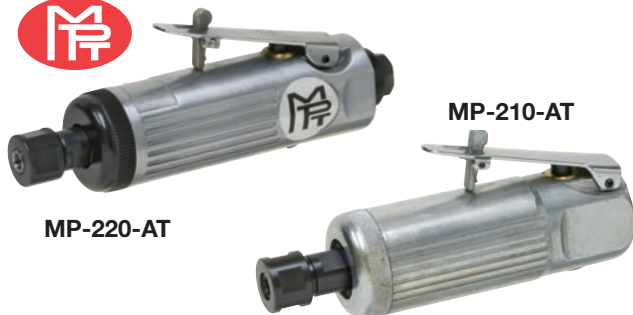

**MP-220-AT**  
**MP-210-AT**  
**C-1073-0.125** 1/8" Collet **220-30**  
**C-1073-0.250** 1/4" Collet **220-32**  
**C-1005N** Collet Nut  
Wrench  
Wrench

Collet Size.....	1/4"	Length.....	5-1/2" (MP-210) & 6-5/8" (MP-220)
Free Speed.....	22000 rpm	Weight.....	1.25 lbs.
Maximum HP.....	0.30	Air Inlet Thread.....	1/4"
Rec'd Hose Size.....	3/8"	Avg. Air Consumption.....	4 cfm

# Angle Die Grinders



## Michigan Pneumatic Model MP-AG21-ST

### Angle Die Grinder - Front Exhaust

Powerful right angle grinder is designed to get into hard to reach areas where straight types are not accessible. Ideal for use with pressure sensitive discs, mounted points and rotary files for automotive body work. Front exhaust design keeps work area clean. Lightweight for easy handling.



2-7/8"

C-1073-0.125  
C-1073-0.250  
52225  
52227

1/8" Collet  
1/4" Collet  
Collet Nut  
Wrench (2)

Collet Size.....	1/4"	Length.....	4-7/8"
Free Speed.....	20000 rpm	Weight.....	1 lb.
Maximum HP.....	0.5	Air Inlet Thread.....	1/4"
Rec'd Hose Size.....	1/4"	Avg. Air Consumption.....	3 cfm



## Michigan Pneumatic Model MP-2775-ST

### Angle Die Grinder - Rear Exhaust

Rear exhaust die grinder features full bearing angle head construction. New rear exhaust directs air away from work area. Ideal for general purpose grinding in hard to reach areas. Uses pressure sensitive discs and mounted points for automotive body work. Equipped with independent power regulator and variable speed control.



2-7/8"

C-1073-0.125  
C-1073-0.250  
52225  
52227

1/8" Collet  
1/4" Collet  
Collet Nut  
Wrench (2)

Collet Size.....	1/4"	Length.....	5-1/2"
Free Speed.....	22000 rpm	Weight.....	1 lb.
Maximum HP.....	0.4	Air Inlet Thread.....	1/4"
Rec'd Hose Size.....	1/4"	Avg. Air Consumption.....	3 cfm



## Nitto Kohki Model MAS-20B

### Angle Sander/Grinder - Side Exhaust

Ultra compact sander/grinder with a built-in silencer. Ideal for sanding and grinding intricate shapes in cramped areas. Adding the 2" support pad, included, allows the use of 1", 1-1/2" and 2" paper discs in a variety of grits. Simple one touch twist lock speeds paper replacement.



2-27/32"

TP10742  
TA98821-0  
TA98822-0  
5542  
5540

Collet Nut  
1" Support Pad  
1-1/2" Support Pad  
2" Support Pad  
3" Support Pad

Collet Size.....	1/4"	Length.....	5"
Free Speed.....	20000 rpm	Weight.....	1.1 lbs.
Maximum HP.....	0.24	Air Inlet Thread.....	1/4"
Rec'd Hose Size.....	1/4"	Avg. Air Consumption.....	14 cfm



## Michigan Pneumatic Model MP-3040-C

### Angle Die Grinder - Side Exhaust

Industrial grinder excellent for die contouring, deburring and blending in hard to reach areas. **Model MP-3040A-C with aluminum motor housing available.**



2-1/2"

G-3327  
G-3858  
GA-3858

Wrench  
Wrench  
Collet Nut

Collet Size.....	1/4"	Length.....	8"
Free Speed.....	13500 rpm	Weight.....	2.75 lbs.
Maximum HP.....	1.00	Air Inlet Thread.....	1/4"
Rec'd Hose Size.....	3/8"	Avg. Air Consumption.....	11.9 cfm



## Michigan Pneumatic Model MP-3040E-C

### Extended Angle Die Grinder - Side Exhaust

Extended grinder used in die shops, shipyards, foundries and fabrication shops. Rugged 1 HP motor. **Model MP-3040AE-C with aluminum motor housing available.**



2-1/2"

G-3327  
G-3858  
GA-3858

Wrench  
Wrench  
Collet Nut

Collet Size.....	1/4"	Length.....	10"
Free Speed.....	13500 rpm	Weight.....	3.20 lbs.
Maximum HP.....	1.00	Air Inlet Thread.....	1/4"
Rec'd Hose Size.....	3/8"	Avg. Air Consumption.....	11.9 cfm





**C-1073-0.125** 1/8" Collet  
**C-1073-0.250** 1/4" Collet  
**C-1005N** Collet Nut  
**220-30** Wrench  
**220-32** Wrench

## Michigan Pneumatic Model MP-1151B-ST

### Die Grinder - Rear Exhaust

Comfort cushioned die grinder perfect for delicate finishing work. Features recessed safety lever throttle and top mounted air regulator. Part of the Quiet Tools family of grinders.

Collet Size.....1/4"	Length.....7-13/32"
Free Speed.....20000 rpm	Weight.....1.50 lbs.
Maximum HP.....0.25	Air Inlet Thread.....1/4"
Rec'd Hose Size.....3/8"	Avg. Air Consumption.....4 cfm



**C-1073-0.125** 1/8" Collet  
**C-1073-0.250** 1/4" Collet  
**52225** Collet Nut  
**52227** Wrench (2)

## Michigan Pneumatic Model MP-2753-ST

### Die Grinder - Rear Exhaust

Silenced, 77dB(A), rear exhaust set this tool apart from the rest. Features top mounted air regulator, cushion grip and recessed safety lever throttle.

Collet Size.....1/4"	Length.....6-1/8"
Free Speed.....25000 rpm	Weight.....1.25 lbs.
Maximum HP.....0.30	Air Inlet Thread.....1/4"
Rec'd Hose Size.....3/8"	Avg. Air Consumption.....4 cfm



**C-1073-0.125** 1/8" Collet  
**C-1073-0.250** 1/4" Collet  
**52225** Collet Nut  
**52227** Wrench (2)

## Michigan Pneumatic Model MP-2754-ST

### Die Grinder - Rear Exhaust

Featuring top mounted air regulator and recessed safety throttle lever design gives our extended grinder a leg up on the competition. Perfect for those hard to reach areas. Includes same silenced exhaust as all of the Quiet Tools family.

Collet Size.....1/4"	Length.....9-7/8"
Free Speed.....25000 rpm	Weight.....1.90 lbs.
Maximum HP.....0.30	Air Inlet Thread.....1/4"
Rec'd Hose Size.....3/8"	Avg. Air Consumption.....4 cfm



3"

**C-1073-0.125** 1/8" Collet  
**C-1073-0.250** 1/4" Collet  
**52225** Collet Nut  
**52227** Wrench (2)

## Michigan Pneumatic Model MP-7252-ST

### Angle Die Grinder - Rear Exhaust

Silenced, 77dB(A), rear exhaust set this tool apart from the rest. Features top mounted air regulator, cushion grip and recessed safety lever throttle.

Collet Size.....1/4"	Length.....6-11/16"
Free Speed.....20000 rpm	Weight.....1.33 lbs.
Maximum HP.....0.30	Air Inlet Thread.....1/4"
Rec'd Hose Size.....3/8"	Avg. Air Consumption.....4 cfm



3-3/8"

**C-1073-0.125** 1/8" Collet  
**C-1073-0.250** 1/4" Collet  
**52225** Collet Nut  
**52227** Wrench (2)

## Michigan Pneumatic Model MP-7255-ST

### Angle Die Grinder - Rear Exhaust

115° degree angle grinder features recessed safety lever throttle cushion grip and top mounted air regulator. Silenced, 77dB(A), rear exhaust to reduce tool noise.

Collet Size.....1/4"	Length.....7-29/32"
Free Speed.....20000 rpm	Weight.....1.40 lbs.
Maximum HP.....0.30	Air Inlet Thread.....1/4"
Rec'd Hose Size.....3/8"	Avg. Air Consumption.....4 cfm



**RG-383**

**15015309** Collet Nut  
**SN-12.7** Wrench  
**SN-13** Wrench



**RG-38ASLW**

**G05010K180** Collet Nut  
**SN-12.7** Wrench  
**SN-15** Wrench



**RG-38CX**

**15015309** Collet Nut  
**SN-12.7** Wrench  
**SN-13** Wrench

Ideal for the precise, delicate finishing required in handling small points and burrs. Features close tolerance-machined, extremely durable motor components for extended use in industrial applications. **Model RG-383 features aluminum motor housing. Model RG-38ASLW features steel motor housing. Model RG-38CX features composite plastic housing.**



Model No.	Collet Size	Free Speed	Exhaust	Diameter	Length	Weight	Rec'd Hose Size	Air Inlet Thread	Avg. Air Consumption
RG-383	1/4"	22000 rpm	Front	1-1/2"	6-3/4"	1.3 lbs.	3/8"	1/4"	17.6 cfm
RG-38ASLW					6-25/32"	1.5 lbs.			15.9 cfm
RG-38CX					6-3/4"	1.3 lbs.			17.6 cfm



**C-1025-0.125** 1/8" Collet **SN-17.5** Wrench  
**C-1025-0.250** 1/4" Collet **SN-12.7** Wrench  
**GG-43802** Collet Nut

**Michigan Pneumatic Model MP-70000 - Button Throttle Die Grinder - Side Exhaust**

High speed die grinders for rapid metal removal or precise finishing. Versatile for driving carbide burrs or mounted points. Rugged, compact and lightweight for easy handling. Built-in regulator. **Parts are interchangeable with ARO 0-series short grinders.**

Collet Size.....	1/4"	Length.....	6-1/2"
Free Speed .....	18000 rpm	Weight.....	1.4 lbs.
Spindle Thread .....	3/8"-24	Air Inlet Thread .....	1/4"
Maximum HP .....	0.55	Avg. Air Consumption .....	14 cfm



**MP-23000**

**C-1025-0.125** 1/8" Collet **SN-17.5** Wrench  
**C-1025-0.250** 1/4" Collet **SN-12.7** Wrench  
**GG-43802** Collet Nut

**Michigan Pneumatic Model MP-22000 - Button Throttle Die Grinder - Side Exhaust**  
**Model MP-23000 - Lever Throttle**

Powerful die grinders designed for continuous service in industrial plants. Ideal for delicate finishing of aluminum, brass and plastic. **Parts are interchangeable with ARO 22-series short grinders. Button throttle model also available.**

Collet Size.....	1/4"	Length.....	7-3/4"
Free Speed .....	18000 rpm	Weight.....	1.9 lbs.
Spindle Thread .....	3/8"-24	Air Inlet Thread .....	1/4"
Maximum HP .....	0.7	Avg. Air Consumption .....	15.9 cfm



**G-53801** Collet Body **G-53850-0.125** 1/8" Collet  
**G-53802** Collet Nut **G-53850-0.250** 1/4" Collet

**Michigan Pneumatic Model MP-000-1 Die Grinder - Front Exhaust**

Powerful, high speed baby grinder specially designed to drive carbide burrs and rotary files for effective metal removal or delicate finishing. Ideal for production work and cleaning castings in confined areas. Lever throttle permits varying speed for greater versatility. **Parts are interchangeable with Ingersoll-Rand 00 grinder.**

Collet Size.....	1/4"	Length.....	7-1/2"
Free Speed .....	20000 rpm	Weight.....	1.50 lbs.
Maximum HP .....	0.7	Air Inlet Thread .....	1/4"
Rec'd Hose Size .....	3/8"	Avg. Air Consumption .....	15.9 cfm

# Rivet Shaver & Routers



## Hand-Held Routers



**DG20RTR**  
30000 rpm



**MP-GR2510**  
25000 rpm  
(aluminum model available)



**MP-GR1810A**  
18000 rpm  
(steel model available)



These hand-held “mini” base routers are ideal for trimming and cutting plastic parts, removing flashing from injection molded parts, wood, aluminum and fiberglass. Lightweight and easily maneuvered in tight areas. Perfect for one hand operation. **Model GR-2402 router guide not included. Please order separately.**

### GR-2402 Guide

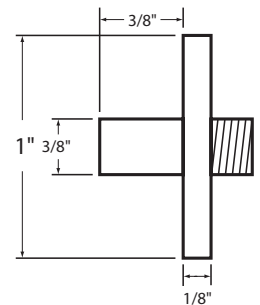

Model No.	Collet Size	Free Speed	Max. HP	Exhaust	Housing Material	Length	Weight
DG20RTR	1/4"	30000 rpm	0.60	Rear	Steel w/ Plastic Cover	9-13/16"	3.25 lbs.
MP-GR2510	1/4"	25000 rpm	1.00	Front	Steel	6-3/4"	3.25 lbs.
MP-GR2510A		25000 rpm			Aluminum		2.50 lbs.
MP-GR1810		18000 rpm			Steel		3.25 lbs.
MP-GR1810A		18000 rpm			Aluminum		2.50 lbs.

## Routers - with 6" Base



**MP-7000RTR**



**MP-2200RTR**

Model No.	Collet Size	Free Speed	Max. HP	Exhaust	Housing Material	Length	Weight	Base Diameter	Base Collar I.D.	Base Height
MP-7000RTR	1/4"	18000 rpm	0.55	Front	Aluminum	6-3/4"	2.75 lbs.	5"	1.375"	4-1/4"
MP-2200RTR			0.70			8"	4.25 lbs.	5-3/4"	1.750"	5"

## Michigan Pneumatic **MP-8009RS**

### Rivet Shaver Kit

Heavy-duty rivet shaver ideal for precision shaving of rivet heads. Designed so the skirt face is parallel to the cutter face. Spring loaded nose piece and stabilizer enables operator to feed cutter to the rivet faster and more accurately. **Includes seven skirts (as shown). Cutter bits sold separately.**



Free Speed .....	16000 rpm
Rec'd Hose Size .....	3/8"
Length .....	7-1/2"
Weight .....	3.1 lbs.
Air Inlet Thread .....	1/4"
Avg. Air Consumption .....	4 cfm



See pages 59-61 for grinder accessories.



**DG10G4**



**DG20L6**

**DG10-700-G4** Collet, 1/4" (DG10)  
**DG20-700-G4** Collet, 1/4" (DG20)

## Michigan Pneumatic

### Standard Arbor Die Grinders - Rear Exhaust

**DG Series** for metal removal and precision die grinding. Features include: Standard and extended arbor models, safety-lock lever throttle, rear exhaust, lower sound level, one-piece collet, collet and threaded spindle models, high power to weight ratio, efficient and longer lasting, and an all steel housing with cushioning sleeve. **Uses Ingersoll-Rand "New Generation" die grinder parts.**

Model No.	Collet Size	Free Speed	Max. HP	Overall Length	Weight
DG10G4	1/4"	40000 rpm	0.33	6-3/16"	1 lb.
DG20G4	1/4"	30000 rpm	0.66	7-3/4"	2 lbs.
DG20L6	3/8"-24 thrd.	30000 rpm	0.66	7-3/4"	2 lbs.



**EG10G4**



**EG20L6**

**DG10-700-G4** Collet, 1/4" (EG10)  
**DG20-700-G4** Collet, 1/4" (EG20)

## Michigan Pneumatic

### Extended Arbor Die Grinders - Rear Exhaust

**EG Series** for finishing and polishing applications, metal removal and precision die grinding. Features include: OSHA approved, extended arbor models for greater versatility, safety-lock lever throttle, rear exhaust, lower sound level, one-piece collet, collet and threaded spindle models, unusually high power and speed, and an all steel housing with cushioning sleeve. **Uses Ingersoll-Rand "New Generation" die grinder parts.**

Model No.	Collet Size	Free Speed	Max. HP	Overall Length	Weight
EG10G4	1/4"	40000 rpm	0.33	9-11/16"	1.5 lbs.
EG20G4	1/4"	30000 rpm	0.66	12-3/4"	2.5 lbs.
EG20L6	3/8"-24 thrd.	30000 rpm	0.66	12-3/4"	2.5 lbs.



**MP-9113A-14**

**C-1023N** Collet Nut  
**C-1028-0.250** Collet Insert, 1/4"  
**C-1028-0.375** Collet Insert, 3/8"  
**C-1023A-0.250** Collet Chuck Assembly, 1/4"  
**C-1023A-0.375** Collet Chuck Assembly, 3/8"  
**G-3327** Wrench  
**G-3858** Wrench

## Michigan Pneumatic

### Standard Arbor Die Grinders - Front Exhaust

Uses mounted stones, wire brushes or carbide burrs. Ideal for use in foundries, welding and fabrications shops, shipyards, rail car repair and many other industrial facilities.

Model No.	Collet Size	Free Speed	Housing	Overall Length	Weight
MP-9113-14	1/4"	25000 rpm	Steel	6-1/4"	2.25 lbs.
MP-9113-38	3/8"		Steel		2.25 lbs.
MP-9113A-14	1/4"		Aluminum		1.50 lbs.
MP-9113A-38	3/8"		Aluminum		1.50 lbs.

Maximum HP .....	1.00	Air Inlet Thread .....	1/4" NPT
Rec'd Hose Size .....	3/8"	Avg. Air Consumption .....	11.9 cfm



**MP-9113E-38**

**C-1023N** Collet Nut  
**C-1028-0.250** Collet Insert, 1/4"  
**C-1028-0.375** Collet Insert, 3/8"  
**C-1023A-0.250** Collet Chuck Assembly, 1/4"  
**C-1023A-0.375** Collet Chuck Assembly, 3/8"  
**G-3327** Wrench  
**G-3858** Wrench

## Michigan Pneumatic

### Extended Arbor Die Grinders - Side Exhaust

Uses mounted stones, wire brushes or carbide burrs. Ideal for use in foundries, welding and fabrications shops, shipyards, rail car repair and many other industrial facilities.

Model No.	Collet Size	Free Speed	Housing	Overall Length	Weight
MP-9113E-14	1/4"	25000 rpm	Steel	11-1/16"	3.30 lbs.
MP-9113E-38	3/8"		Steel		3.30 lbs.
MP-9113AE-14	1/4"		Aluminum		2.63 lbs.
MP-9113AE-38	3/8"		Aluminum		2.63 lbs.

Maximum HP .....	1.00	Air Inlet Thread .....	1/4" NPT
Rec'd Hose Size .....	3/8"	Avg. Air Consumption .....	11.9 cfm



# Collet Adapters & Extensions

## Collet Mount Adapters & Extensions

### 1/4" Collet Mount

Model No.	Hole Dia.	Wheel Width	Wheel Dia.	Screw Dia.	Length
AE-105A	3/8"	1/64" - 9/16"	3"	1"	2-1/2"
AE-106-1A		1/4" - 3/8"	3"	1"	2-1/8"
AE-124A		1/64" - 3/4"	3"	1"	2-5/8"
AE-126A		1/16" - 1/4"	2"	5/8"	2-1/8"
AE-127A		1/16" - 1/4"	3"	1"	2-13/16"



### 3/8" Collet Mount

Model No.	Hole Dia.	Wheel Width	Wheel Dia.	Screw Dia.	Length
AE-140A	3/8"	1/64" - 1/4"	3"	1"	2-1/2"
AE-141A	3/8"	1/16" - 3/4"	3"	1"	3"
AE-150A	3/8"	1/2"	3"	1"	2-5/8"
AE-226A	3/8"	1/64" - 1/2"	4"	1-1/4"	2-5/8"
AE-229A-1	1/2"	1/64" - 1/4"	4"	1-1/4"	2-5/8"



### 3/8" Collet Mount Cone and Plug Wheel

Model No.	Thread	Wheel Dia.	Length
AE-139	3/8"-24	3"	2-5/32"
AE-148	5/8"-11		2-5/32"
AE-206	5/8"-11		2-3/8"



### 1/4" Collet Mount Cone and Plug Wheel

Model No.	Thread	Wheel Dia.	Length
AE-109	5/8"-11	3"	2-5/32"
AE-123	3/8"-24		2-5/32"

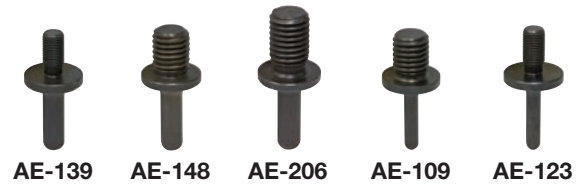

## Spindle Mount Adapters & Extensions

### 3/8"-24 Thread Mount

Model No.	Wheel I.D.	Wheel Width	Wheel Dia.	Thread	Length
AE-103A	3/8"	1/2"	3"	3/8"-24	2-1/2"
AE-115A		3/4"	3"		2-3/4"
AE-125A		3/4"	3"		2-5/8"
AE-175A		1/2"	3"		1-13/16"
AE-177A		5/8"	2"		1-15/16"



### Thread Mount Cone and Plug Wheel

Model No.	Int. Thread	Ext. Thread	Wheel Size	Length
AE-107-1	3/8"-24	5/8"-11	3"	2-1/8"
AE-107-2	1/2"-13	5/8"-11		2-1/8"
AE-107-3	3/8"-24	1/2"-20		2-1/8"
AE-118	3/8"-24	3/8"-24		2-1/8"
AE-122	3/8"-24	5/8"-11		15/16"
AE-131	3/8"-24	5/8"-11		2"
AE-176	3/8"-24	3/8"-24		13/16"
AE-182	3/8"-24	3/8"-24		3-5/16"



### 5/8"-11 Thread Mount

Model No.	Int. Thread	Ext. Thread	Wheel Size	Length
AE-211	5/8"-11 x 3/4"	5/8"-11	1-3/16"	4-1/4"
AE-212	5/8"-11 x 3-3/4"			7-1/4"



# Collet Assemblies



## Collet Chuck Assemblies

Assemblies for 1/4", 3/8" or 1/2" shank mounted wheels or rotary files. Other collets, collet inserts and collet chuck nuts available.

Model No.	Replaces	Style	Capacity	Collet Nut	Length	Internal Thread
C-1001A C-1002A	ARO #30489-1 ARO #30854-3 MPT #43801-3	2-piece 3-piece 3-piece	1/4"	C-1001N C-1002N	1-7/8" 2-1/4"	3/8"-24
C-1007A	Dresser #849142	2-piece		C-1002N C-1007N	2-1/4" 2-3/16"	
C-1008A C-1009A	I-R #ROA-390-1/4" B&D #718504	2-piece	1/4"	C-1008N C-1009N	2-1/2" 1-5/8"	3/8"-24
C-1010A	Rotor #M827-1037 B&D #44014			C-1009N C-1010N	1-5/8" 2-1/2"	
C-1012A C-1013A C-1014A	Rockwell #Y-373 Rotor #M1086-1096 Thor #70480 Thor #58980	2-piece	1/4"	C-1012N C-1012N C-1013N	1-9/16" 1-9/16" 1-5/8"	3/8"-24
C-1015A C-1016A	B&D #718590 3/8" cap. H.D. Grinders 1/2" cap.			C-1014N	2-3/16"	
C-1021A C-1023A-0.250 C-1023A-0.375	Erickson #A43807 Erickson #A34464 Erickson #A34464	2-piece 2-piece 4-piece 3-piece 3-piece	3/8" 1/2" 1/4" 1/4" 3/8"	C-1015N C-1045N C-1021N C-1023N C-1023N	2-3/8" 2-11/16" 1-3/4" 1-7/8" 1-7/8"	3/8"-24
C-1024A C-1032A C-1034A C-1035A	All H.D. Grinders ARO #41753-3 Erickson #A48590 Erickson #A16488/Double Angle	2-piece 3-piece 4-piece 3-piece	1/4"	C-1010N C-1032N C-1021N C-1035N	2-5/8" 2-1/4" 1-3/4" 2-1/16"	1/2"-13 3/8"-24 5/16"-24 3/8"-24
C-1036A C-1039A C-1049A-5/7/9	CP #C-069969 I-R #ROA-390-1/4" ARO #30385-1	2-piece		1/4"	C-1036N C-1039N C-1049N	3-1/2" 3-1/8" 5"7/8"/9"
C-1056A C-1060A C-1070A	All H.D. Grinders CP #S-0066271Y B&D #44016	2-piece	1/4"	C-1039N C-1013N C-1070N	3-1/8" 2-3/16" 2-5/8"	1/2"-13 3/8"-24 3/8"-24
C-1079A-0.250 C-1079A-0.375			3-piece	1/4" 3/8"	C-1079N C-1079N	2-1/4"
C-1084A-0.250 C-1084A-0.375 C-1084A-0.500		3-piece	1/4" 3/8" 1/2"	C-1084N	2-1/2"	3/8"-24
C-1084A-1220-0.250 C-1084A-1220-0.375 C-1084A-1220-0.500			3-piece			
C-1104A C-1114A		2-piece	1/4" 3/8"	C-1107N	3-1/8" 3"	5/8"-11



### 3 & 4 Piece Assemblies



# Collet Inserts, Nuts & Adapters



## Collet Inserts

Replacement collet inserts for collet chuck assemblies.

Model No.	Replaces	Size
C-1025-0.125 C-1025-0.250	ARO #30847; MP #44850	1/8" 1/4"
C-1026-0.250	(not shown)	1/4"
C-1027-0.125 C-1027-0.1875 C-1027-0.250	ARO #31812; B&D #44001; CP #C110299Y; I-R #G120-700; Rotor #1233-1317	1/8" 3/16" 1/4"
C-1028-0.125 C-1028-0.1875 C-1028-0.250 C-1028-0.375	ARO #32968; CP #C119729Y; I-R #G140-700	1/8" 3/16" 1/4" 3/8"
C-1030-0.125 C-1030-0.250	B&D #71852 (not shown)	1/8" 1/4"
C-1033-0.125 C-1033-0.250	ARO #41750	1/8" 1/4"
C-1074-0.125 C-1074-0.250	CP #KF124524-C-138727; Rockwell #92233; UPI #1610 & #551	1/8" 1/4"
C-1093-0.125 C-1093-0.1875 C-1093-0.250	B&D #718524-3/16" & #718525-3/32"; Rockwell #1006647	1/8" 3/16" 1/4"



## Collet Chuck Nuts

Collet chuck nuts are available for all collet chucks.

Model No.	Replaces
C-1005N C-1009N C-1023N	I-R #308-699; CP #KF-124525 B&D #718519; Master #550-35 ARO #44129; CP #C-122770; Dotco #2058
C-1062N C-1091N TP10742	I-R #G140-699; ATS #C-1023N Gardner-Denver #10549-525354 Nitto Kohki MAS-20B



## Collet Adapters

These adapters permit the use of various mounted wheels or burrs without changing collet chucks. All adapters are made with a shoulder to aid in removal with a minimum of inconvenience.

Model No.	Replaces
C-1040-0.0937 C-1040-0.1562 C-1040-0.125 C-1040-0.1875 C-1042 C-1043 C-1044 C-1048	1/4" to 3/32" 1/4" to 5/32" 1/4" to 1/8" 1/4" to 3/16" 3/8" to 1/4" 1/2" to 3/8" 1/2" to 1/4" 3/8" to 5/16"



See pages 59-60 & 72-73 for additional grinder accessories.

# Extended Arbor Grinders



Nippon Pneumatic

## Straight Collet Grinders

Lightweight aluminum grinder with narrow housing allows operator access to difficult areas. Ideal for one hand operation. Integrated safety throttle mechanism assures operator safety. **Not equipped with wheel guard.** 6mm collet grinders also available.

# NPK®

- 15003420** Collet Nut
- 15003430** Collet Washer
- 15003410** 6mm Collet Body (3/8"-16)
- 15003540** 1/4" Collet Body (3/8"-16)
- SN-17** Open End Wrench
- TSP-28** Spanner Wrench

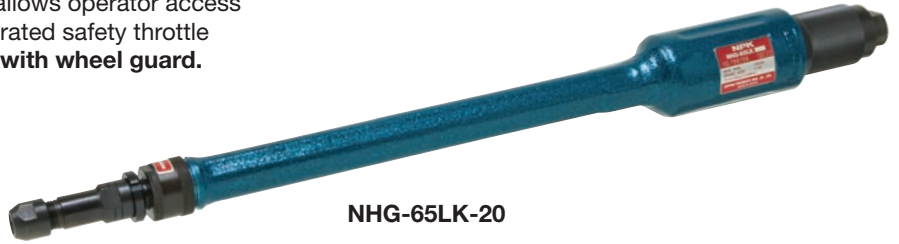

NHG-65LK-20



NHG-65KLW-20



NHG-65LKLW-20

Model No.	Collet Size	Free Speed	Spindle Thread	Throttle Style	Maximum HP	Length	Weight	Rec'd Hose Size	Air Inlet Thread	Avg. Air Consumption
NHG-65K-20	1/4"	18000 rpm	3/8"-16	Safety Roll	1.0	12-3/16"	2.9 lbs.	3/8"	1/4"	19.4 cfm
NHG-65KLW-20				Safety Lever		13-5/16"	2.9 lbs.			
NHG-65LK-20				Safety Roll		20-1/16"	3.5 lbs.			
NHG-65LKLW-20				Safety Lever		21-3/16"	3.5 lbs.			

Nippon Pneumatic

## Straight Wheel Grinders

Ideal for boiler tube applications and grinding or deburring deep, intricate castings. Light, aluminum housing and safety throttle allows for safe, maneuverable grinding. Removes metal fast. **NHG-65D Series equipped with wheel guard. Wheel not included.**

# NPK®

- 28100387** Hex Nut (3/8"-16)
- 28100380** Hex Nut (3/8"-16)
- 28100390** Hex Nut (3/8"-24)
- 28100382** Hex Nut (3/8"-24)
- 15003420** Collet Nut
- 15500050** 1/4" Collet Body (3/8"-24)
- TSP-28** Spanner Wrench



NHG-65LDLW



NHG-65ALW



NHG-65LAULW

Model No.	Wheel Capacity	Free Speed	Spindle Thread	Throttle Style	Maximum HP	Length	Weight	Rec'd Hose Size	Air Inlet Thread	Avg. Air Consumption
NHG-65D	2-1/2" x 1/2" x 3/8"	14600 rpm	3/8"-16	Safety Roll	1.0	12-3/16"	2.9 lbs.	3/8"	1/4"	19.4 cfm
NHG-65DLW				Safety Lever		13-5/16"	2.9 lbs.			
NHG-65LD				Safety Roll		20-1/16"	3.5 lbs.			
NHG-65LDLW				Safety Lever		21-3/16"	3.5 lbs.			
NHG-65ALW	2" x 1/2" x 3/8"	18000 rpm	3/8"-16	Safety Lever	1.0	11-21/32"	2.4 lbs.	3/8"	1/4"	19.4 cfm
NHG-65LAULW			3/8"-24			19-17/32"	3.1 lbs.			



# Wheel Grinders & Belt Attachments



Michigan Pneumatic Models MP-1012-CWHL, MP-1012 and MP-1012-BGA12/MP-1012-BGA21

## Straight and Cone Wheel Grinders



The **MP-1012-CWHL** is a small, lightweight, easy to handle grinder. Designed for production grinding of small concave surfaces, especially in close quarters. Ideally used for rotary file burring and for small cone wheel grinding. **1/4" collets available.**

The **MP-1012** is specially designed for radial wheel grinding projects where lightweight and small size are important. Desirable tool for production grinding of small concave surfaces, deep crevices and pockets. **1/4" collets available.**

**MP-1012-BGA12** or **MP-1012-BGA21** grinder with the Port-A-Belt attachment effectively reduces production costs. The Port-A-Belt conforms to convex or concave surfaces and irregular shapes, which results in more uniform contours. Cool running and greater surface contact allows for a finer finish. **Extra belts available. Two models available. See chart below.**

Specifications	MP-1012-CWHL	MP-1012	MP-1012-BGA Series
Capacity	Cone Wheel	3" x 1/2" (flat wheel)	12" x 1" (belt)
Free Speed	12000 rpm	12000 rpm	12000 rpm
Spindle Thread	3/8"-24	3/8"-24	3/8"-24
Maximum HP	1.00	1.00	1.00
Length	11-1/2"	11-1/2"	14"
Weight	3.8 lbs.	4.4 lbs.	5.7 lbs.
Air Inlet Thread	1/4"	1/4"	1/4"
Avg. Air Consumption	20 cfm	20 cfm	20 cfm

## Port-A-Belt Grinding Attachments

Contact Wheel (idler)



BGA12 and BGA24 Series

Ideal for sanding concave or convex surfaces. **Available with rubber contact wheel on spindle or on idler. Please specify tool model number or mounting clamp bore diameter.**

Accessory for MPT Tool Model	Order Attachment Part No.	Idler Contact Wheel Dia.	Contact Wheel Part No.	Belt Size L x W	Rec'd Speed
MP-79000	BGA12-1.250	2"	B8661	12" x 1"	18000 rpm
MP-1012	BGA12-1.560	2"	B8661	12" x 1"	12000 rpm
NHG-150	BGA24-2.250	4"	G8629	20" x 2"	6000 rpm

## Extra Belts & Contact Wheels

- B8661** Contact Wheel
- G8629** Contact Wheel
- B8459** Contact Wheel
- G8440** Contact Wheel

Part No.	Belt Size L x W	Grit
60145		80
60146	12" x 1"	100
60147		120
60608A		80
60609A	20" x 2"	100
60610A		120



Contact Wheel (spindle)

BGA21 and BGA42 Series

Accessory for MPT Tool Model	Order Attachment Part No.	Spindle Contact Wheel Dia.	Contact Wheel Part No.	Belt Size L x W	Rec'd Speed
MP-79000	BGA21-1.250	2"	B8459	12" x 1"	18000 rpm
MP-1012	BGA21-1.560	2"	B8459	12" x 1"	12000 rpm
NHG-150	BGA42-2.250	4"	G8440	20" x 2"	6000 rpm

See pages 59-61 & 72-73 for grinder accessories.



MP-79000B



Wheel not included

Michigan Pneumatic **Model MP-79000B** - Button Throttle  
**Model MP-79000L** - Lever Throttle

## 2" Straight Grinder - with Guard

Powerful, lightweight grinder designed to ensure easy handling. Ideal for grinding small radius concave surfaces and grinding in confined spaces. Built-in speed regulator is standard. 1/4" collets and belt grinding attachments available. Parts are interchangeable with the ARO 22-Series 2" grinder.

Wheel Capacity .....	2" x 1/2"	Length .....	12"
Free Speed .....	18000 rpm	Weight .....	3.25 lbs.
Spindle Thread .....	3/8"-24	Air Inlet Thread .....	1/4"
Maximum HP .....	0.7	Avg. Air Consumption .....	15.9 cfm



Wheel not included

Michigan Pneumatic **Model MP-9113A-EW**

## 3" Straight Grinder - with Guard

Designed for casting cleanup, smoothing welds and burr removal in fabrication shops and shipyards. Features a lightweight aluminum body and side exhaust.

Wheel Capacity .....	3" x 1/2"	Length .....	13-1/2"
Free Speed .....	18000 rpm	Weight .....	3.00 lbs.
Spindle Thread .....	3/8"-24	Air Inlet Thread .....	1/4"
Maximum HP .....	1.00	Avg. Air Consumption .....	11.9 cfm



Wheel not included

Michigan Pneumatic **Model MP-9115-EW**

## 3" Straight Grinder - with Guard

Ideal for use in shipyards, refineries and fabrication shops. Features safety lever throttle, side exhaust and steel housing.

Wheel Capacity .....	3" x 1/2"	Length .....	13-1/2"
Free Speed .....	18000 rpm	Weight .....	4.00 lbs.
Spindle Thread .....	3/8"-24	Air Inlet Thread .....	1/4"
Maximum HP .....	1.00	Avg. Air Consumption .....	11.9 cfm



Cone Wheel not included

Michigan Pneumatic **Model MP-2511**

## Cone Wheel Grinder

Designed for production grinding of small concave surfaces, especially in close quarters. Ideally used for rotary file burring and for small cone wheel grinding.

Wheel Capacity .....	Cone Wheel	Length .....	18"
Speed .....	12000 rpm	Weight .....	6.75 lbs.
Spindle Thread .....	5/8"-11	Air Inlet Thread .....	1/2"
Maximum HP .....	1.50	Avg. Air Consumption .....	32 cfm



Wheel not included

Michigan Pneumatic **Model MP-2**

## 5" Straight Grinder - with Guard

Best suited for cleaning castings, removing fins, grinding welds, and buffing sheet metal. Designed to be light and sturdy for effective metal removal. Built-in lubricator and automatic governor provide lifelong dependability.

Wheel Capacity .....	5" x 3/4"	Length .....	17"
Free Speed .....	7500 rpm	Weight .....	7.25 lbs.
Spindle Thread .....	1/2"-13	Air Inlet Thread .....	3/8"
Maximum HP .....	1.50	Avg. Air Consumption .....	32 cfm

# Straight Wheel Grinders - Industrial



**NPK®**



NHG-100A



Wheel not included

Nippon Pneumatic **Model NHG-100ALW - Safety Lever Throttle**  
**Model NHG-100A - Safety Roll Throttle**

## 4" Straight Grinder - with Guard

High speed straight grinder designed for continuous duty production work in grinding, wire brushing and polishing. Powerful, with a quick acting throttle to provide balanced, easy handling for efficient metal removal. **For all industrial applications in foundries and shipyards.**

Wheel Capacity .....	4" x 5/8"	Length .....	15-1/2"
Free Speed .....	9500 rpm	Weight .....	5.25 lbs.
Spindle Thread .....	1/2"-13	Air Inlet Thread .....	3/8"
Maximum HP .....	1.00	Avg. Air Consumption .....	23 cfm

**NPK®**



NHG-125



Wheel not included

Nippon Pneumatic **Model NHG-125LW - Safety Lever Throttle**  
**Model NHG-125 - Safety Roll Throttle**

## 5" Straight Grinder - with Guard

Best suited for cleaning castings, removing fins, grinding welds, and buffing sheet metal. Designed to be light and sturdy for effective metal removal. Built-in lubricator and automatic governor provide lifelong dependability.

Wheel Capacity .....	5" x 3/4"	Length .....	17-13/16"
Free Speed .....	7500 rpm	Weight .....	7.0 lbs.
Spindle Thread .....	1/2"-12	Air Inlet Thread .....	3/8"
Maximum HP .....	1.10	Avg. Air Consumption .....	32 cfm

**NPK®**



NHG-150



Wheel not included

Nippon Pneumatic **Model NHG-150LW - Safety Lever Throttle**  
**Model NHG-150 - Safety Roll Throttle**

## 6" Straight Grinder - with Guard

Powerful grinders for use with resinoid wheels. Designed to be lightweight for easier handling, and powerful for the heaviest work. Speed regulator provides constant speed according to wheel diameter. Perfect for all industrial applications.

Wheel Capacity .....	6" x 1"	Length .....	17-1/4"
Free Speed .....	6200 rpm	Weight .....	9.5 lbs.
Spindle Thread .....	5/8"-11	Air Inlet Thread .....	3/8"
Maximum HP .....	2.00	Avg. Air Consumption .....	39 cfm

Wheel not included

Michigan Pneumatic **Model MP-5666HS**

## 6" Straight Grinder - with Guard

Heavy-duty grinder for cleaning castings, smoothing, finishing, snagging welds, removing scale, rust and weld splatter. Used for a variety of applications in fabrication shops, refineries, foundries, shipyards and steel mills. Features a high force, corrosion resistant governor to retain optimum grinding efficiency. **Model MP-5648HS 4500 rpm, 8" horizontal grinder also available.**

Speed .....	6000 rpm	Length .....	20-1/8"
Wheel Capacity .....	6" x 1"	Weight .....	10.5 lbs.
Spindle Thread .....	5/8"-11	Air Inlet Thread .....	1/2"
Maximum HP .....	3.00	Avg. Air Consumption .....	45 cfm



Wheel not included

Michigan Pneumatic **Model MP-6648HS**

## 8" Straight Grinder - with Guard

Heavy-duty grinder for cleaning castings, smoothing, finishing, snagging welds, removing scale, rust and weld splatter. Used for a variety of applications in fabrication shops, refineries, foundries, shipyards and steel mills. Features an aircraft grade aluminum housing. **Model MP-6666HS 6000 rpm, 6" horizontal grinder also available.**

Speed .....	4500 rpm	Length .....	20-7/8"
Wheel Capacity .....	8" x 1"	Weight .....	12.5 lbs.
Spindle Thread .....	5/8"-11	Air Inlet Thread .....	1/2"
Maximum HP .....	4.00	Avg. Air Consumption .....	50 cfm

# Right Angle Grinders



3-1/4"



Wheel not included

## Michigan Pneumatic Model MP-250L-ST

### 4" Angle Grinder - with Guard

Rugged, lightweight angle grinder for many applications. Removes rust and paint fast. Great for dressing up welds and grinding complex shapes. Features safety lever throttle and governor. **Uses 4" x 5/8" hole, type 27, depressed center grinding wheels.**

Capacity.....4"	Length.....9"
Free Speed .....12000 rpm	Weight.....4.5 lbs.
Spindle Thread .....3/8"-24	Air Inlet Thread .....1/4"
Maximum HP .....1.00	Avg. Air Consumption .....10 cfm



3-1/4"



Wheel not included

## Michigan Pneumatic Model MP-1FB

### 4" Angle Grinder - with Guard

Small, rugged, versatile angle grinder will do a multitude of jobs with minimum operator fatigue. Heavy enough to remain stable, yet light enough to be maneuvered easily around complex shapes. **1/4" collets available for collet grinding. Features safety lever throttle.**

Capacity.....4"	Length.....9"
Free Speed .....12700 rpm	Weight.....3.5 lbs.
Spindle Thread .....3/8"-24	Air Inlet Thread .....1/4"
Maximum HP .....1.00	Avg. Air Consumption .....24 cfm



2-1/2"



Wheel not included

## Michigan Pneumatic Model MP-3040

### 4" Angle Grinder - with Guard

Ideal for industrial applications including welding shops, foundries, fabrication plants, steel mills and shipyards. **Model MP-3040A with aluminum housing and MP-3040-E4 extended angle grinder also available.**

Capacity.....4"	Length.....8"
Free Speed .....13500 rpm	Weight.....3.125 lbs.
Spindle Thread .....3/8"-24	Air Inlet Thread .....1/4"
Maximum HP .....1.00	Avg. Air Consumption .....11.9 cfm



2-1/2"



Wheel not included

## Michigan Pneumatic Model MP-3040-E4

### 4" Angle Grinder - with Guard

Rugged 1HP motor angle grinder designed for cleaning, deburring, smoothing and blending. Ideal for foundries, shipyards and fabrication shops. **Features adjustable side exhaust. Model MP-3040A-E4 with aluminum motor housing available.**

Capacity.....4"	Length.....10"
Free Speed .....13500 rpm	Weight.....3.5 lbs.
Spindle Thread .....3/8"-24	Air Inlet Thread .....1/4"
Maximum HP .....1.00	Avg. Air Consumption .....11.9 cfm



2-1/2"



Wheel not included

## Michigan Pneumatic Model MP-314

### 4" Angle Grinder - with Guard

Features a floating rotor design extending the operational life of the tool by reducing wear on critical components. Compact, adjustable angle head is ideal for close quarter applications.

Capacity.....4"	Length.....10"
Free Speed .....13500 rpm	Weight.....2.9 lbs.
Spindle Thread .....3/8"-24	Air Inlet Thread .....1/4"
Maximum HP .....1.00	Avg. Air Consumption .....12 cfm

# Right Angle Grinders



3-1/4"



Wheel not included

## Michigan Pneumatic Model MP-250L-ST58

### 5" Angle Grinder - with Guard

Durable, right angle grinder used for grinding, deburring and blending. Rugged, lightweight angle grinder for many applications. Removes rust and paint fast. Great for dressing up welds and grinding complex shapes. Features safety lever throttle and governor. **Equipped with 5" guard and dead handle.**

Capacity.....	5"	Length.....	9"
Free Speed.....	12000 rpm	Weight.....	4.5 lbs.
Spindle Thread.....	5/8"-11	Air Inlet Thread.....	1/4"
Maximum HP.....	1.00	Avg. Air Consumption.....	10 cfm



3-3/4"



Wheel not included

## Michigan Pneumatic Model MP-1954PS-ST

### 5" Angle Grinder - with Guard

**Features rear exhaust.** Lightweight, heavy-duty angle grinder with adjustable swivel guard and reduced vibration dead handle. Change abrasives easier using the integrated spindle lock mechanism. **Equipped with 5" guard and dead handle.**

Capacity.....	5"	Length.....	9-13/32"
Free Speed.....	10000 rpm	Weight.....	4.4 lbs.
Spindle Thread.....	5/8"-11	Air Inlet Thread.....	1/4"
Maximum HP.....	0.87	Avg. Air Consumption.....	4 cfm



3-3/4"



Wheel not included

## Michigan Pneumatic Model MP-11650

### 5" Angle Grinder - with Guard

**Features adjustable side exhaust.** All steel housing with safety lever throttle. Used for grinding, deburring and blending. Features a wick-type lubrication system and spiral beveled gears. **Model MP-11650A with aluminum motor housing available. Equipped with 5" guard and dead handle.**

Capacity.....	5"	Length.....	7-1/2"
Free Speed.....	11000 rpm	Weight.....	5 lbs.
Spindle Thread.....	5/8"-11	Air Inlet Thread.....	1/4"
Maximum HP.....	1.00	Avg. Air Consumption.....	11.9 cfm



4-3/8"



Wheel not included

## Nippon Pneumatic Model NAG-11A-U5

### 5" Angle Grinder - with Guard

**Features rear exhaust.** Change abrasive in seconds. No more fumbling with multiple wrenches. Simply depress the spindle locking mechanism on top of the housing and remove the abrasive product. Features a left or right hand dead handle, two-step safety lever throttle, and a composite plastic handle. **Equipped with 5" guard and dead handle.**

Capacity.....	5"	Length.....	9-7/8"
Free Speed.....	12000 rpm	Weight.....	4.5 lbs.
Spindle Thread.....	5/8"-11	Air Inlet Thread.....	3/8"
Maximum HP.....	0.87	Avg. Air Consumption.....	28 cfm



4-3/16"



Wheel not included

## Nippon Pneumatic Model NAG-70ALW

### 7" Angle Grinder - with Guard

**Features side exhaust.** Heavy-duty grinder designed for continuous service. Lever type throttle allows operator to run full speed for metal removal or throttle down for delicate work. **Equipped with 7" guard and dead handle. Model NAG-70ALWSS with 5/8"-11 threaded spindle also available, allowing for the use of type 27 threaded hubs.**

Capacity.....	7"	Length.....	11-1/32"
Free Speed.....	7600 rpm	Weight.....	6.8 lbs.
Spindle Thread.....	5/8"-11	Air Inlet Thread.....	3/8"
Maximum HP.....	1.30	Avg. Air Consumption.....	42 cfm

# Right Angle Grinders & Sanders



MP-6166-ST



MP-3765-ST



MP-717-ST

Quality beveled gears, ball bearing construction and powerful **1HP motor** offer unmatched performance for the toughest sanding/grinding jobs. Lightweight aluminum housing to reduce operator fatigue. **Grinding wheel not included.**

Model No.	Capacity	Free Speed	Spindle Thread	Height	Length	Weight	Air Inlet Thread	Avg. Air Consumption
MP-6166-ST	7"	2500 rpm	5/8"-11	4"	12"	4.40 lbs.	1/4"	6 cfm
MP-3765-ST		4500 rpm		4"	12-3/4"	4.75 lbs.	1/4"	9 cfm
MP-717-ST		6000 rpm		4-1/4"	13-1/2"	8.00 lbs.	3/8"	9 cfm



5-3/8"

Wheel not included

## Michigan Pneumatic Model MP-2FA Angle Grinder - with Guard

Rugged, unusually powerful, heavy-duty tool for steady production grinding. Maintains cutting speed under load. Removes metal fast with less operator effort. **Available with cup wheel or wire brush for grinding, or rubber pad for sanding. Model MP-2FA-ROLL with roll type throttle available.**

Capacity .....	7"	Length .....	12-5/8"
Free Speed .....	7100 rpm	Weight .....	9 lbs.
Spindle Thread .....	5/8"-11	Air Inlet Thread .....	3/8"
Maximum HP .....	1.50	Avg. Air Consumption .....	42 cfm



5-3/8"

Wheel not included

## Michigan Pneumatic Model MP-2FW Angle Grinder - with Guard

Powerful heavy-duty grinder designed to withstand the continuous service encountered in plants. Lever type throttle allows operator to throttle down for delicate work or run full speed for maximum metal removal. **Equipped with a lever throttle. Available with wire brush. Model MP-2FW-ROLL with roll type throttle available. Optional cup guard also available.**

Capacity .....	9"	Length .....	12-5/8"
Free Speed .....	5500 rpm	Weight .....	9.5 lbs.
Spindle Thread .....	5/8"-11	Air Inlet Thread .....	3/8"
Maximum HP .....	1.50	Avg. Air Consumption .....	42 cfm



MP-1165-WATER



MP-3760-WATER



MP-7170-WATER

Quality beveled gears, ball bearing construction and powerful **1HP motor** offer unmatched performance for the toughest sanding/grinding jobs. Lightweight aluminum housing to reduce operator fatigue. **Wheel not included.**

Model No.	Capacity	Free Speed	Spindle Thread	Height	Length	Weight	Air Inlet Thread	Avg. Air Consumption
MP-1165-WATER	5"	11000 rpm		4-1/4"	7-1/2"	4.25 lbs.		11.9 cfm
MP-3760-WATER	7"	4500 rpm	5/8"-11	4"	12-3/4"	5.50 lbs.	1/4"	9.0 cfm
MP-7170-WATER	7"	6000 rpm		4-1/4"	13-1/2"	8.75 lbs.		9.0 cfm



5-3/8"

Wheel not included

## Michigan Pneumatic Model MP-2FA-WATER Extra Heavy-Duty Water Feed Sander/Grinder

Heavy-duty grinder designed for continuous service. Lever type throttle allows operator to run full speed for metal removal or throttle down for delicate work. **Equipped with dead handle 7" guard and 6 ft. hose with standard water faucet connector. Available with cup wheel or wire brush for grinding, or rubber pad for sanding.**

Capacity .....	7"	Length .....	12-5/8"
Free Speed .....	7100 rpm	Weight .....	10.25 lbs.
Spindle Thread .....	5/8"-11	Air Inlet Thread .....	3/8"
Maximum HP .....	1.50	Avg. Air Consumption .....	42 cfm



5-3/8"

Wheel not included

## Michigan Pneumatic Model MP-2FW-WATER Extra Heavy-Duty Water Feed Sander/Grinder

Rugged, unusually powerful, heavy-duty tool for steady production grinding. Maintains cutting speed under load. Removes metal fast with less operator effort. **Equipped with dead handle, 9" guard and 6 ft. hose with standard water faucet connector. Available with cup wheel or wire brush for grinding, or rubber pad for sanding. Model MP-2FWRT-WATER with roll type throttle available.**

Capacity .....	9"	Length .....	12-5/8"
Free Speed .....	5500 rpm	Weight .....	10.75 lbs.
Spindle Thread .....	5/8"-11	Air Inlet Thread .....	3/8"
Maximum HP .....	1.50	Avg. Air Consumption .....	42 cfm

# Vertical Grinders



## Michigan Pneumatic Model MP-5666VSC

### Vertical Grinder - with Cup Wheel Guard

Features a high force, corrosion resistant governor to retain optimum grinding efficiency and hardened steel motor parts. Provides heavy-duty grinding for smoothing; finishing, removing scale, rust and weld splatter; cleaning castings and masonry work. Ideal for a variety of applications in fabrication shops, refineries, shipyards, steel mills and construction sites.

**MP-5646VSC 4500 rpm, 6" cup wheel grinder also available.**



Wheel not included

Capacity.....	6" Cup Wheel	Height.....	7-3/4"
Free Speed .....	6000 rpm	Weight.....	10.25 lbs.
Spindle Thread .....	5/8"-11	Rec'd Hose Size .....	1/2"
Maximum HP .....	3.00	Air Inlet Thread .....	1/2"

## Michigan Pneumatic Model MP-5667VS

### Vertical Grinder - with Guard

Features include hardened steel motor parts and a high force, corrosion resistant governor to retain optimum grinding efficiency. Ideal for heavy-duty grinding for smoothing; finishing, removing scale, rust and weld splatter; cleaning castings and masonry work. Applications include fabrication shops, refineries, shipyards, steel mills and construction sites.



Wheel not included

Capacity.....	7"	Height.....	7-5/8"
Free Speed .....	6000 rpm	Weight.....	9.60 lbs.
Spindle Thread .....	5/8"-11	Rec'd Hose Size .....	1/2"
Maximum HP .....	3.00	Air Inlet Thread .....	1/2"

## Michigan Pneumatic Model MP-6666VSC

### Vertical Grinder - with Cup Wheel Guard

Ideal for fabrication shops, refineries, shipyards, steel mills and construction sites. Features a high force, corrosion resistant governor to retain optimum grinding efficiency and hardened steel motor parts. Provides heavy-duty grinding for smoothing; finishing, removing scale, rust and weld splatter; cleaning castings and masonry work. **MP-6646VSC 4500 rpm, 6" cup wheel grinder also available.**



Wheel not included

Capacity.....	6" Cup Wheel	Height.....	8-5/16"
Free Speed .....	6000 rpm	Weight.....	11.0 lbs.
Spindle Thread .....	5/8"-11	Rec'd Hose Size .....	1/2"
Maximum HP .....	4.00	Air Inlet Thread .....	1/2"

## Michigan Pneumatic Model MP-6669VS

### Vertical Grinder - with Guard

Features a high force, corrosion resistant governor to retain optimum grinding efficiency and hardened steel motor parts. Provides heavy-duty grinding for smoothing; finishing, removing scale, rust and weld splatter; cleaning castings and masonry work. Ideal for a variety of applications in fabrication shops, refineries, shipyards, steel mills and construction sites. **MP-6667VS 7" vertical grinder also available.**



Wheel not included

Capacity.....	9"	Height.....	8-3/16"
Free Speed .....	6000 rpm	Weight.....	10.90 lbs.
Spindle Thread .....	5/8"-11	Rec'd Hose Size .....	1/2"
Maximum HP .....	4.00	Air Inlet Thread .....	1/2"



# Vertical Grinders



## Michigan Pneumatic Model MP-5669VS

### Vertical Grinder - with Guard

Features include hardened steel motor parts and a high force, corrosion resistant governor to retain optimum grinding efficiency. Ideal for heavy-duty grinding for smoothing; finishing, removing scale, rust and weld splatter; cleaning castings and masonry work. Applications include fabrication shops, refineries, shipyards, steel mills and construction sites.



Wheel not included

Capacity.....	9"	Height.....	7-5/8"
Free Speed .....	6000 rpm	Weight.....	10.25 lbs.
Spindle Thread .....	5/8"-11	Rec'd Hose Size .....	1/2"
Maximum HP .....	3.00	Air Inlet Thread .....	1/2"

## Michigan Pneumatic Model MP-B6001M-45

### Vertical Grinder - with Cup Wheel Guard

Vertical grinder designed for tough, extra-duty grinding jobs. Outstanding for general clean-up of all size castings, removal of scale, rust or paint by wire brushing and grinding butt welds. Provides maximum power under the worst operating conditions. Lightweight alloy housing allows for easy control and handling. **6" cup wheel guard with butterfly throttle is standard. Optional 9" wheel guard available. Parts are interchangeable with the Master and B&D 601 grinders.**



Wheel not included

Capacity.....	6" Cup Wheel	Height.....	8"
Free Speed .....	4500 rpm	Weight.....	12 lbs.
Spindle Thread .....	5/8"-11	Rec'd Hose Size .....	1/2"
Maximum HP .....	3.00	Air Inlet Thread .....	1/2"

## Michigan Pneumatic Model MP-B3199C-45

### Vertical Grinder - with Cup Wheel Guard

Heavy-duty surface grinder designed for continuous production sanding and grinding in industrial plants. Will handle a large variety of surface grinding applications. Ideal for smoothing flat surfaces and cutting down high spots. Lightweight and easy to handle. **Parts are interchangeable with the CP Model 319 grinder. Features safety lever throttle.**



Wheel not included

Capacity.....	6" Cup Wheel	Height.....	7-3/8"
Free Speed .....	4500 rpm	Weight.....	8.5 lbs.
Spindle Thread .....	5/8"-11	Rec'd Hose Size .....	1/2"
Maximum HP .....	2.00	Air Inlet Thread .....	1/2"

## Michigan Pneumatic Model MP-B3199CLW-6

### Vertical Grinder - with Guard

Best suited for grinding and sanding flat surfaces. Ideal for sheet metal finishing, cleaning and grinding castings, and smoothing welds. Perfect for cup wheel grinding, cup wire brushing and disc sanding. Designed for heavy-duty use. **Parts are interchangeable with the CP Model 319 grinder. Features safety lever throttle.**



Wheel not included

Capacity.....	7"	Height.....	7-3/8"
Free Speed .....	6000 rpm	Weight.....	8.5 lbs.
Spindle Thread .....	5/8"-11	Rec'd Hose Size .....	1/2"
Maximum HP .....	2.00	Air Inlet Thread .....	1/2"



## Spiralcool Air-Cooled Backing Pads

Spiralcool air cooled pads feature reduced loading and increased disc life. Ideal for all sanding operations on metal, fiberglass and plastics. Flexible or medium grade recommended for contour work and rigid for straight edge work. **Fits any sander or grinder with 5/8"-11 thread.**

Part Number			Size
Flexible	Medium	Rigid	
F400-R	R400-R	H400-R	4"
F500-R	R500-R	H500-R	5"
F600-R	R600-R	H600-R	6"
F700-R	R700-R	H700-R	7"
F800-R	R800-R	H800-R	8"
F900-R	R900-R	H900-R	9"



## Sav-A-Disc Backing Plate

Unique rib design prevents the abrasive disc from loading when grinding results in more than 3 times normal disc wear. **Includes 7" and 9" plates.**

- Cuts faster
- Results in cool grinding
- Reduces worker fatigue
- Increases disc life
- Patented free wheeling hub
- 5/8"-11 arbor



BP-1 Set

## Twist Knotted Cup Brushes

Well suited for use on portable equipment for cleaning and removing rust, scale and paint on flat and contoured surfaces. **Flat knot type wire wheels available.**



Part No.	Dia.	Wire Size	Arbor Hole	Trim Length	Max. RPM
<b>Single Row, Twist Tuft Cup Brushes</b>					
03407	4"	.020"	5/8"-11	1-3/8"	9000
03409	6"	.020"	5/8"-11	1-3/4"	6600
03410	6"	.035"	5/8"-11	1-3/4"	6600
<b>Double Row, Twist Tuft Cup Brushes</b>					
03411	6"	.020"	5/8"-11	1-3/4"	6600
03412	6"	.035"	5/8"-11	1-3/4"	6600

## Crimped Wire Cup Brushes

Hard working cups with solid ring construction designed for safer brushing action. Very popular in auto body shops for removal of paint and plastic body filler.



Part No.	Dia.	Wire Size	Arbor Hole	Trim Length	Max. RPM
09551	4"	.020"	5/8"-11	1-1/8"	9000
09552	5"	.020"	5/8"-11	1-1/2"	8000
09553	6"	.020"	5/8"-11	1-1/2"	6600

## Twist Knot Flat Wire Wheels



## Grinding Wheels with Depressed Center

MPT abrasive grinding wheels are reinforced with fiberglass to ensure safe operation and long life. In use, natural pores are created as the special resinoid fillers are melted by grinding heat, constantly renewing high cutting efficiency.

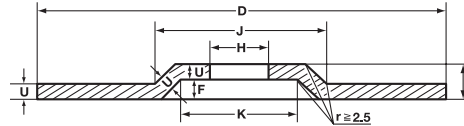

### Type 27 Depressed Center Wheel with Through Hole

Part No.	Diameter "D"	Thick "U"	Hole "H"	RPM
T27-41858	4"	1/8"	5/8"	13500
T27-41458	4"	1/4"	5/8"	13500
T27-71878	7"	1/8"	7/8"	8500
T27-71478	7"	1/4"	7/8"	8500
T27-91878	9"	1/8"	7/8"	6500
T27-91478	9"	1/4"	7/8"	6500

### Type 27 Depressed Center Wheel with 5/8"-11 Threaded Hub

Part No.	Diameter "D"	Thick "U"	Hole "H"	RPM
20163	4-1/2"			13300
20173	5"			12200
20086	7"	1/4"	5/8"-11	8500
20096	9"			6500

Standard tufts are twisted 2/3 of their length. Satisfactory for the majority of applications where severe cleaning action is required. **Stainless wheels available.**

Part No.	Dia.	Wire Size	Arbor Hole	Trim Length	Max. RPM
03377	3"	.014"	3/8"	11/16"	20000
03378	4"	.014"	1/2"	7/8"	20000
03386	6"	.020"	5/8"-1/2"	1-7/16"	9000
03426		.014"	5/8"-11		
03430	4"	.014"	1/2"-13	7/8"	20000
03460		.020"	5/8"-11		



## JET Bench Grinders



JBG-6A

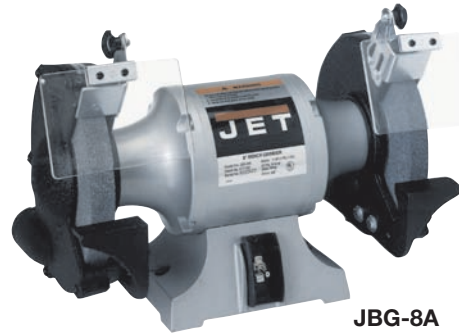

JBG-8A

Designed and manufactured for continuous industrial service. All models feature pre-lubricated and enclosed ball bearings, cast iron wheel guards and dust vents. All models also include adjustable one-piece spark guards, large eye shields and tool rests. **OSHA approved.**

Model No.	Dimensions	Wheel Size	Motor	Speed	Weight
JBG-6A	18" x 10-1/2" x 8-1/2"	6" x 3/4" x 1/2"	1/2 HP	3450 rpm	32 lbs.
JBG-8A	19" x 12-1/2" x 10"	8" x 1" x 5/8"	1 HP	3450 rpm	54 lbs.
JBG-10A	24-1/2" x 12-1/4" x 13"	10" x 1" x 1"	1-1/2 HP	1725 rpm	110 lbs.

## Abrasive Belts - Aluminum Oxide



Size	Grit	Part No.
3/8" x 13"	40	61122
	60	61124
	80	61125
	100	61126
	120	61127

Size	Grit	Part No.
3/4" x 20-1/2"	40	60129
	60	60131
	80	60132
	100	60133
1-3/16" x 21"	60	TP04084-0
	80	TP04085-0
	100	TP04086-0

Additional sizes, grit and material belts available.

## Cones, Plugs & Cup Wheels

### Type 16 Plug

Part No.	Dia A	Length B	Hole C	RPM
25005	2"	3"	3/8"-24	18100
25006	2"	3"	5/8"-11	18100

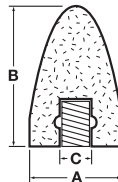

### Type 17 Plug

Part No.	Dia A	Length B	Hole C	RPM
25105	2"	3"	3/8"-24	18100
25106	2"	3"	5/8"-11	18100

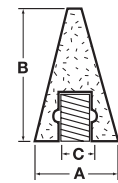

### Type 18 Plug

Part No.	Dia A	Length B	Hole C	RPM
25205	2"	3"	3/8"-24	18100
25206	2"	3"	5/8"-11	18100

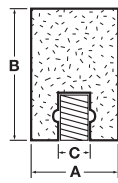

### Type 18R Plug

Part No.	Dia A	Length B	Hole C	RPM
25305	2"	3"	3/8"-24	18100
25306	2"	3"	5/8"-11	18100

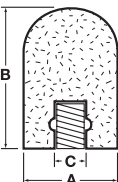

### Type 11 Cup Wheel

Part No.	Dia A	Length B	Hole C	RPM
26010	5"	2"	5/8"-11	7250
26020	6"	2"	5/8"-11	6050

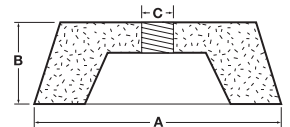

## Grinding & Cut-Off Wheels

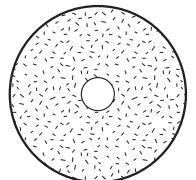
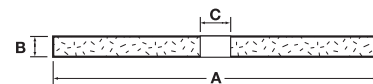

### Grinding Type 1 Flat - with Through Hole

Part No.	Diameter A	Thick B	Hole C	RPM
T1-21238	2"	1/2"	3/8"	25000
T1-2121238	2-1/2"	1/2"	3/8"	22000
T1-45812	4"	5/8"	1/2"	11000
T1-53412	5"	3/4"	1/2"	9000
T1-6158	6"	1"	5/8"	6500
T1-8158	8"	1"	5/8"	7000

### Cut-Off - with Through Hole

Part No.	Diameter A	Thick B	Hole C	RPM
F41638	4"	1/16"	3/8"	19000
F41838		1/8"	3/8"	
F41438		1/4"	3/8"	
F41858		1/8"	5/8"	



**Michigan Pneumatic Model MP-210-CUT**  
**Utility Cut-Off Tool**

Very versatile tool features a metal guard and an OSHA approved safety lever throttle. Cuts through bolts, shackles and steel rods up to 3/4" diameter. Rips through sheet metal with ease. Ideal for auto body and muffler repairs.

**122060** Package of 6 Replacement Wheels

Capacity .....	3"	Weight .....	1.75 lbs.
Free Speed .....	20000 rpm	Air Inlet Thread .....	1/4"
Length .....	7-3/4"	Avg. Air Consumption .....	5 cfm



**Michigan Pneumatic Model MP-3801A-F**  
**Utility Cut-Off Tool**

Heavy-duty shear and grinder in one. Cuts through muffler clamps, hangers, sheet metal and steel rods up to 3/4" thick with ease. Great for auto body repairs. **IMPORT MODEL MP-3801-ST available.**

**122060** Package of 6 Replacement Wheels

Capacity .....	3"	Weight .....	1.75 lbs.
Free Speed .....	20000 rpm	Air Inlet Thread .....	1/4"
Length .....	7"	Avg. Air Consumption .....	5 cfm

3-1/4"



**Diabrade Model 80-4HD**  
**4" Heavy-Duty Fiberglass Trimmer**

Compact, precision saw for the glass-reinforced plastic industry. Fast, powerful cutting with effective dust extraction. Exhaust air is directed away from the operator.

- 72C4B4** Continuous Rim Blade
- 72S4B4** Side Spoke Blade
- 72G4B4** Slotted Blade

Blade Diameter .....	4"	Length .....	11"
Depth of Cut .....	29/32"	Weight .....	4.5 lbs.
Free Speed .....	12000 rpm	Air Inlet Thread .....	1/4"
Maximum HP .....	1.00	Avg. Air Consumption .....	24 cfm

3-1/4"



**Diabrade Model 80-5HD**  
**5" Heavy-Duty Fiberglass Trimmer**

Ideal saw for the glass-reinforced plastic industry. Dust extraction cowl directs exhaust away from the operator.

- 72C5B4** Continuous Rim Blade
- 72S5B4** Side Spoke Blade
- 72G5B4** Slotted Blade

Blade Diameter .....	5"	Length .....	11-1/2"
Depth of Cut .....	1-13/32"	Weight .....	5 lbs.
Free Speed .....	12000 rpm	Air Inlet Thread .....	1/4"
Maximum HP .....	1.00	Avg. Air Consumption .....	24 cfm

4-3/16"



**Diabrade Model 80-7HD15**  
**7" Heavy-Duty Fiberglass Trimmer**

Heavy duty trimmer designed for the glass-reinforced plastic industry. Powerful 1.5HP motor allows for fast precision cutting. Dust extraction cowl directs exhaust away from the operator.

- 72GS7B868** Gulletted Side Spoke Blade

Blade Diameter .....	7"	Length .....	13-3/4"
Depth of Cut .....	2"	Weight .....	11.75 lbs.
Free Speed .....	7100 rpm	Air Inlet Thread .....	3/8"
Maximum HP .....	1.50	Avg. Air Consumption .....	42 cfm



Blade not included.

## Michigan Pneumatic Model MP-SG0826

### Circular Saw

General purpose saw featuring a swiveling saw rest for angled cuts.

Blade Diameter.....	7-1/4"	Length.....	11-1/2"
Max. Depth of Cut.....	2-23/64"	Weight.....	10.5 lbs.
Free Speed.....	4500 rpm	Air Inlet Thread.....	1/4"
Maximum HP.....	1.50	Avg. Air Consumption.....	8 cfm



2-1/4"



Wheel not included

## Nippon Pneumatic Model DAC-11

### Rotary Cutter

**Features front exhaust.** Ideal for automotive repair, sheet metal and fiberglass industries. Features diamond tipped cutting blade. Great for panel sawing and trimming. Adjustable cutting depth allows for maximum versatility. Extra diamond blades available.

**D32000K390** Diamond Cutter Blade

Blade Diameter.....	2-1/8"	Length.....	11-3/4"
Depth of Cut.....	3/8"	Weight.....	3.7 lbs.
Free Speed.....	13000 rpm	Air Inlet Thread.....	1/4"
Maximum HP.....	1.00	Avg. Air Consumption.....	16 cfm



2-3/4"



Wheel not included

## Michigan Pneumatic Model MP-9314A-DD

### Rotary Cutter

**Features rear exhaust.** Panel saw features left or right head cut. Ideal for sheet metal and fiberglass industries. Useful for reaching into narrow corners and holes.

**F41638** 1/16" Replacement Wheel

**F41838** 1/8" Replacement Wheel

Blade Diameter.....	4"	Length.....	13-1/4"
Depth of Cut.....	1-1/4"	Weight.....	2.9 lbs.
Free Speed.....	15000 rpm	Air Inlet Thread.....	1/4"
Maximum HP.....	1.00	Avg. Air Consumption.....	16 cfm



1-1/2"



Wheel not included

## Michigan Pneumatic Model MP-9315CR-DD

### Rotary Cutter

**Features rear exhaust.** Designed to reach into narrow corners and holes. Guard rotates to allow for left or right cuts.

**F41638** 1/16" Replacement Wheel

**F41838** 1/8" Replacement Wheel

Blade Diameter.....	4"	Length.....	15-7/8"
Depth of Cut.....	1-1/4"	Weight.....	3.1 lbs.
Free Speed.....	15000 rpm	Air Inlet Thread.....	1/4"
Maximum HP.....	1.00	Avg. Air Consumption.....	16 cfm



1-1/2"



Wheel not included

## Michigan Pneumatic Model MP-9315U-DD

### Rotary Cutter - Electric

**Features rear exhaust.** Same features as our air rotary cutter. Ideal for automotive repair & sheet metal shops.

**F41638** 1/16" Replacement Wheel

**F41838** 1/8" Replacement Wheel

Blade Diameter.....	4"	Length.....	18-1/2"
Depth of Cut.....	1-1/4"	Weight.....	4.4 lbs.
Free Speed.....	15000 rpm	Power.....	110V
Maximum HP.....	1.00		

# Air Nipper/Trimmer



Powerful, lightweight trimmers designed for a variety of applications, including pressing, riveting, bending and plate cutting. Ideal for cutting copper wire and soft materials. Larger units are perfect for cutting plastics, stainless steel and piano wire. **Optional blades available.**

Model No.	Copper Wire Capacity	Steel Wire Capacity	Length	Weight	Diameter	Air Inlet
MP-AN16	1/16"	-	5-29/32"	7 oz.	1-3/8"	1/8" FPT
MP-MR3	1/32"	1/64"	4-13/32"	3.2 oz.	25/32"	1/4" MPT
MP-MR20	7/64"	5/64"	5-19/32"	14 oz.	1-3/4"	1/4" MPT
MP-MR30-CR8P	9/64"	1/8"	7"	1.50 lbs.	2-1/4"	1/4" MPT
MP-MP35A-CR8P	3/16"	5/32"	12"	2.63 lbs.	2-1/4"	1/4" MPT
MP-MR50	15/64"	3/16"	9-19/64"	3.33 lbs.	3"	1/4" MPT
MP-MP55A-P120	17/64"	15/64"	14-41/64"	6.40 lbs.	3"	1/4" MPT

## Optional Blades for Air Nipper/Wire Trimmer

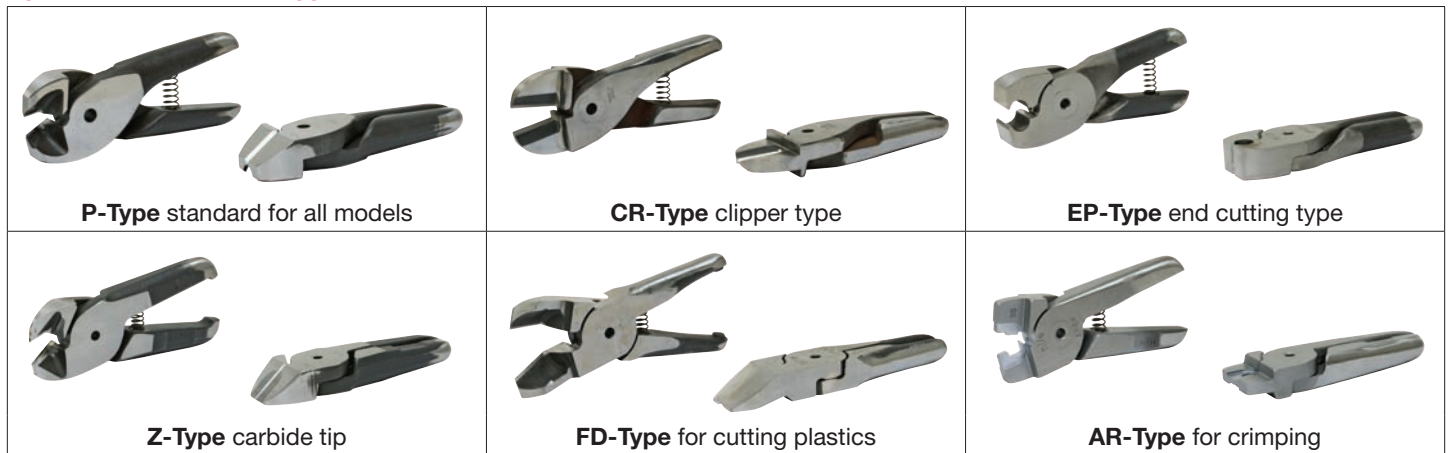

### Used in the MP-MR20 Nipper

Part No.	Description
CR6	Clipper Blade
P6	Standard Blade

### Used in the MP-MR50/MP-MP55A Nipper

Part No.	Description
CR120	Clipper Blade
P120	Standard Blade

### Used in the MP-MR30 Nipper

Part No.	Description
AR8P	Crimping Blade
CR8P	Clipper Blade
EP10P	End Cutting Blade
FD9P	Plastic Cutting Blade
P8P	Standard Blade
Z8P	Carbide Tip Blade

### Used in the MP-MR35A Nipper

Part No.	Description
AR8P	Crimping Blade
CR8P	Clipper Blade
EP10P	End Cutting Blade
FD9P	Plastic Cutting Blade
P8P	Standard Blade
Z8P	Carbide Tip Blade

# Reciprocating Saws & Files



MP-129TW-ST



SSW-110



MP-4132K-DD

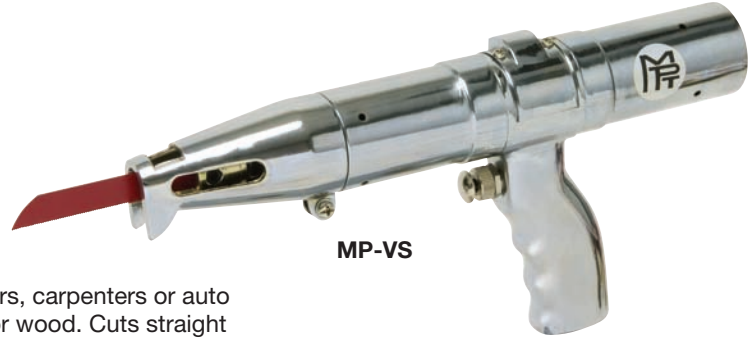

MP-VS

One hand operation makes difficult jobs simple. Ideal for plumbers, carpenters or auto repair technicians for sawing or filing iron, steel, copper, plastic or wood. Cuts straight and curved surfaces in confined places.

Model No.	Strokes Per Minute	Stroke	Blade Type	Length	Weight	Air Inlet	Avg. Air Consumption
MP-129TW-ST	10000	3/8"	Standard/Scroll	9-1/4"	1.38 lbs.	1/4"	5 cfm
MP-4132K-DD	9000	3/8"	Standard/Scroll	9-3/8"	1.25 lbs.		9 cfm
SSW-110	7000	3/8"	Nitto Style	8-1/2"	1.45 lbs.		9 cfm
MP-VS	2200	1-1/4"	Standard/Scroll	11-3/8"	3.80 lbs.		5 cfm

## Hi-Speed Saw Blades

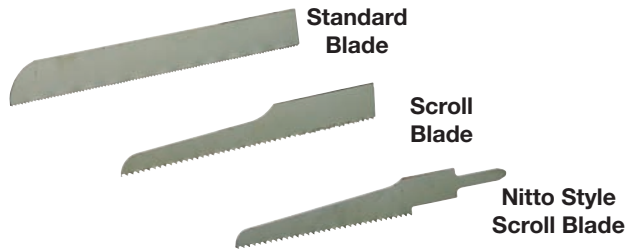

Minimum quantities of 10 each. Bench files also available.

Standard Blade		Scroll Blade		Nitto Style Scroll Blade	
Part No.	No. of Teeth	Part No.	No. of Teeth	Part No.	No. of Teeth
12110	10	12510	10	-	-
12114	14	12514	14	13014	14
12118	18	12518	18	13018	18
12124	24	12524	24	13024	24
12132	32	12532	32	13032	32



SH-100A



ASH-800

Small, lightweight "SuperHand" performs with the power and efficiency of much larger tools. Ideal for filing, descaling, grinding, chamfering and polishing. Great for curves. **Extra files and pad assembly available.**

- TA9A222-0** Rat Tail File (set of 5)
- TA9A223-0** Triangular Taper File (set of 5)
- TA9A224-0** Half Round File (set of 5)
- TA9A225-0** Flat Bastard File (set of 5)

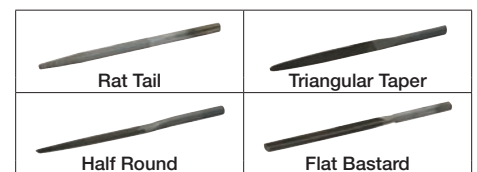

Model No.	Speed	Stroke	Shank Diameter	Length	Weight	Avg. Air Consumption
MP-1000A-ST	3700 B/minute	23/64"	1/4"	6-7/8"	2.50 lbs.	8.5 cfm
SH-100A	3700 B/minute	23/64"	1/4"	6-7/8"	2.50 lbs.	8.5 cfm
ASH-800	6500 B/minute	5/16"	7/32"	7-1/2"	1.15 lbs.	8.1 cfm

Equipped with 4 different files for all types of work.

# Reciprocating Saws & Accessories



## Model MP-5-1212-0050 Hacksaw



Designed for service in refineries, chemical plants, utilities, pipelines and heavy industry. Ideal for cutting pipes, tanks and structural steel. Pipes up to 24" diameter can be cut in a single pass. Optional clamps for precise cuts available.

Strokes Per Minute.....	330	Rec'd Hose Size .....	1/2"
Length of Stroke .....	2-3/8"	Weight .....	15.4 lbs.
Capacity .....	24"	Air Inlet Thread .....	3/4"
Maximum HP .....	1.5	Avg. Air Consumption .....	51 cfm

## MP-5-1212-0050 Accessories



512079910 Pipe Clamp



512078970 Profile Clamp



CCSG3 4-in-1 Clamp



512029960 Pipe Clamp

Part No.	Description
512019010	17-3/8" Extension Chain
512019030	39-3/8" Extension Chain
512079970	Saw Blade Guide (up to 13" capacity)
512078910	Saw Blade Guide (up to 21" capacity)
512079910	Pipe Clamp (up to 6" capacity)
512029960	Pipe Clamp (up to 12-3/4" capacity, up to 24" dia. with extension chain)
512078970	Profile Clamp (up to 21-5/8" x 11-3/8" capacity)
CCSG3	4-in-1 Clamp

Part No.	Description
10907	16" Saw Blade, 14 TPI
Z22-6-HSS	12" Saw Blade, 16 TPI (50 per box)
Z22-7-HSS	16" Saw Blade, 16 TPI (50 per box)
Z22-29-HSS	16" Saw Blade, 8 TPI (50 per box)
Z22-30-HSS	21" Saw Blade, 12 TPI (25 per box)
Z22-37-HSS	37" Saw Blade, 12 TPI (25 per box)
Z22-72-HSS	20" Saw Blade, 14 TPI (20 per box)

## MP-5-1217-0020 Reciprocating Saw



The perfect tool for sawing up to 4" steel pipe or up to 6" plastic pipe. Ideal for assembly, demolition, pipe repair and pallets. Plunge-in sawing for plastic pipe up to 63" in diameter. Optional clamps available.

Strokes Per Minute.....	1800	Rec'd Hose Size .....	1/2"
Length of Stroke .....	1-1/8"	Weight .....	9 lbs.
Capacity .....	4"	Air Inlet Thread .....	1/2"
Maximum HP .....	1.3	Avg. Air Consumption .....	46 cfm

## MP-5-1217-0020 Accessories



563100 Clamp-On Vise



251259 Pipe Clamp

Part No.	Description
252329	6" Blade, 8 TPI, 5 blades per pack
251620	8" Blade, 8 TPI, 5 blades per pack
251259	Pipe Clamp (1/2" - 6" capacity, up to 8" plastic)
259983	Clamp-On Vise (1/2" - 2" capacity)
563100	Clamp-On Vise (2-1/2" - 4" capacity)





## Michigan Pneumatic Model MP-51005

### Utility Chain Saw

Lightweight, general utility pneumatic chain saw cuts wood and plastic fast. Ideal for applications in chemical plants, utilities, mines and construction.

**51005-7110** 10" Guide Bar  
**51005-9910** 10" Chain

Blade Length .....	10"	Length .....	20-1/4"
Free Speed .....	228 sfpm	Weight .....	4.4 lbs.
Maximum HP .....	1.20	Air Inlet Thread .....	1/4"
Rec'd Hose Size .....	3/8"	Avg. Air Consumption .....	30 cfm



## Michigan Pneumatic Model MP-51007-25

### Utility Chain Saw

Ideal for cutting wood and plastic in polyethylene plants, petro-chemical industries, utilities, underground mines and marine industries. **Model MP-51008-25 for underwater applications.**

**51007-7140** 25" Guide Bar      **51007-9940** 25" Chain

Blade Length .....	25"	Length .....	41"
Free Speed .....	1900 sfpm	Weight .....	20 lbs.
Maximum HP .....	4.00	Air Inlet Thread .....	3/4"
Rec'd Hose Size .....	3/4"	Avg. Air Consumption .....	92 cfm



## Michigan Pneumatic Model MP-71773-14

### Concrete Chain Saw

Designed to cut through reinforced concrete, stone, concrete pipe and brick. Features die-cast aluminum body for use in harsh environments and a built-in wall-walker for leverage. **Model MP-71773-10 with 10" blade length available.**

**71773-2176** 14" Guide Bar      **70552** Speed Hook® Kit  
**71773-4723** 14" Chain

Blade Length .....	14"	Length .....	35-1/4"
Free Speed .....	4900 sfpm	Weight .....	34 lbs.
Maximum HP .....	6.50	Air Inlet Thread .....	3/4"
Rec'd Hose Size .....	3/4"	Avg. Air Consumption .....	124 cfm



## Michigan Pneumatic Model MP-5631-475

### Portable Band Saw

Safe in hazardous areas. Fast, free-hand cutting of pipe and other profiles. Quickly cuts steel, angle iron, stainless steel and hard metals with tough M42 saw blades. **Electric Model MP-5641-475 available.**

**925060030** 10-14 Variable TPI Bandsaw Blade (each)  
**560039000** Clamp-On Vise

Max. Width of Cut.....	4-1/2"	Length .....	21-1/2"
Max. Depth of Cut .....	4-3/4"	Weight .....	14 lbs.
Free Speed .....	220 sfpm	Air Inlet Thread .....	1/4"
Maximum HP .....	0.75	Avg. Air Consumption .....	20 cfm



## Michigan Pneumatic Model MP-5631-725

### Portable Band Saw

Safe in hazardous areas. Fast, free-hand cutting of pipe and other profiles. Quickly cuts steel, angle iron, stainless steel and hard metals with tough M42 saw blades. **Electric Model MP-5671-725 available.**

**925060230** 10-14 Variable TPI Bandsaw Blade (each)  
**560319400** Clamp-On Vise

Max. Width of Cut.....	7"	Length .....	28-3/4"
Max. Depth of Cut .....	7"	Weight .....	28 lbs.
Free Speed .....	295 sfpm	Air Inlet Thread .....	1/4"
Maximum HP .....	1.30	Avg. Air Consumption .....	43 cfm



## Kett Model P-1040 Pneumatic Metal Shears

Features a variable speed motor for a smooth, well-balanced grip. Double cut shear easily cuts through 14 gauge mild steel and stainless to 18 gauge without the need to file or deburr. Shears aluminum, tin, steel and plastic with ease. **Import Model MP-204-S 18 gauge shear available.**

<b>40-20</b>	Shear Head	<b>40-21</b>	Center Blade
<b>60-22L</b>	Side Knife Left	<b>60-22R</b>	Side Knife Right

Capacity.....	14 Gauge Mild Steel	Length.....	10"
Cutting Speed.....	180"/min.	Weight.....	3 lbs.
Maximum Speed .....	2500 rpm	Air Inlet Thread .....	1/4"



## Kett Model P-500 Pneumatic Metal Shears

Features double-cutting action to cleanly cut 18 gauge and lighter sheet metal without distortion. A 7/32" waste curl leaves both sides of the cut straight with no need to file or deburr. Variable speed trigger provides speed control. Ideal for the tinner, roofer and auto body shop.

<b>60-20</b>	Shear Head	<b>60-21</b>	Center Blade
<b>60-22L</b>	Side Knife Left	<b>60-22R</b>	Side Knife Right

Capacity.....	18 Gauge Mild Steel	Length.....	11"
Cutting Speed.....	180"/min.	Weight.....	3 lbs.
Maximum Speed .....	2200 rpm	Air Inlet Thread .....	1/4"



## Kett Model P-540 Pneumatic Metal Shears

For heavier duty applications than the P-500, cutting up to 14 gauge cold-rolled steel. Variable speed trigger lets operator make smooth, easy starting cuts even in most grades of stainless steel up to 16 gauge. Great time saver in any construction company, sheet metal or sign shop.

<b>40-20</b>	Shear Head	<b>40-21</b>	Center Blade
<b>60-22L</b>	Side Knife Left	<b>60-22R</b>	Side Knife Right

Capacity.....	14 Gauge Mild Steel	Length.....	11"
Cutting Speed.....	150"/min.	Weight.....	4 lbs.
Maximum Speed .....	2200 rpm	Air Inlet Thread .....	1/4"



## Kett Model KD-200 Electric Metal Shears - 120 Volt

Double-cut shears feed quickly and quietly without warping or bending. Easily follows a scribed line. Edges are not hardened or burred to get maximum use of a sheet. Swiping action of blades seals the edge of coated metals. Cut sheet metal in straight or contoured lines and plastic or formica up to 3/32" thick.

<b>60-20</b>	Shear Head	<b>60-21</b>	Center Blade
<b>60-22L</b>	Side Knife Left	<b>60-22R</b>	Side Knife Right

Capacity.....	18 Gauge Mild Steel	Length.....	13-1/2"
Cutting Speed.....	180"/min.	Weight.....	4 lbs.
Maximum Speed .....	2500 rpm	Motor.....	5.0 Amps



## Kett Model KD-440 Electric Metal Shears - 120 Volt

Lightweight pistol-grip shear cuts 14 gauge mild steel and stainless up to 16 gauge. Double-insulated, variable-speed motor cuts at over 150 inches per minute, leaving a clean, flat sheet, ready to fabricate. Distortions are absorbed in an easily disposed waste curl, leaving the sheet cool and free of burn, chips or burrs.

<b>40-20</b>	Shear Head	<b>40-21</b>	Center Blade
<b>60-22L</b>	Side Knife Left	<b>60-22R</b>	Side Knife Right

Capacity.....	14 Gauge Mild Steel	Length.....	13-1/2"
Cutting Speed.....	150"/min.	Weight.....	5 lbs.
Maximum Speed .....	2500 rpm	Motor.....	5 Amps



**Kett Model P-1080**  
**Pneumatic Scissor Shears**

Features a new, straight-handled body design for improved control and maneuverability. Easily cuts through pliable materials such as carpet, foam rubber, linoleum and vinyl. Equipped with variable speed motor for fast, accurate work. Truly compact and portable.

<b>80-20</b>	Scissor Head	<b>80-21</b>	Scissor Blade
<b>80-22</b>	Stationary Blade		

Capacity.....	Pliable Materials	Length.....	12"
Maximum Speed.....	2500 rpm	Weight.....	3 lbs.
Avg. Air Consumption:.....	4 cfm	Air Inlet Thread.....	1/4"



**Kett Model P-580**  
**Pneumatic Scissor Shears**

Cuts a wide range of pliable sheet materials, including carpet and carpet underlay, foam rubber, linoleum, vinyl and woven wood fabric. Large rabbit ear blades funnel thick, soft materials into the scissor jaws without fouling or gouging. Handles heavy foil, light insulated wire, hardware cloth and mesh screening.

<b>80-20</b>	Scissor Head	<b>80-21</b>	Scissor Blade
<b>80-22</b>	Stationary Blade		

Capacity.....	Pliable Materials	Length.....	12-1/2"
Maximum Speed.....	2200 rpm	Weight.....	3 lbs.
Avg. Air Consumption:.....	4 cfm	Air Inlet Thread.....	1/4"



**Kett Model P-541**  
**Pneumatic Scissor Shears**

Quickly cuts through plastics, wire mesh and rubber with a clean scissors action. When cutting thin coated metals, the swiping cut seals edges to prevent rust and corrosion. Variable speed motor lets operator set the speed of the shears to the work.

<b>41-20</b>	Scissor Head	<b>41-21</b>	Scissor Blade
<b>41-22</b>	Stationary Blade		

Capacity.....	24 Gauge Mild Steel	Length.....	12-1/2"
	18 Gauge Wire Mesh	Weight.....	5 lbs.
Maximum Speed.....	2200 rpm	Air Inlet Thread.....	1/4"



**Kett Model KD-280**  
**Electric Scissor Shears - 120 Volt**

Large rabbit ear blades funnel thick, soft materials into the scissor jaws for a clean, flowing cut. Ideal for cutting pliable materials such as vinyl, woven wood, chipboard, foam rubber and linoleum. Also cuts heavy foil, light insulated wire, hardware cloth and light mesh screening. Features stationary bottom blade and single speed motor.

<b>80-20</b>	Scissor Head	<b>80-21</b>	Scissor Blade
<b>80-22</b>	Stationary Blade		

Capacity.....	Pliable Materials	Length.....	15-1/2"
	Light Wire	Weight.....	4 lbs.
Maximum Speed.....	2500 rpm	Motor.....	5 Amps



**Kett Model KD-441**  
**Electric Scissor Shears - 120 Volt**

Quickly cuts through plastics, wire mesh and rubber with a clean scissors action. When cutting thin coated metals, the swiping cut seals edges to prevent rust and corrosion. Variable speed motor lets operator set the speed of the shears to the work.

<b>41-20</b>	Scissor Head	<b>41-21</b>	Scissor Blade
<b>41-22</b>	Stationary Blade		

Capacity.....	24 Gauge Mild Steel	Length.....	15-1/2"
	18 Gauge Wire Mesh	Weight.....	5 lbs.
Maximum Speed.....	2500 rpm	Motor.....	5 Amps

# Portable Nibblers & Bevelers



Air operated portable nibblers are used where safety is a prime factor, such as oil refineries, chemical plants and other areas where electricity cannot be used due to hazardous conditions. These precisely engineered nibblers cut almost any metal faster, with increased operator

efficiency. Designed to produce a clean cut without distortion, leaving an edge requiring only minimal deburring or grinding. These nibblers offer the same metal cutting advantages as electric models. **One year warranty.**



**521536** Cutter  
**521539** Cutter Die

## Michigan Pneumatic Model MP-5215-ST

### Nibbler - Air

Ideal for cutting up to 18 gauge sheet metal in any configuration. Provides a clean, smooth, accurate cut without distortion. Equipped with heavy-duty die cutter and holder. Durable and lightweight for easy handling.

Capacity.....	3/64" Steel	Weight.....	1.875 lbs.
	5/64" Aluminum	Rec'd Hose Size .....	3/8"
Free Speed .....	4300 rpm	Air Inlet.....	1/4"
Length .....	7"	Avg. Air Consumption .....	4 cfm



**21340** Punch  
**21341** Die

## Michigan Pneumatic Model MP-711F-ST

### Nibbler - Air

Cuts sheet metal in any configuration and holes as small as 1" in diameter without distortion. Great for use with templates. Equipped with adjustable die guide for easy cutting.

Capacity.....	18 Gauge Steel	Weight.....	2 lbs.
Width of Cut.....	7/32"	Rec'd Hose Size .....	3/8"
Strokes Per Minute.....	2600	Air Inlet.....	1/4"
Length .....	7"	Avg. Air Consumption .....	4 cfm



**TV7A019-0** Straight Tip (2 pc)  
**TV7A020-0** 1/16" radius (2 pc)  
**TV7A021-0** 1/8" radius (2 pc)  
**TV7A022-0** 5/32" radius (2 pc)

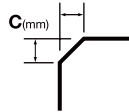

## Nitto Kohki Model AMB-0307

### Mini Beveler - Air

Small beveler for big jobs, such as speedy pipe beveling. Ideal for stainless steel up to 3C. Compact, lightweight tool is ideal for on-site beveling jobs. Pipe outer diameter chamfering kit supplied with tool.

Capacity.....	9/32" C Mild Steel	Weight.....	6.25 lbs.
	1/8" C Stainless	Rec'd Hose Size .....	3/8"
Free Speed .....	13000 rpm	Air Inlet.....	1/4"
Cutting Diameter .....	1-1/8"	Avg. Air Consumption .....	31.8 cfm



**1439361** Punch  
**1439360** Carrier with Integrated Die

## Trumpf Model PN-130-0

### Profile Nibbler - Electric

- Cuts welded seams and uneven material.
- Extremely maneuverable.
- May be guided in any direction.
- Suitable for interior cutouts.

Maximum Material Thickness.....	0.051"
Cutting Speed .....	10 ft./min.
Smallest Radius.....	0.984"
Motor Rating.....	350 W
Weight .....	3.1 lbs.



**0088503** Cutter  
**0089335** Cutter (HSS)  
**0005014** Cutter (Aluminum)  
**0110399** Cutter (Heavy Duty)

## Trumpf Model TKF-1500-1-PLUS

### Beveler - Air

- Unsurpassed beveling speed.
- 2-speed motor for stainless steel
- Prepares plate and pipe for welding.
- Easily adjustable.

Maximum Material Thickness.....	1-1/2"
Cutting Speed .....	4-6 ft./min.
Bevel Angles.....	20°-45°
Smallest Inner Radius.....	2-11/64"
Weight .....	43 lbs.
Rec'd Hose Size.....	5/8"
Air Inlet .....	1/2" MPT
Avg. Air Consumption .....	100 cfm

TRUMPF



## Trumpf Model C160-5-PLUS

### Double Cut Shears

Mild Steel.....(0.063") .16 ga.  
 Stainless.....(0.047") .18 ga.  
 Aluminum.....(0.078")  
 Cutting Speed.....4-6 ft./min.  
 Minimum Radius.....3.5"  
 Weight.....3.1 lbs.  
 Rec'd Hose Size.....3/8"  
 Air Inlet.....1/4" MPT  
 Avg. Air Consumption.....13 cfm

#### Replacement Parts:

Cutter (Straight Moving)  
 up to 0.040" **0143432**  
 0.040"-0.063" **0143463**  
 Cutter (Curves) to 0.40" **0143434**  
 Cutter (HSS & Spiral  
 Duct) up to .040" **0934055**  
 Cutter Set (Fixed) **0913520**

ELECTRIC MODEL C160-2-PLUS available.

TRUMPF



## Trumpf Model S160-9

### Light-Duty Shears

Mild Steel.....(0.063") 16 ga.  
 Stainless.....(0.040") 19 ga.  
 Aluminum.....(0.075") 14 ga.  
 Cutting Speed.....24-36 ft./min.  
 Minimum Radius.....0.590"  
 Weight.....3.5 lbs.  
 Rec'd Hose Size.....3/8"  
 Air Inlet.....1/4" MPT  
 Avg. Air Consumption.....13 cfm

#### Replacement Parts:

Cutter (Upper or Lower) **0044502**

ELECTRIC MODEL S160-6 available.

TRUMPF



## Trumpf Model S250-7

### Medium-Duty Shears

Mild Steel.....(0.105") 12 ga.  
 Stainless.....(0.063") 16 ga.  
 Aluminum.....(0.120") 11 ga.  
 Cutting Speed.....13-23 ft./min.  
 Minimum Radius.....0.787"  
 Weight.....5 lbs.  
 Rec'd Hose Size.....3/8"  
 Air Inlet.....1/4" MPT  
 Avg. Air Consumption.....13 cfm

#### Replacement Parts:

Cutter (Upper or Lower) **0003946**

ELECTRIC MODEL S250-6 available.

TRUMPF



## Trumpf Model S350-3

### Heavy-Duty Shears

Mild Steel.....(0.138") 10 ga.  
 Stainless.....(0.075") 14 ga.  
 Aluminum.....(0.157") 9 ga.  
 Cutting Speed.....13-20 ft./min.  
 Minimum Radius.....1"  
 Weight.....14 lbs.  
 Rec'd Hose Size.....1/2"  
 Air Inlet.....1/2" MPT  
 Avg. Air Consumption.....54 cfm

#### Replacement Parts:

Cutter (mild steel), set  
 of 2 with screws **0140451**  
 Cutter (stainless), set  
 of 2 with screws **0140452**

ELECTRIC MODEL S350-4 available.

# Portable Electric Nibblers



120 volt portable electric nibblers are ideal for burr-free metal cutting of straight or curved lines and notching with no distortion of the metal sheet or plate. Tools are perfectly balanced for cutting and operator efficiency.

Weighing from 4 to 32 pounds, five different models offer capacities from 14 gauge to 3/8" mild steel. Also available in 220 volt. **One year factory warranty.**

**TRUMPF**



## Trumpf Model N200-4 Light-Duty Cutting

- Unlimited maneuverability.
- Can be used on corrugated.

Mild Steel.....	(0.079")	14 ga.
Stainless.....	(0.040")	19 ga.
Aluminum.....	(0.100")	12 ga.
Cutting Speed.....	4 ft./min.	
Minimum Radius.....	0.160"	
Weight.....	4.6 lbs.	

### Replacement Parts:

Punch	<b>0944506</b>
Die (w/ pin & cover)	<b>0980335</b>

**TRUMPF**



## Trumpf Model N350-4 Medium-Duty Cutting

- Compact, easy handling.
- Tool-free die and punch changing.

Mild Steel.....	(0.135")	10 ga.
Stainless.....	(0.090")	15 ga.
Aluminum.....	(0.135")	10 ga.
Cutting Speed.....	4 ft./min.	
Minimum Radius.....	0.280"	
Weight.....	7.5 lbs.	

### Replacement Parts:

Punch	<b>0093538</b>
Punch (HSS)	<b>0103545</b>
Die	<b>0093536</b>
Die (HSS)	<b>0103546</b>

**TRUMPF**



## Trumpf Model N500-8 Heavy-Duty Cutting

- Very fast cutting speed.
- Tool-free punch changing.

Mild Steel.....	(0.197")	6 ga.
Stainless.....	(0.135")	10 ga.
Aluminum.....	0.276"	
Cutting Speed.....	4.5 ft./min.	
Minimum Radius.....	3.20"	
Weight.....	8.5 lbs.	

### Replacement Parts:

5/P5 Punch	<b>1451224</b>
Die 5 (0.120" to 0.197")	<b>0975464</b>
Die P5 (90° bends & up to 0.276" alum.)	<b>0975462</b>
2/3 Punch	<b>1453187</b>
Die 3 (0.075" to 0.126")	<b>0975466</b>
Die 2 (0.048" to 0.078")	<b>0975468</b>
Punch Guide	<b>0975460</b>

**TRUMPF**



## Trumpf Model N700-2 Extra Heavy-Duty Cutting

- Light weight and maneuverable for any application.
- Very fast cutting speed.

Mild Steel.....	0.276"	
Stainless.....	(0.197")	6 ga.
Aluminum.....	0.394"	
Cutting Speed.....	5 ft./min.	
Minimum Radius.....	5.50"	
Weight.....	18.3 lbs.	

### Replacement Parts:

Punch	<b>0104589</b>
Punch (HSS)	<b>0104590</b>
Die (0.118" to 0.197")	<b>0098723</b>
Die (0.197" to 0.276")	<b>0098722</b>
Die (90° bends & 0.394" aluminum)	<b>0098721</b>
Wear Plate	<b>0119173</b>
Punch Guide	<b>1274571</b>

**TRUMPF**



## Trumpf Model N1000-0 Super Heavy-Duty Cutting

- Easily sharpened punches and dies.
- 2-speed motor for optimum performance in any application.

Mild Steel.....	0.375"	
Stainless.....	0.276"	
Aluminum.....	0.500"	
Cutting Speed.....	Gear 1: 3.25 ft./min.	
	Gear 2: 5.25 ft./min.	
Minimum Radius.....	16"	
Weight.....	32 lbs.	

### Replacement Parts:

Punch	<b>0112900</b>
Punch (HSS)	<b>0120344</b>
Die (0.197" to 0.276")	<b>0112899</b>
Die (0.276" to 0.394")	<b>0112898</b>
Die (90° bends & 0.472" aluminum)	<b>0112897</b>
Wear Plate	<b>0112922</b>
Punch Guide	<b>0112901</b>

Air operated portable nibblers are used where safety is a prime factor, such as oil refineries, chemical plants and other areas where electricity cannot be used because of hazardous atmospheres. These nibblers offer the

same metal-cutting advantages as the electric models. Weighing from 3.5 to 32 pounds, five different models offer capacities from 14 gauge to 3/8" mild steel. **One year factory warranty.**

**TRUMPF**



**Trumf Model N200-7 Light-Duty Cutting**

- Unlimited maneuverability.
- Can be used on corrugated.

Mild Steel.....	(0.079") 14 ga.
Stainless .....	(0.040") 19 ga.
Aluminum .....	(0.100") 12 ga.
Cutting Speed .....	4.5 ft./min.
Minimum Radius.....	0.160"
Weight .....	3.5 lbs.
Rec'd Hose Size .....	3/8"
Air Inlet .....	1/4" MPT
Avg. Air Consumption .....	13 cfm

**Replacement Parts:**

Punch	<b>0944506</b>
Die (w/ pin & cover)	<b>0980335</b>

**TRUMPF**



**Trumf Model N350-3 Medium-Duty Cutting**

- Extremely maneuverable.
- Lubricator in handle.

Mild Steel.....	(0.135") 10 ga.
Stainless .....	(0.090") 15 ga.
Aluminum .....	(0.135") 10 ga.
Cutting Speed .....	4 ft./min.
Minimum Radius.....	0.280"
Weight .....	10.5 lbs.
Rec'd Hose Size .....	5/8"
Air Inlet .....	1/2" MPT
Avg. Air Consumption .....	54 cfm

**Replacement Parts:**

Punch	<b>0093538</b>
Punch (HSS)	<b>0103545</b>
Die	<b>0093536</b>
Die (HSS)	<b>0103546</b>

**TRUMPF**



**Trumf Model N500-7 Heavy-Duty Cutting**

- Very fast cutting speed.
- Tool-free punch changing.

Mild Steel.....	(0.197") 6 ga.
Stainless .....	(0.135") 10 ga.
Aluminum .....	0.276"
Cutting Speed .....	4.5 ft./min.
Minimum Radius.....	0.280"
Weight .....	9 lbs.
Rec'd Hose Size .....	5/8"
Air Inlet .....	1/2" MPT
Avg. Air Consumption .....	54 cfm

**Replacement Parts:**

5/P5 Punch	<b>1451224</b>
Die 5 (0.120" to 0.197")	<b>0975464</b>
Die P5 (90° bends & up to 0.276" aluminum)	<b>0975462</b>
2/3 Punch	<b>1453187</b>
Die 3 (0.075" to 0.126")	<b>0975466</b>
Die 2 (0.048" to 0.078")	<b>0975468</b>
Punch Guide	<b>0975460</b>

**TRUMPF**



**Trumf Model N700-1 Extra Heavy-Duty Cutting**

- Very fast cutting speed.
- Light weight and maneuverable for any application.

Mild Steel.....	0.276"
Stainless .....	(0.197") 6 ga.
Aluminum .....	0.394"
Cutting Speed .....	5 ft./min.
Minimum Radius.....	5.50"
Weight .....	27 lbs.
Rec'd Hose Size .....	5/8"
Air Inlet .....	1/2" MPT
Avg. Air Consumption .....	100 cfm

**Replacement Parts:**

Punch	<b>0104589</b>
Punch (HSS)	<b>0104590</b>
Die (0.118" to 0.197")	<b>0098723</b>
Die (0.197" to 0.276")	<b>0098722</b>
Die (90° bends & 0.394" aluminum)	<b>0098721</b>
Wear Plate	<b>0119173</b>
Punch Guide	<b>1274571</b>

**TRUMPF**



**Trumf Model N1000-1 Super Heavy-Duty Cutting**

- Easily resharpened punches and dies.
- Adjustable stripper for variable material thickness.

Mild Steel.....	0.375"
Stainless .....	0.276"
Aluminum .....	0.500"
Cutting Speed .....	Gear 1: 3.25 ft./min.
	Gear 2: 5.25 ft./min.
Minimum Radius.....	16"
Weight .....	32 lbs.
Rec'd Hose Size .....	5/8"
Air Inlet .....	1/2" MPT
Avg. Air Consumption .....	100 cfm

**Replacement Parts:**

Punch	<b>0112900</b>
Punch (HSS)	<b>0120344</b>
Die (0.197" to 0.276")	<b>0112899</b>
Die (0.276" to 0.394")	<b>0112898</b>
Die (90° bends & 0.472" aluminum)	<b>0112897</b>
Wear Plate	<b>0112922</b>
Punch Guide	<b>0112901</b>

# POP® Blind Riveters



## POP® Model PRG510A Pneumatic Riveter

Low cost riveter designed for high speed production, trouble free riveting and easy maintenance. **See page 89 for MCS retrofit kit.** Model PRG510A-Plus includes a 6 ft. hose, additional nosepieces and an adjusting screw. Model MCS510A with Mandrel Collection System (MCS) also available.

- PRG402-8A Jaw Set
- PRG520-33 Jaw Pusher
- PRG510-130 Jaw Lube

- Nosepieces:**
- PRN414 1/8" Open End
  - PRN514 5/32" Open End
  - PRN614 3/16" Open End



Weight.....4 lbs.  
Stroke.....5/8"  
Pulling Force.....1000 lbs.  
Pressure.....85 psi  
Air Consumption:.....0.007 cf/rivet

Material		Rivet Diameter					
Rivet	Mandrel	3/32"	7/64"	1/8"	5/32"	3/16"	1/4"
Alum.	Alum.	•		•/○	•/○	•/○	
Alum.	Steel	•		•/○	•	•/†	
Steel	Steel	•		•	•		
Monel	Steel		•	•			
Stainless	Steel			•			
Stainless	Stainless			•/○	•/○		

• - Open end rivet ○ - Closed end rivet † - Except Multi-Grip

## POP® Model PRG511A Extended Nose Riveter

Low cost riveter designed for high speed production, trouble free riveting and easy maintenance. **See page 89 for MCS retrofit kit.** Model MCS511A with Mandrel Collection System (MCS) also available.

- PRG402-8A Jaw Set
- PRG520-33 Jaw Pusher
- PRG510-130 Jaw Lube

- Nosepieces:**
- PRN414 1/8" Open End
  - PRN514 5/32" Open End
  - PRN614 3/16" Open End



Weight.....4 lbs.  
Stroke.....5/8"  
Pulling Force.....1000 lbs.  
Pressure.....85 psi  
Air Consumption:.....0.007 cf/rivet

Material		Rivet Diameter					
Rivet	Mandrel	3/32"	7/64"	1/8"	5/32"	3/16"	1/4"
Alum.	Alum.	•		•/○	•/○	•/○	
Alum.	Steel	•		•/○	•	•	
Steel	Steel	•		•	•		
Monel	Steel		•	•			
Stainless	Steel			•			
Stainless	Stainless			•/○	•/○		

• - Open end rivet ○ - Closed end rivet

## POP® Model PRG540 Air/Hydraulic Riveter

Ideal for high production assembly. World's most widely used blind riveter, designed to increase productivity. Sets the entire range of rivets. Sets high strength structural 1/4" rivets and 1/4" stainless Ultra-Grip rivets. **See page 87 for MCS retrofit kit.** 1/4" nosepiece and jaws for additional cost.

- PRG540-44 1/4" Jaw Set
- PRG540-46 3/16" Jaw Set
- PRG740-7A 1/4" Jaw Pusher
- PRG510-130 Jaw Lube

- Nosepieces:**
- PRN414 1/8" Open End
  - PRN514 5/32" Open End
  - PRN614 3/16" Open End
  - PRN811 1/4" Open End



Weight.....4.5 lbs.  
Stroke.....11/16"  
Pulling Force.....3000 lbs.  
Pressure.....85 psi  
Air Consumption:.....0.022 cf/rivet

Material		Rivet Diameter					T-Rivets		UltraGrip	
Rivet	Mandrel	3/32"	7/64"	1/8" & 5/32"	3/16"	1/4"	3/16"	1/4"	3/16"	1/4"
Alum.	Alum.	•		•/○	•/○	•/○	•	•	•	•
Alum.	Steel	•		•/○	•/○	•/○	•	•	•	•
Steel	Steel	•		•	•/○	•/○	•	•	•	•
Monel	Steel		•	•	•	•				
Stainless	Steel			•	•	•			•	•
Stainless	Stainless			•/○	•/○	•/○			•	•

• - Open end rivet ○ - Closed end rivet

## POP® Model MCS540 Air/Hydraulic Riveter

Ideal for high production assembly. World's most widely used blind riveter, designed to increase productivity. Sets the entire range of rivets. Sets high strength structural 1/4" rivets and 1/4" stainless Ultra-Grip rivets. 1/4" nosepiece and jaws for additional cost. **Equipped with Mandrel Collection System (MCS).**

- PRG540-44 1/4" Jaw Set
- PRG540-46 3/16" Jaw Set
- PRG740-7A 1/4" Jaw Pusher
- PRG510-130 Jaw Lube

- Nosepieces:**
- PRN414 1/8" Open End
  - PRN514 5/32" Open End
  - PRN614 3/16" Open End
  - PRN811 1/4" Open End



Weight.....4.5 lbs.  
Stroke.....11/16"  
Pulling Force.....3000 lbs.  
Pressure.....85 psi  
Air Consumption:.....2 cf/rivet

Material		Rivet Diameter					T-Rivets		UltraGrip	
Rivet	Mandrel	3/32"	7/64"	1/8" & 5/32"	3/16"	1/4"	3/16"	1/4"	3/16"	1/4"
Alum.	Alum.	•		•/○	•/○	•/○	•	•	•	•
Alum.	Steel	•		•/○	•/○	•/○	•	•	•	•
Steel	Steel	•		•	•/○	•/○	•	•	•	•
Monel	Steel		•	•	•	•				
Stainless	Steel			•	•	•			•	•
Stainless	Stainless			•/○	•/○	•/○			•	•

• - Open end rivet ○ - Closed end rivet





# POP® Blind Riveters

## POP® Model PROSET2500 & PROSET2500MCS Air/Hydraulic Riveter

Mid-range air-hydraulic riveter designed to set blind rivets up to and including 3/16" diameter. Ergonomically engineered with a light trigger for easy one-hand operation. **Model PROSET2500MCS** equipped with Mandrel Collection System (MCS).

<b>13300</b>	Jaw Set (3pc.)	<b>Nosepieces:</b>	
<b>FAN275-028</b>	1/8" & 5/32" Pusher	<b>PRN414</b>	1/8" Open End
<b>DPN275-027</b>	3/16" Pusher	<b>PRN514</b>	5/32" Open End
<b>PRG510-130</b>	Jaw Lube	<b>PRN614</b>	3/16" Open End



2500 Weight.....	2.65 lbs.
2500MCS Weight.....	2.89 lbs.
Stroke.....	0.71"
Pulling Force.....	2110 lbs.
Pressure.....	90 psi
Air Inlet.....	1/4"
Air Consumption:.....	0.076 cf/rivet
MCS Air Consumption:.....	2.47 cfm

Material		Rivet Diameter		T-Rivets	UltraGrip
Rivet	Mandrel	1/8" & 5/32"	3/16"	1/8" to 3/16"	3/16"
Alum.	Alum.	●/○	●/○		●
Alum.	Steel	●/○	●/○	●	
Steel	Steel	●/○	●/○		●
Monel	Steel	●	●/†		
Copper	Steel	○			
Stainless	Stainless	●/○	●/○/†		●

● - Open end rivet ○ - Closed end rivet † - Except Multi-Grip

## POP® Model PROSET3400 & PROSET3400MCS Air/Hydraulic Riveter

Capable of setting the entire range of rivets. Sets most 1/4" rivets with a single pull. Lightweight tool allows operator easy maneuverability. **Model PROSET3400MCS** equipped with Mandrel Collection System (MCS).

<b>PRG540-44</b>	1/4" Jaw Set	<b>Nosepieces:</b>	
<b>PRG540-46</b>	3/16" Jaw Set	<b>PRN414</b>	1/8" Open End
<b>FAN276-064</b>	1/8" & 5/32" Pusher	<b>PRN514</b>	5/32" Open End
<b>DPN276-006</b>	3/16" & 1/4" Pusher	<b>PRN614</b>	3/16" Open End
<b>PRG510-130</b>	Jaw Lube	<b>PRN811</b>	1/4" Open End



3400 Weight.....	4.19 lbs.
3400MCS Weight.....	4.41 lbs.
Stroke.....	1.02"
Pulling Force.....	3400 lbs.
Pressure.....	90 psi
Air Inlet.....	1/4"
Air Consumption:.....	0.172 cf/rivet
MCS Air Consumption:.....	2.83 scfm

Material		Rivet Diameter		T-Rivets	UltraGrip
Rivet	Mandrel	1/8" to 1/4"	1/8" to 1/4"	3/16" to 1/4"	
Alum.	Alum.	●/○			●
Alum.	Steel	●/○		●	
Steel	Steel	●/○			●
Stainless	Stainless	●/○			●

● - Open end rivet ○ - Closed end rivet

## POP® Model PRT5250A & MCS5250A Air/Hydraulic Riveter

Unique, lightweight, straight lever-operated riveter capable of setting commercial blind rivets up to and including 3/16" diameter. Ideal for assembly line production. **Model MCS5250A** equipped with Mandrel Collection System (MCS).

<b>PRG540-46</b>	3/16" Jaw Set
<b>PRG520-33</b>	Jaw Pusher
<b>PRG510-130</b>	Jaw Lube

<b>Nosepieces:</b>	
<b>PRN414</b>	1/8" Open End
<b>PRN514</b>	5/32" Open End
<b>PRN614</b>	3/16" Open End



PRT5250A Weight.....	3.9 lbs.
MCS5250A Weight.....	4.8 lbs.
Stroke.....	0.63"
Pulling Force.....	1700 lbs.
Pressure.....	85 psi
Air Inlet.....	1/4"
Air Consumption:.....	0.028 cf/rivet
MCS Air Consumption:.....	12.5 cfm

Material		Rivet Diameter			T-Rivets	UltraGrip
Rivet	Mandrel	3/32"	7/64"	1/8" to 3/16"	3/16"	3/16"
Alum.	Alum.	●		●/○		●
Alum.	Steel	●		●/○	●	
Steel	Steel	●		●/○		●
Monel	Steel		●	●		
Stainless	Steel			●		●
Stainless	Stainless			●/○		●

● - Open end rivet ○ - Closed end rivet

## POP® Model PRT5400 & MCS5400 Air/Hydraulic Riveter

Sets most 1/4" rivets with a single pull. Capable of setting the entire range of rivets. Lightweight tool allows operator easy maneuverability. **Model MCS5400** equipped with Mandrel Collection System (MCS).

<b>PRG540-44</b>	1/4" Jaw Set	<b>Nosepieces:</b>	
<b>PRG540-46</b>	3/16" Jaw Set	<b>PRN414</b>	1/8" Open End
<b>PRT5500-6</b>	3/16" Pusher	<b>PRN514</b>	5/32" Open End
<b>PRT5500-8</b>	1/4" Pusher	<b>PRN614</b>	3/16" Open End
<b>PRG510-130</b>	Jaw Lube	<b>PRN811</b>	1/4" Open End



PRT5400 Weight.....	4.63 lbs.
MCS5400 Weight.....	4.96 lbs.
Stroke.....	0.63"
Pulling Force.....	3400 lbs.
Pressure.....	85 psi
Air Inlet.....	1/4"
Air Consumption:.....	0.028 cf/rivet
MCS Air Consumption:.....	2 cfm

Material		Rivet Diameter				T-Rivets	UltraGrip
Rivet	Mandrel	3/32"	7/64"	1/8" to 3/16"	1/4"	3/16" to 1/4"	3/16" to 1/4"
Alum.	Alum.	●		●/○	●		●
Alum.	Steel	●		●/○	●/○	●	
Steel	Steel	●		●/○	●/○		●
Monel	Steel		●	●	●		
Stainless	Steel			●			●
Stainless	Stainless			●/○			●

● - Open end rivet ○ - Closed end rivet

# Blind Riveters, Rivet-Nut Tools & Hydraulic Pumps



**Michigan Pneumatic HCS Series** pumps are built to last. Constructed of high quality, industrial grade materials, these pumps can be depended upon for high production assembly work. Heavy steel box with removable front panel for quick inspection. Convenient features include externally adjustable air pressure, top mounted oil filler cap, flush mounted air and hydraulic pressure gauges, and sight glass to monitor oil level. The spring loaded handles allow for easy packing and transportation.

The **MPT HCS Series** high-volume hydraulic pumps are designed for accurate, repeatable fastener installations once oil pressure and air pressure have been regulated.

These versatile pumps can easily be converted to overhead, suspended pumps for trolley-mounted moving assembly line applications. Other special modifications can be made at additional costs.



## Michigan Pneumatic Model MP-HCS-1000HD Hydraulic Riveter Pump

Designed to replace the Chicago Pneumatic Model CP-0805ARDR power rigs. Considerably quieter and faster than any competitive product. Powers all CP pneumatic, riveting and broaching tools such as the CP-503, 505, 505A, 507, 507A and 509A. Comes equipped with an 8 ft. hose and an overhose protector. Longer length hoses available. **Riveter and yoke not included.**

Length.....	18-1/4"	Pressure.....	7000 psi
Width.....	12-1/4"	Volume.....	100 cu. in./min.
Height.....	22-1/4"	Rec'd Hose Size.....	3/8"
Weight.....	95 lbs.	Air Inlet Thread.....	1/2"



MP-7403-ST

## Michigan Pneumatic Model MP-7403-ST Model MP-7503-ST

### Pneumatic/Hydraulic Riveters

Rugged tools suitable for setting steel rivets. Lightweight design for pulling most size rivets. Air relief prevents overloading. The most practical and versatile rivet tools in the industry. **Model MP-7403-ST includes nosepieces for 3/32", 1/8", 5/32" and 3/16" rivets. Model MP-7503-ST includes nosepieces for 3/32", 1/8", 5/32", 3/16", 7/32" and 1/4" rivets.**

#### MP-7403-ST (only):

- 2020-05 Jaw Set
- 2020-06 Jaw Pusher
- 2020-04 Jaw Case

#### MP-7503-ST (only):

- 3057-62 Jaw Set
- 3057-08A Jaw Pusher
- 3057-061A Jaw Case

Model	MP-7403-ST	MP-7503-ST
Capacity	3/16" Steel	1/4" Steel
Height	10"	13"
Weight	3.25 lbs.	4.625 lbs.
Rec'd Hose Size	1/4"	3/8"
Air Inlet Thread	1/4"	1/4"
Avg. Air Consumption	3.5 cfm	4.5 cfm



PNT800L-PC-T

PNT1000L-PC-T

## POP® Model PNT800L-PC-T Model PNT1000L-PC-T

### POP NUT™ Tools

Lightweight tools designed for installing POP NUT™ blind rivet nuts and other blind threaded inserts utilizing the *setting force*. Controlling the setting force eliminates application and nut damage due to "double stroking." **Available with unified or metric threaded mandrel. Sold with one nose assembly of your choice. Please specify.**

Model	PNT800L-PC-T	PNT1000L-PC-T
Thread Size	8-32 to 3/8"-16	1/4"-20 to 1/2"-13
Height	10.4"	11.6"
Weight	3.99 lbs.	6.11 lbs.
Rec'd Hose Size	1/4"	1/4"
Air Inlet Thread	1/4"	1/4"

# Blind Riveters & Accessories



## POP® Model PS15

### Advanced Manual Riveter

Improved ergonomic hand tool features shorter nose housing, innovative latch design, patented compound link, soft contoured handles, shorter grip opening for easy one-hand operation and a new overall design to minimize friction and improve performance.



Material		Rivet Diameter		
Rivet	Mandrel	3/32"	1/8"	5/32" & 3/16"
Alum.	Alum.	•		•/○/★
Alum.	Steel	•		•/○/★
Steel	Steel			
Stainless	Stainless		•	

• - Open end rivet ○ - Closed end rivet ★ - Multi-Grip

## POP®

### Mandrel Collection System

This vacuum design holds the rivet securely in the nosepiece, even when the tool is pointed down. When the rivet is set, the spent mandrel is instantly propelled into the collection bottle at the rear of the tool. Reduces shop cleanup time, promotes safety, improves product quality, and minimizes downtime.



#### Retrofit Kit for PRT/PRG Tools

Tool Model No.	Kit No.
PRG510/PRG511	MCS510-100
PRG540	MCS540-100
PRT5200	MCS5200-100
PRT5400	MCS5400-100

Collector capacity: 500 1/8" rivets; 300 3/16" rivets; 400 5/32" rivets; 100 1/4" rivets

## POP® Model ProSet® 1600 & ProSet® 1600MCS

### Air/Hydraulic Riveter

Features an innovative left or right, On/Off swivel air fitting providing additional flexibility, conserving energy and reducing operating costs. The 1600 will set 2.0 mm Micro Rivets, 3/32" and 1/8" diameter rivets in all materials and up to 5/32" all steel open end rivets.



Material		Rivet Diameter	
Rivet	Mandrel	3/32" & 1/8"	5/32"
Aluminum	Aluminum	•/○	•/○
Aluminum	Steel	•/○	•/○
Steel	Steel	•/○	•/†
Copper	Steel	○	○
Stainless	Stainless	•/○	
Monel	Steel	•	

• - Open end rivet ○ - Closed end rivet † - Except Multi-Grip

## POP® Model PRH850

### Rivetool Corner Head

Designed for setting "POP" Rivets in restricted areas not accessible for straight riveting. Sets rivets at 90° angle. Excellent for corner assembly. **Adaptable to the PRG540 tool only, using PRH850-540 adaptor.**



Material		Rivet Diameter	
Rivet	Mandrel	3/16"	1/4"
Aluminum	Aluminum	•/○	
Aluminum	Steel	•/○	•/○
Steel	Steel	•	•
Monel	Steel	•	•
Stainless	Stainless	•	•

• - Open end rivet ○ - Closed end rivet

## POP® Model MSC5800

### Portable/Rechargeable Riveter

Ideal for site and maintenance work. Useful alongside a moving line or where access to a pneumatic line is impossible. Battery pack has the endurance to set up to 1900 rivets and can be recharged in an hour. **Equipped with Mandrel Collection System (MCS).**

**MCS5800-40** Battery  
**MCS5800-45** Battery Charger



Sets ..... 3/32" to 3/16",  
all materials  
Stroke.....0.787"  
Recharge.....1 hour  
Power.....Built-in,  
rechargeable 12V battery

## FAR Model RAC180

### Model RAC171

### Air/Hydraulic Riveter

Lightweight, ergonomic design features front center swivel air port, push button trigger and vacuum collection system.



**Model RAC180**  
Capacity.....1/4" Aluminum  
Stroke.....0.775"  
Weight.....4.2 lbs.  
Avg. Air Consumption: .....5 cfm

**Model RAC171**  
Capacity.....1/4" Monobolt®  
Stroke.....0.775"  
Weight.....5.5 lbs.  
Avg. Air Consumption .....11.4 cfm



The tool shown on this page has been specifically designed to install the A-L, A-K, A-H, A-P and A-O Series Inserts.

Select the type of insert (not shown) and thread size required for your application, then select the appropriate RPM tool from the charts below.

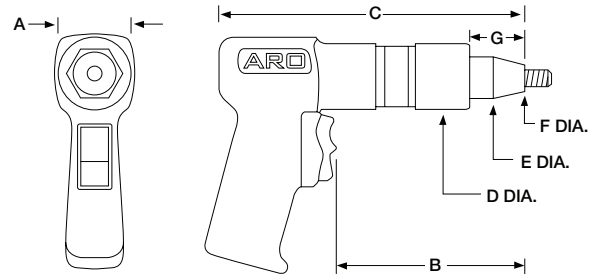

### Dimensional Data

RPM	Weight (Lbs.)	A	B	C	D (Dia.)	E (Dia.)	F (Dia. Max.)	G
3000	2.55	1.86"	4.75"	7.75"	1.57"	1.00"	0.400"	1.3"
1500	2.58	1.86"	4.75"	7.75"	1.57"	1.00"	0.400"	1.3"
900	3.18	1.86"	6.00"	9.00"	1.57"	1.00"	0.500"	1.3"
600	3.18	1.86"	6.00"	9.00"	1.57"	1.00"	0.640"	1.3"
350	3.25	1.86"	5.37"	8.37"	1.50"	1.42"	0.900"	NA

### PROPER AIR SUPPLY SET-UP REQUIRES:

- Refer to tool selection chart below for proper PSI setting at 25 CFM
- Inline oiler / separator
- Air pressure gauge
- 5/16 minimum hose ID
- 5/16 minimum fittings ID

### PREVENTATIVE MAINTENANCE REQUIREMENTS:

- The bearing set must be kept in a WET lubricated condition to assure proper tool operation. AVK suggests the use of high temperature grease such as LUBRIPLATE BRAND 930 AA.
- The tool mandrel should be inspected for thread wear or damage and replaced. AVK suggests the use of Unbrako or Holo-Krome socket head cap screws.

### EXPLODED VIEW

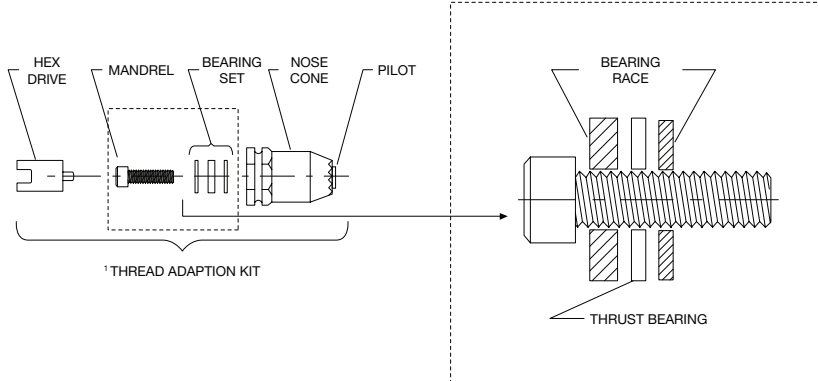

**SPECIAL FEATURE** — This tool nose cone design incorporates a special pilot / serrated tip that is essential to proper insert installation. The "AK" prefix in the tool part number designates this feature.

### Tool Selection

Model No. (Complete Tool)	Thread Size	RPM	<sup>1</sup> Thread Adaption Kit	PSI (Dynamic)
AKPT30P632	6-32 UNC	3000	AKPT632TAK	70-80
AKPT30P832	8-32 UNC	3000	AKPT832TAK	75-90
AKPT15P1024	10-24 UNC	1500	AKPT1024TAK	60-80
AKPT15P1032	10-32 UNF	1500	AKPT1032TAK	60-80
AKPT9P420	1/4"-20 UNC	900	AKPT420TAK	70-90
AKPT6P518	5/16"-18 UNC	600	AKPT518TAK	80-110
AKPT6P616	3/8"-16 UNC	600	AKPT616TAK	80-110
AKPT3P813	1/2"-13 UNC	350	AKPT813CTA	80-110
AKPT30P470	M4x0.7 ISO	3000	AKPT470TAK	70-80
AKPT15P580	M5x0.8 ISO	1500	AKPT580TAK	60-80
AKPT9P610	M6x1.0 ISO	900	AKPT610TAK	70-90
AKPT6P8125	M8x1.25 ISO	600	AKPT8125TAK	80-110
AKPT6P1015	M10x1.5 ISO	600	AKPT1015TAK	80-110
AKPT3P12175	M12x1.75 ISO	350	AKPT12175CTA	80-110

### Spare Parts

Hex Drive	<sup>2</sup> Mandrel (10 Per Bag)	Bearing Set	Nose Cone
29NPT22	B3SH632-1500	32PT1	77AKPT6
29NPT23	B3SH832-1500	32PT2	77AKPT8
29NPT4	B3SH1024-1750	32PT4	77AKPT10
29NPT4	B3SH1032-1750	32PT4	77AKPT10
29NPT5	B3SH420-1500	32PT5	77AKPT250
29NPT6	B3SH518-2000	32PT7	77AKPT3125
29NPT7	B3SH616-2000	32PT8	77AKPT375
29NPT26	B3SH813-2500	30NPT500	77AKPT500
29NPT24	B3SH470-40	32PT3	77AKPT470
29NPT10	B3SH580-45	32PT4	77AKPT580
29NPT11	B3SH610-40	32PT6	77AKPT610
29NPT12	B3SH8125-50	32PT7	77AKPT8125
29NPT25	B3SH1015-50	32PT10	77AKPT1015
29NPT27	B3SH12175-60	30NPT500	77AKPTM12

Note: UNF Fine Threads are Available

<sup>2</sup> Special order only



Michigan Pneumatic

## Punch/Flange Tools

Two-in-one quarter-paneling tool is ideal for crimping or flanging panels together. Also great for punching clean holes for any operation.



MP-AP650-ST



MP-AP600ST8



MP-AP600PT-A

Model No.	Punch Capacity	Flange Capacity	Length	Weight	Rec'd Hose Size	Air Inlet Thread	Avg. Air Consumption
MP-AP600PT-A	3/16" Hole	14 gauge	7-1/2"	2.25 lbs.	3/8"	1/4"	4 cfm
MP-AP650-ST	3/16" Hole	14 gauge	9-5/8"	2.70 lbs.			
MP-AP600ST8	5/16" Hole	14 gauge	10"	3.00 lbs.			

Michigan Pneumatic **MP-050K-DD**

## Punch/Flange Tool Kit

Two-in-one quarter-paneling tool is ideal for crimping or flanging panels together. Also great for punching clean holes for any operation. **Includes plastic case, one flange head, and 4 punch heads (Sizes 4, 5, 6.5, & 8mm).**



4mm 5mm 6.5mm 8mm Flange Head

Punch Capacity .....	5/16" Hole	Rec'd Hose Size .....	3/8"
Flange Capacity .....	15 gauge	Air Inlet Thread .....	1/4"
Length .....	11-7/32"	Avg. Air Consumption .....	4 cfm
Weight .....	2.86 lbs.		

Michigan Pneumatic **Model MP-9361**  
**Model MP-9100**

## Engraving Pen

Writes on a variety of materials such as steel up to RC-64, glass, plastic and wood. Can be used for deburring and trimming, and is excellent for removing broken studs. A must for paleontologists and aircraft parts manufacturers. **Includes hose, filter, #7177 stylus and plastic carrying case.**

MP-9100

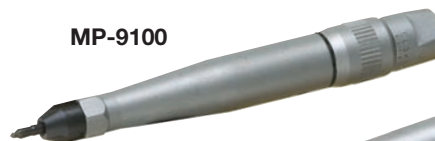

MP-9361

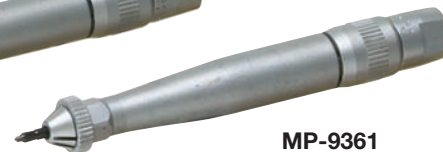

- #7177 Carbide Tip Stylus
- #84625 Solid Carbide Stylus Kit  
Includes: 1 Solid Carbide Stylus, 2 O-rings, 1 Special Guide
- #7425 Chisel Kit (MP-9361 only)  
Includes: 1 each Wide Chisel, Blank Chisel, Cape Chisel & Anvil

Length .....	5"
Weight .....	5 oz.
Rec'd Hose Size .....	1/4"
Air Inlet Thread .....	1/8"
Avg. Air Consumption .....	1 cfm



Michigan Pneumatic **Model MP-AS8-ST**

## Paint Spray Gun

High production spray gun designed to handle all lacquers, enamels, and any automotive refinishing materials.



Feed Type .....	Suction
Fluid Nozzle Size .....	5/8"
Cup Capacity .....	1 Quart
Height .....	11-1/2"
Length .....	5"
Weight .....	2.3 lbs.
Rec'd Hose Size .....	3/8"
Air Inlet Thread .....	1/4"
Avg. Air Consumption .....	8 cfm

# Rivet Squeezers



Michigan Pneumatic

## “Alligator” Yoke Riveters

Alligator type compression riveter has wide applications in many industries for squeezing a large variety of size and type of rivets. Strong squeeze action is easily controlled to provide uniformity and accuracy of work. Ideally used for dimpling, punching and pressing. Extra powerful, portable tandem cylinder also available with double the compressive force for larger riveting capacity. **Parts are interchangeable with Chicago Pneumatic 0214-A series riveters.**

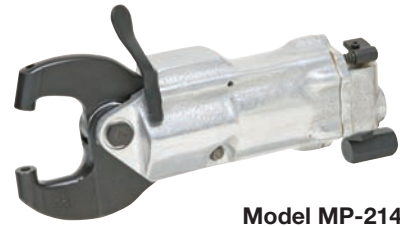

Model MP-2144A-112

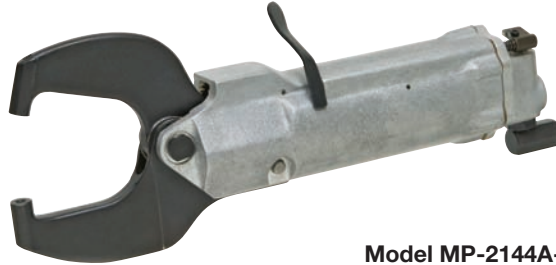

Model MP-2144A-TAN-3



### Compression Riveters, “Alligator” Yoke

Model No.	Rivet Capacity		Yoke Reach	Yoke Gap	Closed Height	Shank Diameter	Max. Force	Max. Travel	Length	Weight w/Yoke
	Alum.	Steel								
MP-2144A-112	1/8"		1-1/2"	1-5/8"			3000 lbs.	5/8"	9-3/16"	3.75 lbs.
MP-2144A-214	1/8"	3/32"	2-1/4"	2-1/8"	7/8"	0.187"	2200 lbs.	7/8"	10-1/8"	4.25 lbs.
MP-2144A-3	3/32"		3"	2-1/8"			1800 lbs.	1-1/4"	10-7/8"	4.75 lbs.

### Tandem Compression Riveters, “Alligator” Yoke

Model No.	Rivet Capacity		Yoke Reach	Yoke Gap	Closed Height	Shank Diameter	Max. Force	Max. Travel	Length	Weight w/Yoke
	Alum.	Steel								
MP-2144A-TAN-112	3/16"	5/32"	1-1/2"	1-5/8"	7/8"	0.187"	6000 lbs.	5/8"	12"	5.50 lbs.
MP-2144A-TAN-214	5/32"	1/8"	2-1/4"	2-1/8"	7/8"	0.187"	4300 lbs.	7/8"	13"	6.00 lbs.
MP-2144A-TAN-3	1/8"	3/32"	3"	2-1/8"			3400 lbs.	1-1/4"	13-3/4"	6.25 lbs.

Michigan Pneumatic

## “C” Yoke Riveters

Specially designed for airplane construction to ensure fast, economical riveting where two-man operation is impractical. Features strong, steady, silent squeeze action, which is easily controlled for a large variety of rivets. Ideal for dimpling, punching, stamping and pressing. Widely used for truck, bus and automotive applications. Extra powerful, portable tandem cylinder also available with double the compressive force for larger riveting capacity. **Parts are interchangeable with Chicago Pneumatic 0214-C series riveters.**

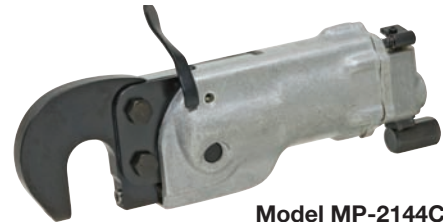

Model MP-2144C-112

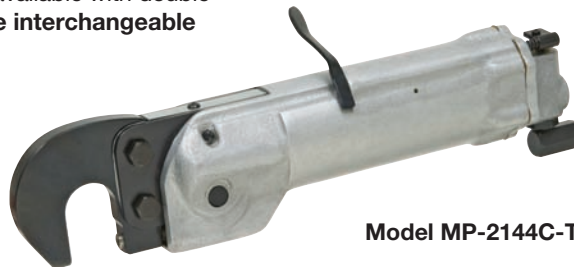

Model MP-2144C-TAN-112



### Compression Riveters, “C” Yoke

Model No.	Rivet Capacity		Yoke Reach	Yoke Gap	Closed Height	Shank Diameter	Max. Force	Max. Travel	Length	Weight w/Yoke
	Alum.	Steel								
MP-2144C-112			1-1/2"							
MP-2144C-2	1/8"	3/32"	2"	1-1/4"	11/16"	0.187"	3000 lbs.	9/16"	10-5/16"	4.5 lbs.
MP-2144C-212			2-1/2"							
MP-2144C-3			3"							

### Tandem Compression Riveters, “C” Yoke

Model No.	Rivet Capacity		Yoke Reach	Yoke Gap	Closed Height	Shank Diameter	Max. Force	Max. Travel	Length	Weight w/Yoke
	Alum.	Steel								
MP-2144C-TAN-112			1-1/2"							
MP-2144C-TAN-2	3/16"	5/32"	2"	1-1/4"	11/16"	0.187"	6000 lbs.	9/16"	14"	5.5 lbs.
MP-2144C-TAN-212			2-1/2"							
MP-2144C-TAN-3			3"							

# Rivet Squeezers



Michigan Pneumatic

## “Alligator” Yoke Riveters

Designed for one-man operation to increase productivity where costly two-man riveting was once done. Used in high volume riveting applications. Capable of accurately squeezing a large variety of solid, tubular and semi-tubular rivets in aircraft, truck, bus, boat, toy and automotive component applications. A tandem cylinder doubles the compressive force of the standard tool, allowing the operator to upset larger size rivets, as well as rivets made of stronger material. **All models: Plain backhead; 1/4" (NPTF) air inlet thread. MP-351: Short stroke adjustment; CR-1 rivet shank holes. Model 351FCT08 foot pedal control available.**



MP-351A-278



### Compression Riveters, “Alligator” Yoke

Model No.	Rivet Capacity		Yoke Reach	Yoke Gap	Closed Height	Shank Diameter	Max. Force	Max. Travel	Length	Weight w/Yoke
	Alum.	Steel								
MP-351A-918	1/8"	3/32"	9-1/8"	2-3/16"	3/4"	0.187"	3000 lbs.	1-11/16"	25-3/4"	26.25 lbs.
MP-351A-7	1/8"	3/32"	7"	2"	1-1/2"		3000 lbs.	1-11/16"	23-5/8"	24.25 lbs.
MP-351A-5	1/8"	3/32"	5"	1-5/8"	7/8"		3400 lbs.	1-3/8"	21-5/8"	19.75 lbs.
MP-351A-278	5/32"	1/8"	2-7/8"	1-5/8"	7/8"		5200 lbs.	5/8"	19-1/2"	15.75 lbs.

### Tandem Compression Riveters, “Alligator” Yoke

Model No.	Rivet Capacity		Yoke Reach	Yoke Gap	Closed Height	Shank Diameter	Max. Force	Max. Travel	Length	Weight w/Yoke
	Alum.	Steel								
MP-351A-TAN-918	3/16"	5/32"	9-1/8"	2-3/16"	3/4"	0.187"	6000 lbs.	1-11/16"	30"	29.00 lbs.
MP-351A-TAN-7	3/16"	5/32"	7"	2"	1-1/2"		6000 lbs.	1-11/16"	27-7/8"	27.00 lbs.
MP-351A-TAN-5	3/16"	5/32"	5"	1-5/8"	7/8"		6800 lbs.	1-3/8"	25-7/8"	22.50 lbs.
MP-351A-TAN-278	1/4"	3/16"	2-7/8"	1-5/8"	7/8"		10400 lbs.	5/8"	23-3/4"	18.50 lbs.

Michigan Pneumatic

## “C” Yoke Riveters

Lightweight, compact, used extensively in electronic chassis, metal furniture, aircraft, automotive component, boat, truck and bus building applications. Can also be used for staking, stamping, pressing or crimping service. Air inlet swivel aids maneuverability. Squeezes uniformly every time trigger is actuated, independent of operator skill. Using a compressing tool ensures all joints are of the highest integrity. **All models: Plain backhead; 1/4" (NPTF) air inlet thread. CR-1 rivet shank holes; MP-351: Short stroke adjustment. Model 351FCT08 foot pedal control available.**



MP-351C-218



### Compression Riveters, “C” Yoke

Model No.	Rivet Capacity		Yoke Reach	Yoke Gap	Closed Height	Shank Diameter	Max. Force	Max. Travel	Length	Weight w/Yoke
	Alum.	Steel								
MP-351C-218	3/16"	5/32"	2-1/8"	1-3/16"	25/32"	0.187"	6000 lbs.	9/16"	17-1/2"	12.50 lbs.

### Tandem Compression Riveters, “C” Yoke

Model No.	Rivet Capacity		Yoke Reach	Yoke Gap	Closed Height	Shank Diameter	Max. Force	Max. Travel	Length	Weight w/Yoke
	Alum.	Steel								
MP-351C-TAN-218	1/4"	7/32"	2-1/8"	1-3/16"	25/32"	0.187"	12000 lbs.	9/16"	21-3/4"	15.25 lbs.

Other yokes also available. See pages 94-97 for accessories.

# Rivet Squeezer Accessories



## MP-351C & CP-0351 Series "C" Yokes

Fits standard Type 1 frame.

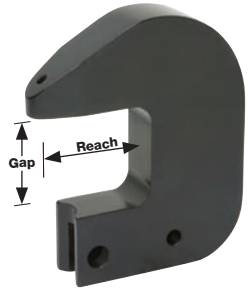

No.	Reach	Gap
016	1-3/16"	2-5/8"
017	3-1/2"	1-1/4"
018	2"	2"
019	5"	2-1/2"
020	2-1/8"	1-3/16"

## CP-0355 Series "C" Yokes

Includes bronze set holder bushings.

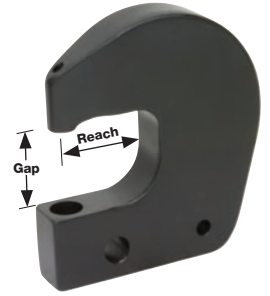

No.	Reach	Gap
P089777	2-1/8"	1-7/8"
P093213	4-1/2"	1-15/16"

## MP-2144C & CP-0214 Series "C" Yokes

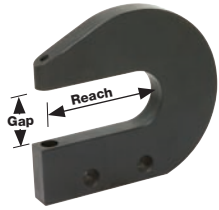

No.	Reach	Gap
001	1-1/2"	1-1/4"
002	2"	1-1/4"
003	2-1/2"	1-3/8"
004	3"	1-3/8"
005	2-3/4"	1-3/16"
006	1-3/4"	1-1/4"
007	1-3/16"	1-3/16"
012XP	3"	1-1/2"

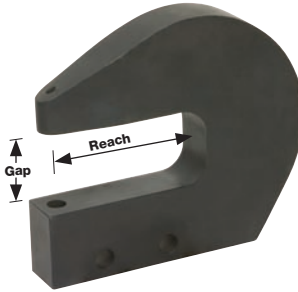

### Heavy-Duty Model

No.	Reach	Gap
008	3-7/8"	1-3/16"
009	5-5/8"	1-3/16"
010	5-3/8"	1-1/4"

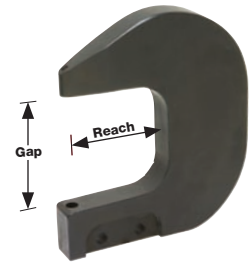

### Heavy-Duty Model

No.	Reach	Gap
011	2-1/2"	2"
012	3"	1-1/2"
013	3"	3"
014	3"	3-1/2"
015	3-1/2"	2"

## Michigan Pneumatic Model 351CON

### Riveter Conversion Unit

Conversion unit fits all "Alligator" or "C" type models MP-351 and CP-0351 compression riveters. Increases rivet capacity from 3/16" Dural to 5/16", and 5/32" steel to 1/4".



## Michigan Pneumatic Model 351RY

### Roof Top Rail Yoke

Fits MP-351 and CP-0351 "C" series riveters with Type 1 frames. Ideal for installing 3/16" and 1/4" rivets on most tractor trailer roof rails. **Requires at least SM210 flush set for the top of yoke and choice of additional cupped rivet set to be inserted in the moving set holder.**

<b>P003092RY</b>	5/16"-24 Bolt
<b>P073047RY</b>	7/16"-20 Bolt
<b>P003093</b>	5/16"-24 Nylock Nut
<b>P006315</b>	7/16"-20 Nylock Nut

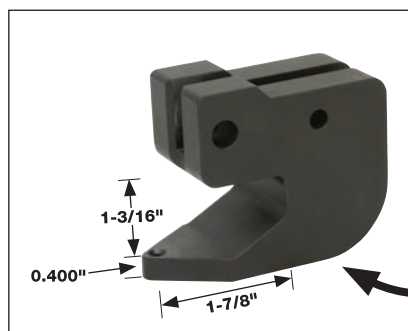



## Air-Operated Pedal Control

Converts standard lever-operated compression riveters to foot-operated for riveting applications where both hands are required to stabilize the product being riveted.

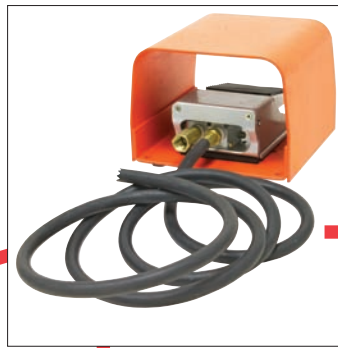

**Model**  
**2144FCT**

**Model**  
**351FCT08**

**Model**  
**450FCT**

**Model**  
**450EAFCT**

Can be installed on the following model riveters: **MP-2144**, **CP-0214**, **USI-114** and other riveters of the same design.

Includes a 6' hose assembly from the foot pedal to the back cap.

Can be installed on the following model riveters: **MP-351**, **CP-0351**, **USI-151** and **APT-740**.

Includes an 8' hose assembly from the foot pedal to the air valve and air intake.

Can be installed on the following model riveters: **CP-0450** and **USI-150**.

Comes with a 10' hose assembly from the foot pedal to the air valve and a 5' hose assembly from the air valve to the back cap. Includes all necessary hardware to mount the air valve and back cap.

Can be installed on the following model riveters: **CP-0450EA**, **USI-150EA** and **Zephyr ZP450EA**.

Comes with a 10' hose assembly from the foot pedal to the air valve and a 5' hose assembly from the air valve to the back cap. Includes all necessary hardware to mount the air valve and back cap.

### Michigan Pneumatic Model P078666G

## Cable-Operated Pedal Control

Allows standard lever-operated CP-0450 compression riveters to foot-operated applications requiring two hands.

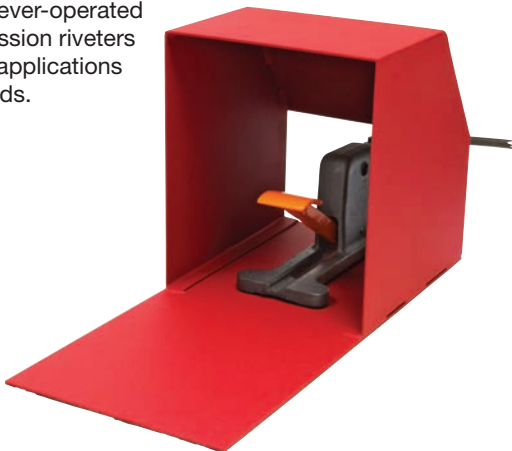

### Michigan Pneumatic Model P078214G

## Cable-Operated Pedal Control

Allows standard lever-operated CP-0351 & CP-0355 compression riveters to foot-operated applications requiring two hands. **Includes lever conversion kit.**

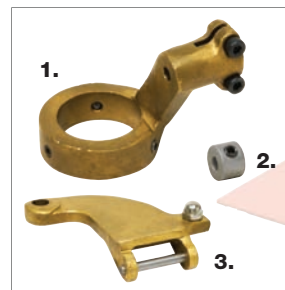

1. **P074830** Cable Casing Bracket
2. **P074827** Cable Collar
3. **P074831** Throttle Lever

# Rivet Squeezer Accessories



## Michigan Pneumatic Model 2144APS

### Air-Operated, Foot-Controlled Pedestal Stand

The 2144APS Pedestal Stand is used with the MP-2144, CP-214, or U.S. 114 Compression Riveters. This Bench Top Stand comes with the 2144FCT Air Foot Pedal Control Assembly that has a 6 ft. hose and has a working height of 12". This provides a hands-free option where components require both hands for stability.



Riveter not included.

## Michigan Pneumatic Model 351APS

### Air-Operated, Foot-Controlled Pedestal Stand

The 351APS pedestal stand is used with the CP-0351, U.S. 151, or APT 740 Compression Riveters. This stand comes with the 351FCT08 Air Foot Pedal Control Assembly that has 8 ft. hoses and has a working height of 41". This provides a hands-free option where components require both hands for stability.



Riveter not included.

## Michigan Pneumatic

### CP-0450 Pressure Pad Dolly



Model No.	Description
P078691	3/8" Pressure Pad Dolly
P078692	1/2" Pressure Pad Dolly

## Michigan Pneumatic

### CP-0450EA Shank Adapters

Allows standard CP-0450EA riveter to accept MP-351 & CP-0351 rivet squeezer rivet sets.

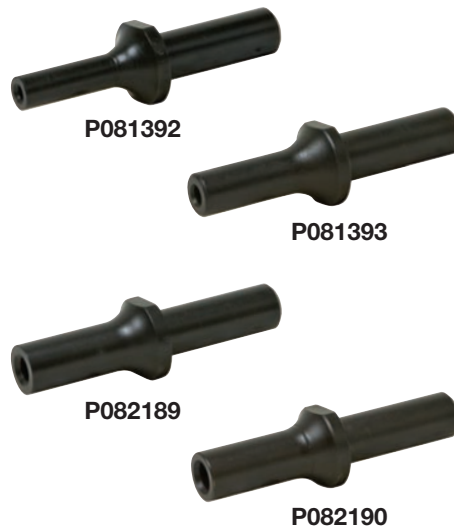

Model No.	Description
P081392	0.1875" Shank adapter
P081393	0.250" Shank Adapter
P082189	0.3125" Shank Adapter
P082190	0.375" Shank Adapter

## Michigan Pneumatic

### CP-0450EA Flush Sets



Model No.	Description
P081391	23/64" Flush Set
P085110	23/64" Flush Set, 3-1/2" Long
P081390	31/64" Flush Set
P081389	39/64" Flush Set



# Rivet Squeezer Accessories

## .187" Rivet Sets

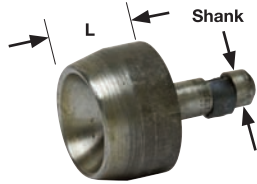

### Squeeze Riveter Sets

No.	L
SM200	1/4"
SM201	3/8"
SM202	1/2"
SM203	5/8"
SM204	3/4"

For example, to order:  
3/8" Long; 1/4" Button  
Specify: SM201-4358

Description	Rivet Diameter				
	3/32"	1/8"	5/32"	3/16"	1/4"
Round AN430	4303	4304	4305	4306	4308
Flat AN442	4423	4424	4425	4426	4428
Brazier AN455	4553	4554	4555	4556	4558
Mod. Brazier AN456	4563	4564	4565	4566	4568
Universal AN470	4703	4704	4705	4706	4708
Button AN435	4353	4354	4355	4356	4358

### Flush Sets

No.	L
SM210	1/8"
SM211	1/4"
SM212	3/8"
SM213	1/2"
SM214	5/8"
SM215	3/4"
SM217	1"

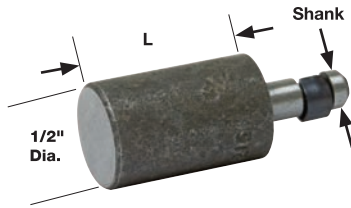

### Tubular Rivet Set

No.	L
SM200	1/4"
SM201	3/8"
SM202	1/2"
SM203	5/8"
SM204	3/4"

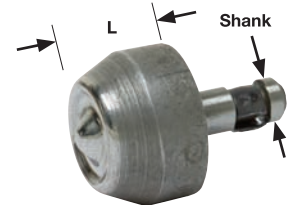

### Spacer Shims

No.	A
SM-S0	1/64" (0.0156")
SM-S1	1/32" (0.0312")
SM-S2	1/16" (0.0625")

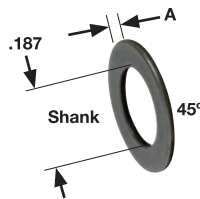

### Tubular AN-450

Rivet Diameter				
3/32"	1/8"	5/32"	3/16"	1/4"
4503	4504	4505	4506	4508

## .250"/.312"/.375" Rivet Sets

### Squeeze Riveter Sets

Rivet sets can be furnished in 1/4", 3/8", 1/2", 5/8" and 3/4" lengths and shank sizes. Please specify shank size, length and rivet.

For example, to order:  
1/4" Long; 1/8" Universal  
Specify: SM220-4704

Description	Rivet Diameter						
	3/32"	1/8"	5/32"	3/16"	1/4"	5/16"	3/8"
Round AN430	4303	4304	4305	4306	4308	43010	43012
Flat AN442	4423	4424	4425	4426	4428	44210	44212
Brazier AN455	4553	4554	4555	4556	4558	45510	45512
Mod. Brazier AN456	4563	4564	4565	4566	4568	45610	45612
Universal AN470	4703	4704	4705	4706	4708	47010	47012
Button AN435	4353	4354	4355	4356	4358	43510	43512

### .250 Shank

No.	L
SM220	1/4"
SM221	3/8"
SM222	1/2"
SM223	5/8"
SM224	3/4"

### .312 Shank

No.	L
SM240	1/4"
SM241	3/8"
SM242	1/2"
SM243	5/8"
SM244	3/4"

### .375 Shank

No.	L
SM260	1/4"
SM261	3/8"
SM262	1/2"
SM263	5/8"
SM264	3/4"

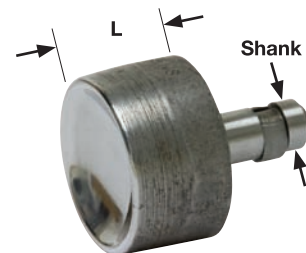

### Flush Sets

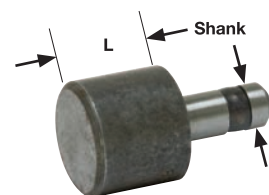

### .250 Shank

No.	L
SM230	1/8"
SM231	1/4"
SM232	3/8"
SM233	1/2"
SM234	5/8"
SM235	3/4"
SM236	7/8"
SM237	1"

### .312 Shank

No.	L
SM250	1/8"
SM251	1/4"
SM252	3/8"
SM253	1/2"
SM254	5/8"
SM255	3/4"
SM256	7/8"
SM257	1"

### .375 Shank

No.	L
SM270	1/8"
SM271	1/4"
SM272	3/8"
SM273	1/2"
SM274	5/8"
SM275	3/4"
SM276	7/8"
SM277	1"

**Some rivet/flush sets may require a six-piece minimum order. Please call for availability.**

# One Shot & Specialty Hammers



## Michigan Pneumatic Model MP-AH15

### Palm Hammer

Lightweight, palm-size air hammer replaces a variety of cumbersome hammers. Equipped with T-15-M plastic tip standard. Other interchangeable tips available in plastic, steel and aluminum.

Height.....	3-5/8"	Weight.....	2 lbs.	Air Inlet.....	1/4" NPT
-------------	--------	-------------	--------	----------------	----------



T-15-ST Steel    T-15-AL Aluminum    T-15-H Hard Plastic    T-15-M Med. Plastic    T-15-S Soft Plastic    T-15-SS Super-Soft Plastic



MP-RH20

MP-RH80

## Michigan Pneumatic Model MP-RH20 & MP-RH80

### One Shot Hammers

One shot hammer for delicate operations requiring lower power, including the insertion of pins, bushings, collar caps, oil seals, etc. Each lever pull delivers a single blow of precise power. The force of the hit can be regulated by adjusting the air pressure.

**RH8023** Snap Rivet Retainer    **RH8029** Snap Rivet

Model No.	Power	Length	Weight	Air Inlet Thread	Avg. Air Consumption
MP-RH20	0.23 kgf-m	8-3/8"	2.00 lbs.	1/4" MPT	0.008 cf/stroke
MP-RH80	0.32 kgf-m	10"	2.86 lbs.	1/4" MPT	0.023 cf/stroke



MP-RH90

MP-RH100Z

## Michigan Pneumatic Model MP-RH90 & MP-RH100Z

### One Shot Hammers

Heavy-duty, hammer for the insertion of pins, bushings, collar caps, oil seals, etc., requiring greater power. Each lever pull delivers a single powerful blow. Air pressure can be adjusted to regulate the force of each blow.

**RH100Z-28** Snap Rivet Retainer    **RH8029** Snap Rivet  
**RH100Z-29** Snap Rivet Ring

Model No.	Power	Length	Weight	Air Inlet Thread	Avg. Air Consumption
MP-RH90	0.60 kgf-m	12-29/32"	3.53 lbs.	1/4" MPT	0.042 cf/stroke
MP-RH100Z	0.90 kgf-m	12-23/32"	3.86 lbs.	1/4" MPT	0.053 cf/stroke



MADE U.S.A. IN THE

## Michigan Pneumatic Model MP-PRT20B

### One Shot Hammer

Straight hammer designed to insert roll and spring pins with one blow. Features ball type retainer for easy chisel removal and padded hand grip for operator comfort. Equipped with blank chisel.

**PHT-0019** Blank Chisel  
**PHT-0099** 3/4" Round Face Blank Chisel

Piston Stroke .....	3-1/4"	Length.....	11-3/8"
Bore.....	1"	Weight.....	3.85 lbs.
Shank Diameter .....	3/8"	Air Inlet Thread .....	1/4"



MADE U.S.A. IN THE

## Michigan Pneumatic Model MP-PHT10B

### One Shot Hammer

Pistol one-shot hammer with quick change retainer. Features a bail type hanger and ball type retainer. Special chisels can be manufactured with different length ball grooves to increase the travel distance or throw of the chisel. Equipped with blank chisel.

**PHT-0019** Blank Chisel  
**PHT-0099** 3/4" Round Face Blank Chisel

Piston Stroke .....	3-1/4"	Length.....	9-3/4"
Bore.....	1"	Weight.....	3.30 lbs.
Shank Diameter .....	3/8"	Air Inlet Thread .....	1/4"

# Pin Riveter & Automotive Air Hammer

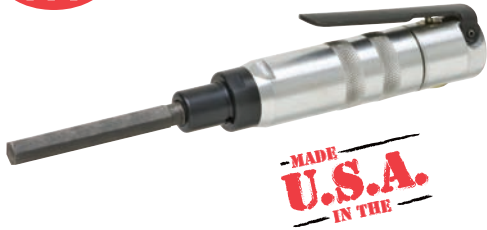

MADE  
U.S.A.  
IN THE

## Michigan Pneumatic Model MP-G43H

### Pin Riveter

Used for fine riveting applications such as very small rivets, brads, tacks and screws, and light peening and scaling applications. Can also be used for seating press-fit drive studs, drive screws and spring pins. Ideal for straightening shafts and broaches. **Available with 3/8" hex shank sets only.**

**PR043H004** Hex Driver

Blows Per Minute .....	9000	Length .....	6"
Rivet Capacity .....	1/16"	Weight .....	13 oz.
Stroke .....	1/2"	Air Inlet Thread .....	1/4"



## Michigan Pneumatic Model MP-T26

### Stone Tool

Carving hammer suitable for marble dressing, facade scaling and ornamental stone. Low air consumption, easy handling and high output makes this tool very practical.

<b>971CC</b>	1" Wide Chisel	<b>889MC</b>	1/2" Machine Chisel
<b>972CC</b>	1-1/4" Wide Chisel	<b>939MP</b>	3/4" 9-pt. Tool

Bore .....	1"	Length .....	7-11/16"
Stroke .....	1-3/16"	Weight .....	3 lbs.
Blows Per Minute .....	3500	Air Inlet Thread .....	1/4"

Chisel not included



## Michigan Pneumatic Model MP-5145-ST

### Air Hammer - Heavy Hitting

Features an independent power regulator, "teasing" throttle for operator control, and a one-piece metal motor housing for long life. Ideal for panel cutting and muffler removal. **0.401 shank.**

Piston Stroke .....	2-5/8"	Weight .....	3.5 lbs.
Blows Per Minute .....	3500	Air Inlet Thread .....	1/4"
Length .....	6-3/4"	Avg. Air Consumption .....	4 cfm



## Michigan Pneumatic Model MP-1020-F

### Air Hammer - Heavy Hitting

Designed for heavy-duty mechanical work. Cuts rivets off ball joints, shackle pins, universal joints, king pins, etc. Used for ripping, punching and driving. Features a durable, lightweight nylon handle. **0.401 shank. Made in U.S.A.**

Piston Stroke .....	2-3/4"	Weight .....	2.625 lbs.
Blows Per Minute .....	3700	Air Inlet Thread .....	1/4"
Length .....	6-1/4"	Avg. Air Consumption .....	4 cfm



## Michigan Pneumatic Model MP-1010-F

### Air Hammer - Extra Heavy-Duty

Designed for heavy-duty mechanical work. Cuts rivets off ball joints, shackle pins, universal joints, king pins, etc. A heavy-duty tool for heavy jobs. Features a durable, lightweight nylon handle. **0.401 shank. Made in U.S.A.**

Piston Stroke .....	3"	Weight .....	3.25 lbs.
Blows Per Minute .....	2600	Air Inlet Thread .....	1/4"
Length .....	7-1/2"	Avg. Air Consumption .....	4 cfm

# Aircraft Riveters



MP-30XG



NBH-400



MP-20XBU

These rivet hammers are among the most popular for aircraft riveting. Easily controlled, slow, heavy blows deliver just the right impact to form the rivet head without excessively work hardening the rivet or stretching the surrounding metal. Also handy for light chipping, scraping, metal cutting, peening and other hammering applications. All riveters are equipped with quick change and beehive retainer springs and feature removable front bushings.

**Most parts are interchangeable with Chicago Pneumatic 2X, 3X, 4X and CP-4444 series riveters.**



MP-40X

Model No.	Style	Dural Capacity	Steel Capacity	Bore & Stroke	Blows Per Minute	Shank Diameter	Length w/Retainer	Weight	Air Inlet Thread	Avg. Air Consumption
MP-9501X-SK	Offset Grip	5/32"	1/8"	9/16" x 1-3/8"	2850	0.401	5"	2.20 lbs.	1/4"	4 cfm
MP-2X-ST	Offset Grip	1/8"	3/32"	1/2" x 2-1/4"	2580	0.401	6-11/16"	2.25 lbs.	1/4"	4 cfm
MP-20X	Offset Grip						6-11/16"	2.25 lbs.		
MP-20XBU	Pushbutton						8"	2.00 lbs.		
MP-20XG	Pistol Grip						9-3/16"	3.88 lbs.		
MP-3X-ST	Offset Grip	3/16"	5/32"	1/2" x 2-7/8"	2160	0.401	7-5/16"	2.30 lbs.	1/4"	4 cfm
MP-30X	Offset Grip						7-5/16"	2.30 lbs.		
MP-30XBU	Pushbutton						8-5/8"	2.50 lbs.		
MP-30XG	Pistol Grip						10-13/16"	4.00 lbs.		
MP-4X-ST	Offset Grip	1/4"	3/16"	1/2" x 3-1/16"	1740	0.401	8-5/16"	2.75 lbs.	1/4"	4 cfm
MP-40X	Offset Grip						8-5/16"	2.75 lbs.		
MP-40XBU	Pushbutton						9-5/8"	2.50 lbs.		
MP-40XG	Pistol Grip						10-13/16"	4.50 lbs.		
NBH-400	Offset Grip	1/4"	3/16"	1/2" x 3-3/4"	1600	0.401	8-3/4"	3.10 lbs.	1/4"	4 cfm

## Optional Handles



Offset Grip



Pushbutton



Pistol Grip  
(Gooseneck)



MP-50X



NBH-600A



MP-90XG



MP-70X

These rivet hammers are among the most popular for aircraft riveting. Easily controlled, slow, heavy blows deliver just the right impact to form the rivet head without excessively work hardening the rivet or stretching the surrounding metal. Also handy for light chipping, scraping, metal cutting, peening and other hammering

applications. All riveters are equipped with quick change and beehive retainer springs and feature removable front bushings. **Most parts are interchangeable with Chicago Pneumatic 5X, 7X, 9X and CP-4447 series riveters. A 0.401 shank bushing, part no. HG-50215.401, also available for all 0.498 shank tools below.**

Model No.	Style	Dural Capacity	Steel Capacity	Bore & Stroke	Blows Per Minute	Shank Diameter	Length w/ Retainer	Weight	Air Inlet Thread	Avg. Air Consumption
MP-5X-ST	Offset Grip						8-15/16"	4.75 lbs.		
MP-50X	Offset Grip	1/4"	1/4"	3/4" x 2-11/16"	1560	0.498	8-15/16"	4.75 lbs.	1/4"	6 cfm
MP-50XG	Pistol Grip						12-3/4"	7.00 lbs.		
MP-70X	Offset Grip	3/8"	5/16"	3/4" x 5-13/16"	900	0.498	11-15/16"	6.00 lbs.	1/4"	6 cfm
MP-70XG	Pistol Grip						14-1/2"	8.25 lbs.		
NBH-600A	Offset Grip	5/16"	1/4"	3/4" x 2-11/16"	1500	0.498	9-5/8"	4.40 lbs.	1/4"	6 cfm
MP-90X	Offset Grip	5/16"	1/4"	3/4" x 3-7/8"	1140	0.498	10"	5.45 lbs.	1/4"	6 cfm
MP-90XG	Pistol Grip						13-3/8"	6.95 lbs.		

## Needle Scaler Attachment

For standard 0.498" shank riveters.  
3mmx12 Replacement Needles



NA-60

## Nail Driving Attachments

Ideal for dry dock construction, retaining wall construction, decks, fences and beam construction. Designed to increase production while reducing operator fatigue.



P042448



SD60-149A



P047810

Model No.	Shank Diameter	Max. Nail Head Diameter	Retainer Type	Length	Weight
P042448		9/16"	Double Spring	2-3/8"	1.13 lbs.
SD60-149A	0.498	3/4"	Solid Steel w/Nylon Insert	2-3/8"	1.00 lb.
P047810		7/8"	Double Spring	2-3/4"	1.25 lbs.

# Riveter & Air Hammer Accessories



Michigan Pneumatic

## Heavy-Duty Industrial Quality Chisels

For .401 & .498 Shank Riveting Hammers

For all air hammers, light riveting hammers, panel cutters and zip guns with .401 and .498 Parker taper shanks. Made of high grade alloy steel and heat treated for extremely durable service.

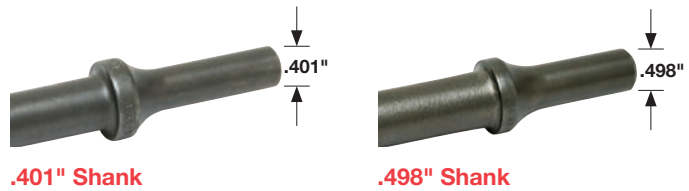

Description	Specify Shank Size	.401	.498
7" Chisel Blank		913	963
7" Flat Chisel		910	960
11" Flat Chisel		910-11FC	960-12
Moil Point		940	2P21
1-1/2" Wide Chisel		910-1.50	960-1.50
Muffler Cutter		908	-
Arvin Muffler Cutter		501	-
Single Bladed Panel Cutter		923PC	-
Double Bladed Panel Cutter		909	959
Spot Weld Breaker		914	-
Tail Pipe Cutter		902TP	-

Description	Specify Shank Size	.401	.498
Scraper		905	955
Body Ripper		907	-
Tapered Punch		911	961
Spoon Chisel		922	-
Tie Rod Tool		901TR	965TR
Bushing Remover		904	-
Bushing Cutter & Splitter		906	964
Shock Absorber		436	-
Body Forming Tool		2N181	-
Rivet & Bolt Cutter		912	962
Fork Chisel		903-1	968FC

\*Please specify size required.

## Non-Sparking .401" Shank Chisels

Beryllium copper safety chisels used for scraping and cutting applications where flammable vapors or residues are present.

**Model 910-2-BC**  
Wide Chisel



**Model 909-BC**  
Panel Cutter



Michigan Pneumatic

## Retainer Springs



Beehive



Quick Change

Style	Fits Most .401 Shank	Fits Most .498 Shank	Fits CP9311, CP9314, CP711 CP714, CP715	Fits AVC26, AVC10-13	Fits Cleco G4, G6, G8
Beehive	895	898	-	-	899
Quick Change	897	896	A046094	897-TW	-



# Riveter & Air Hammer Accessories



## .401" Shank Rivet Sets

For example, to order: 3-1/2" Long; 3/16" Flat  
Specify: SM10-4426

### Straight Type

Part No.	"L"
SM10	3-1/2"
SM11	5-1/2"
SM12	7-1/2"
SM13	10-1/2"
SM14	13-1/2"
SM50	3-1/2"



Description	Rivet Diameter						SM50		
	1/16"	3/32"	1/8"	5/32"	3/16"	1/4"	1/4"	5/16"	3/8"
Round AN430	4302	4303	4304	4305	4306	4308	-	43010	43012
Flat AN442	4422	4423	4424	4425	4426	4428	-	44210	44212
Brazier AN455	4552	4553	4554	4555	4556	4558	4558	45510	45512
Mod. Brazier AN456	4562	4563	4564	4565	4566	4568	-	45610	45612
Universal AN470	4702	4703	4704	4705	4706	4708	-	47010	47012
Button AN435	4352	4353	4354	4355	4356	4358	-	43510	43512

## .498" Shank Rivet Sets

For example, to order: 3-1/2" Long; 5/32" Universal  
Specify: SM30-4705

Part No.	"L"
SM30	3-1/2"
SM31	5-1/2"
SM32	7-1/2"
SM70	3-1/2"



Description	Rivet Diameter						SM70		
	3/32"	1/8"	5/32"	3/16"	1/4"	1/4"	5/16"	3/8"	
Round AN430	4303	4304	4305	4306	4308	-	43010	43012	
Flat AN442	4423	4424	4425	4426	4428	-	44210	44212	
Brazier AN455	4553	4554	4555	4556	4558	4558	45510	45512	
Mod. Brazier AN456	4563	4564	4565	4566	4568	-	45610	45612	
Universal AN470	4703	4704	4705	4706	4708	-	47010	47012	
Button AN435	4353	4354	4355	4356	4358	-	43510	43512	

## Flush Sets



0.401" Shank	0.498" Shank	Diameter	Length
SM90	-	1"	2-1/2"
SM91	SM101	1"	3"
SM92	SM102	1"	5-1/2"
SM93	-	1"	7-1/2"
SM94	SM104	1-1/4"	3"
SM95	-	1-1/4"	5-1/2"
SM96	SM106	1-1/2"	3-1/8"
SM97	SM107	1-3/4"	3-1/4"
SM98	SM108	1-1/8"	2-1/4"
SM99	-	1-1/4"	2-1/4"

**Some rivet/flush sets may require a six-piece minimum order. Please call for availability.**

## .498" to .401" Shank Adapter

For use with 0.498" riveters. This tool makes rivet set inventories interchangeable.

Model MM1951



## Quick Change Safety Retainer

- Safe, fast and easy
- Industry's most popular chisel retainer

The retainer becomes a part of the tool and eliminates the expense and trouble of beehive and quick change springs. Accepts non-turn and turn type tools. **Please specify make and model number of hammer when ordering.**

### 0.401 Shank:

- 0111 Automotive quality
- 3300 Industrial quality

### 0.498 Shank:

- 3200 Industrial quality



Model 3300-10

## Safety Chuck Chisel Holder

New safety feature fits all .401 pneumatic hammers. Tighten chisel holder to lock the chisel firmly in place. Loosen the chisel holder to allow quick change of chisels.

Model 5130



## Needle Scaler Attachment

For most standard 0.401" shank air hammers.  
3mmx19 Replacement Needles

Model SA0204RNS



Part No.	Shank	Fits Tool
0111	0.401	Fits most Michigan Pneumatic models except MP-1010-F & MP-1020-F
3300-1	0.401	All American Pneumatic, Desouter & Superior, Ingersoll-Rand 121, 132, 772, AV10-12-13, Sioux 270-272
3300-9	0.401	Chicago Pneumatic 9311-9315, 711-715, 2X-4X, 4444, Cleco E3-E4-E15-E16, Craftsman 18800, All Dayton, Ingersoll-Rand 115, 116, 117,
3300-10	0.401	All Florida Pneumatic, Snap-On PH45-PH50
3300-U	0.401	Chicago Pneumatic 9311-9315, 711-715, Cleco E3-E4-E15-E16, Craftsman 18800, All Dayton, Ingersoll-Rand 115, 116, 117, Snap-On PH45-PH50, All Florida Pneumatic
3200-1	0.498	Ingersoll-Rand AVC-26
3200-3	0.498	Chicago Pneumatic 4447-717, 5X-9X

# Planishing Hammer Accessories



Michigan Pneumatic

## Planishing Hammer Dies

Form and shape light gauge sheet metal into replacement fenders and body parts using the same industrial grade tools the professionals use. Our planishing hammer parts and accessories are designed to retrofit to an original planishing hammer, or

can be used to build a new unit. The original style hammer mechanism delivers 3000 blows per minute to planish light gauge sheet metal shapes for automobile restoration and race car fabrication. **Replacement dies manufactured from S-5 tool steel.**

### Polished Dies - Upper

Long stem upper die for some CP units



### Special Lower Die



### Polished Dies - Lower



Michigan Pneumatic

## Planishing Hammer Parts

By popular demand, planishing hammer parts to retrofit to an original unit or to build a new hammer. Use the original style hammer mechanism that delivers 3000 blows per minute.



Type 1

Type 2

Type 2 Hammer Case



P070804 Return Spring



P074368 Return Spring



P070528EH Exhaust Deflector

### Complete Assemblies

Part No.	Description	Tool
P072340CP	Type 1 Short Cylinder Complete	CP-528, CP-522 & CP-529
P074365CP	Type 2 Long Cylinder Complete	CP-524-24 & CP-524-36

### Type 1 Short Planishing Hammer Parts

Part No.	Description
P072340	Short Cylinder, Type 1
P072341	Backhead with Narrow Groove
P072342	Cylinder Coupling Sleeve
P072343	Cylinder Lock Spring
P072344	Cylinder Lock Pin (not shown)
P070805	Piston, Type 1
568-022BN70	O-Ring
568-028BN70	O-Ring (requires 3 pieces)
P070804	Return Spring (not included in assembly)
P070528EH	Exhaust Deflector (not included in assembly)

### Type 2 Long Planishing Hammer Parts

Part No.	Description
P074365	Long Cylinder, Type 2
P074367	Backhead with Wide Groove
P072342	Cylinder Coupling Sleeve
P072343	Cylinder Lock Spring
P072344	Cylinder Lock Pin (not shown)
P074366	Piston, Type 2
568-022BN70	O-Ring
568-028BN70	O-Ring (requires 3 pieces)
P074368	Return Spring (not included in assembly)
P070528EH	Exhaust Deflector (not included in assembly)
P074363	Hammer Case (not included in assembly)

# Riveting Hammers, Busters & Accessories



**P001381** Retainer Clip

## Michigan Pneumatic Model MP-60R Riveting Hammer

Medium-duty hammer recommended for riveting work on tanks, steel cars and light structural steel. Powerful, smooth running and easy to hold. **Can be converted to a rivet buster with retainer for using chisels. Parts interchangeable with CP-60, 4689 series riveters.**

Capacity.....	7/8" Hot Rivets	Length.....	17-9/16"
Bore.....	1-1/16"	Weight.....	20.5 lbs.
Piston Stroke.....	7-5/16"	Shank Diameter.....	1.217"
Blows Per Minute.....	1320	Air Inlet Thread.....	3/8"



- 1502** Upper Sleeve
- 1504** Lower Sleeve
- 1505** Rubber Bumper
- 194** Lock Spring
- 190-2.445** Retainer

## Michigan Pneumatic Model MP-80RB Rivet Buster

Powerful rivet buster can be used for cutting large rivets and bolts. Great for heavy-duty chipping in construction applications. Equipped with retainer parts and spring. **Can be converted to a riveter for using rivet sets by removing the retainer accessories and adding a P001381 retainer clip. Parts interchangeable with CP-80, 4689 series riveters.**

Capacity.....	1-1/8" Hot Rivets	Length.....	22"
Bore.....	1-1/16"	Weight.....	24 lbs.
Piston Stroke.....	9-1/2"	Shank Diameter.....	1.217"
Blows Per Minute.....	1200	Air Inlet Thread.....	3/8"



- 2101** Upper Sleeve
- 2103** Lower Sleeve
- 2104** Rubber Bumper
- 194** Lock Spring
- 2190-2.445** Retainer

## Michigan Pneumatic Model MP-90RBHDCC Rivet Buster

Heavy-duty riveter will drive hot rivets up to 1-1/4" diameter. Sizes designed for light and medium riveting work also available. Suited for general construction work and pipe lines. **Can be converted to a riveter for using rivet sets by removing the retainer accessories and adding a P001381 retainer clip. Parts interchangeable with CP-90, 4689 series riveters.**

Capacity.....	1-1/4" Hot Rivets	Length.....	20-9/16"
Bore.....	1-1/16"	Weight.....	23 lbs.
Piston Stroke.....	10"	Shank Diameter.....	1.217"
Blows Per Minute.....	1020	Air Inlet Thread.....	3/8"

## Riveting Hammer Accessories

Fits 1.217 Shank Hammers



### Buttonhead Rivet Sets

Part No.	Rivet Size	Cup Dia. (B)
DEL1502	7/16"	11/16"
DEL1503	1/2"	25/32"
DEL1505	5/8"	1"
DEL1506	11/16"	1-3/32"
DEL1507	3/4"	1-3/16"
DEL1508	13/16"	1-9/32"
DEL1509	7/8"	1-3/8"
DEL15010	15/16"	1-15/32"
DEL15011	1"	1-19/32"
DEL15013	1-1/8"	1-3/4"
DEL15015	1-1/4"	2"

### Flush Rivet Sets

Part No.	Face Dia. (A)
DEL1551	1-1/4"
DEL1552	1-3/8"
DEL1553	1-5/8"
DEL1554	1-3/4"
DEL1555	2"



## Michigan Pneumatic Model MP-4181-USA-NEP

### Rivet Buster

Ideal for cutting large rivets, concrete demolition, and heavy-duty chipping work in maintenance and construction. Features a Boyer spool valve to deliver smooth power in any operating position. **Equipped to accept 2000 series jumbo chisels.** Optional T-handle #0448051-C available. Model MP-4181T-USA-NEP with trenching handle available.



**MADE  
U.S.A.  
IN THE**

- 2101 Upper Sleeve
- 2103 Lower Sleeve
- 2104 Rubber Bumper
- 2194 Lock Spring
- 2190-2.557 Retainer

Capacity.....	1" Rivets	Length.....	26"
Bore.....	1-3/16"	Weight.....	34.5 lbs.
Piston Stroke.....	11"	Shank Diameter.....	1.5"
Blows Per Minute.....	720	Air Inlet Thread.....	3/8"



## Michigan Pneumatic Model MP-4181RB-8

### Rivet Buster

Ideal for cutting large rivets, concrete demolition, heavy-duty chipping work in maintenance and construction. Great for overhead bridge and parking deck concrete repair and demolition work. Features Boyer spool valve to deliver smooth power in any operating position. **Equipped to accept 2000 series jumbo chisels.** Optional T-handle #0448051-C available. Model MP-4181T-8 with trenching handle available.



- 2101 Upper Sleeve
- 2103 Lower Sleeve
- 2104 Rubber Bumper
- 2194 Lock Spring
- 2190-2.557 Retainer

Capacity.....	7/8" Rivets	Length.....	23"
Bore.....	1-3/16"	Weight.....	31.25 lbs.
Piston Stroke.....	8"	Shank Diameter.....	1.5"
Blows Per Minute.....	1080	Air Inlet Thread.....	3/8"



## Michigan Pneumatic Model MP-4181RB

### Rivet Buster

Ideal for cutting large rivets, concrete demolition, and heavy-duty chipping work in maintenance and construction. Features a Boyer spool valve to deliver smooth power in any operating position. **Equipped to accept 2000 series jumbo chisels.** Optional T-handle #0448051-C available. Model MP-4181T with trenching handle available.



- 2101 Upper Sleeve
- 2103 Lower Sleeve
- 2104 Rubber Bumper
- 2194 Lock Spring
- 2190-2.557 Retainer

Capacity.....	1" Rivets	Length.....	26"
Bore.....	1-3/16"	Weight.....	34.5 lbs.
Piston Stroke.....	11"	Shank Diameter.....	1.5"
Blows Per Minute.....	720	Air Inlet Thread.....	3/8"



## Michigan Pneumatic Model MP-RB90-J

### Rivet Buster

Powerful, hard hitting hammer is ideal for cutting bolts and rivet heads. Great for heavy-duty chipping and nail driving. Simple removal of retainer and parts converts tool to a riveter for using rivet sets. **Jumbo Model MP-RB91-J with 1.5" shank comes equipped with 2101, 2103, 2104, 2194 & 2190-2.400 accessories to accept 2000 series jumbo chisels.**



#### MP-RB90-J (only):

- 1502 Upper Sleeve
- 1504 Lower Sleeve
- 1505 Rubber Bumper
- 194 Lock Spring
- 190-2.400 Retainer

Capacity.....	1-1/4" Hot Rivets	Length.....	20-1/4"
Bore.....	1-1/16"	Weight.....	23 lbs.
Piston Stroke.....	9"	Shank Diameter.....	1.217"
Blows Per Minute.....	950	Air Inlet Thread.....	3/8"



**MADE  
U.S.A.  
IN THE**

Michigan Pneumatic **Model MP-633**  
**Model MP-633-NEP**

## Rivet Buster

Ideal for construction, ship building and heavy machinery. Designed to deliver slow, heavy blows. **Equipped to accept 2000 series jumbo chisels.** Model MP-633-NEP features a non-ejectable piston.

- 2101 Upper Sleeve
- 2103 Lower Sleeve
- 2104 Rubber Bumper
- 2194 Lock Spring
- 2190-2.557 Retainer

Capacity.....	3/4"	Length.....	20-1/2"
Bore.....	1-3/16"	Weight.....	27.5 lbs.
Piston Stroke.....	6"	Shank Diameter.....	1.5"
Blows Per Minute.....	1100	Air Inlet Thread.....	3/8"



**MADE  
U.S.A.  
IN THE**

Michigan Pneumatic **Model MP-133**  
**Model MP-133-NEP**

## Rivet Buster

Heavy-duty hammer recommended for steel cars and light structural work. Ideal for bridge deck repair and rivet work on underground tanks. **Equipped to accept 2000 series jumbo chisels.** Model MP-133-NEP features a non-ejectable piston.

- 2101 Upper Sleeve
- 2103 Lower Sleeve
- 2104 Rubber Bumper
- 2194 Lock Spring
- 1851 Retainer

Capacity.....	7/8"	Length.....	22"
Bore.....	1-3/16"	Weight.....	30 lbs.
Piston Stroke.....	8"	Shank Diameter.....	1.5"
Blows Per Minute.....	960	Air Inlet Thread.....	3/8"



**MADE  
U.S.A.  
IN THE**

Michigan Pneumatic **Model MP-1133**  
**Model MP-1133-NEP**

## Rivet Buster

Powerful long stroke hammer has the ability to perform all extra heavy-duty demolition applications. Ideal for cutting large rivets, bolts and underground tanks. **Equipped to accept 2000 series jumbo chisels.** Model MP-1133-NEP features a non-ejectable piston.

- 2101 Upper Sleeve
- 2103 Lower Sleeve
- 2104 Rubber Bumper
- 2194 Lock Spring
- 1851 Retainer

Capacity.....	1"	Length.....	25"
Bore.....	1-3/16"	Weight.....	34 lbs.
Piston Stroke.....	11"	Shank Diameter.....	1.5"
Blows Per Minute.....	850	Air Inlet Thread.....	3/8"



Michigan Pneumatic **Model MP-RB900I-J**  
**Model MP-RB910I-J**

## Rivet Buster

Powerful hammer for concrete demolition, cutting bolts and rivet heads. Additional applications include heavy-duty chipping and nail driving. Features a D-handle with inside trigger and built-in oil reservoir. **Jumbo Model MP-RB910I-J with 1.5" shank comes equipped with 2101, 2103, 2104, 2194 & 2190-2.400 accessories to accept 2000 series jumbo chisels.**

### MP-RB900I-J (only):

- 1502 Upper Sleeve
- 1504 Lower Sleeve
- 1505 Rubber Bumper
- 194 Lock Spring
- 190-2.400 Retainer

Capacity.....	1-1/4"	Length.....	20-1/2"
Bore.....	1-1/16"	Weight.....	24 lbs.
Piston Stroke.....	9"	Shank Diameter.....	1.217"
Blows Per Minute.....	900	Air Inlet Thread.....	3/8"

# Rivet Buster Accessories



## Rivet Buster Chisels 1500 series and 2000 series chisels and accessories

Standard Chisel		for cutting loose rivets
Moil Point		for concrete demolition
Side Cut Chisel		for busting heads off tight rivets
Ripper		for all cutting operations
Back Out Punch		for backing out tight rivets
Long Clearance Back Out Punch		for long clearance punches

Type	Length	1500 Series Heavy-Duty	2000 Series Jumbo Extra Heavy-Duty
Standard Chisel	9"	1506	2005
	12"	1506-12	2005-12
	18"	1506-18	2005-18
Moil Point	9"	1512	2011
	12"	1512-12	2011-12
	18"	1512-18	2011-18
Side Cut Chisel	9"	1507	2006
	12"	1507-12	2006-12
	18"	1507-18	2006-18
Ripper	9"	1511	2010
3/8" Back Out Punch	9"	1515	-
1/2" Back Out Punch	9"	1516	2019
	9"	1524-4LC	-
	11"	1524-6LC	-
	13"	1524-8LC	-
5/8" Back Out Punch	9"	1508	2007
	9"	1520-4LC	2024-4LC
	11"	1520-6LC	2024-6LC
	13"	1520-8LC	2024-8LC
3/4" Back Out Punch	9"	1509	2008BP
	9"	1521-4LC	2025-4LC
	11"	1521-6LC	2025-6LC
	13"	1521-8LC	2025-8LC
7/8" Back Out Punch	9"	1510	2009
	9"	1522-4LC	2026-4LC
	11"	1522-6LC	2026-6LC
	13"	1522-8LC	2026-8LC
1" Back Out Punch	9"	1517	2020
	9"	1525-4LC	2028-4LC
	11"	1525-6LC	2028-6LC
	13"	1525-8LC	2028-8LC
1-1/8" Back Out Punch	9"	-	2021BP
	9"	-	2029-4LC
	11"	-	2029-6LC
	13"	-	2029-8LC



2000 Series Side Cut Chisel

Type	Length	Model No.
Side Cut Chisel	9"	276-AC



2000 Series Non-Sparking Ripper

Type	Length	Model No.
Non-Sparking Ripper	9-1/2"	295BC



2000 Series Wide Chisels

Type	Length	Model No.
2-1/2" Wide Chisel	15"	5602



Rail Road Spike Driver

Type	Length	Model No.
1-1/2" Shank Spike Driver	8"	115SD

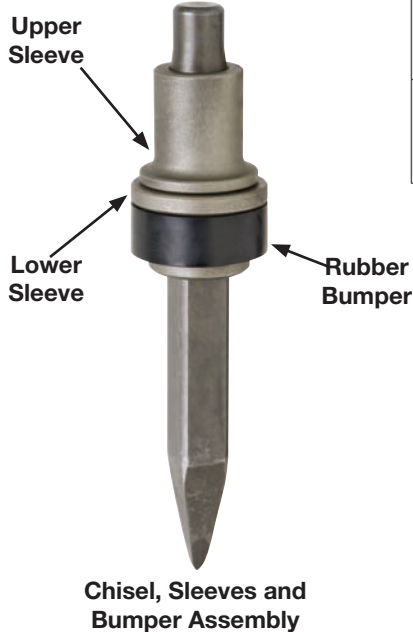

### Retainer Parts



1500 Series Replacement Retainer Parts	
Type	Model No.
Safety Retainer	190 Series
Lock Spring	194
Upper Sleeve	1502
Lower Sleeve	1504
Lower Sleeve (split)	1504S
Rubber Bumper	1505
Poly Bumper	1505P

2000 Series Replacement Retainer Parts	
Type	Model No.
Safety Retainer	2190 Series
Lock Spring	2194
Upper Sleeve	2101
Lower Sleeve	2103
Lower Sleeve (split)	2103S
Rubber Bumper	2104
Poly Bumper	2104P

### #2035 Conversion Kit

Converts all rivet busters with 190 retainer to take 2000 Series jumbo extra heavy-duty tools without a new hammer or retainer.

Description	Model No.
Upper Sleeve	2000
Lower Sleeve	2003
Rubber Bumper	1505
Complete Kit	2035

### Rivet Buster Retainers - for other manufacturers

Model No.	Fits Tool	"B"
190-2.400	Jet RB-90, MP-RB90-J	2.400"
190-2.445	CP-40, 50, 60, 80, 90	2.445"
2190-2.557	CP-4181, MP-4181	2.557"
2190-2.565	Toku RB-110	2.565"
2190-2.400	Jet RB-91, MP-RB91-J	2.400"
2190-2.445	CP-40, 50, 60, 80, 90	2.445"
2190-2.385	Thor-11RB, Kent 800, 1100	2.385"
190-2.385	Thor-53, 63, 83, 93	2.385"
1851	APT-133, Thor-283	2.610"
9001-200	IR-9001	2.500"



Any rivet hammer can be converted to a rivet buster by grooving barrel and adding retainer parts. Please specify make and model of hammer when ordering retainer.

# Pick & 4-Bolt Chipping Hammers



1190-SUL1  
1194-2

Retainer  
Retainer Spring

MADE  
**U.S.A.**  
IN THE

Michigan Pneumatic **Model MP-CH2R - Round**  
**Model MP-CH2H - Hex**

## Heavy-Duty Chipping Hammer

Four bolt design eliminates handle breakage. Includes chisel retainer and chisel retainer spring. **Aluminum handle model available. Most parts interchangeable with Sullair CH series chipping hammers.**

Blows Per Minute .....	2300	Length .....	14"
Stroke.....	3"	Weight.....	17 lbs.
Bore.....	1-1/8"	Air Inlet Thread .....	1/2"
Shank Diameter: .....	.580H/.680R	Avg. Air Consumption .....	26 cfm



1190-SUL1  
1194-2

Retainer  
Retainer Spring

MADE  
**U.S.A.**  
IN THE

Michigan Pneumatic **Model MP-CH3R - Round**  
**Model MP-CH3H - Hex**

## Heavy-Duty Chipping Hammer

Four bolt design eliminates handle breakage. Includes chisel retainer and chisel retainer spring. **Aluminum handle model available. Most parts interchangeable with Sullair CH series chipping hammers.**

Blows Per Minute .....	2100	Length .....	15-1/4"
Stroke.....	3-3/4"	Weight.....	18.5 lbs.
Bore.....	1-1/8"	Air Inlet Thread .....	1/2"
Shank Diameter: .....	.580H/.680R	Avg. Air Consumption .....	30 cfm



1190-SUL1  
1194-2

Retainer  
Retainer Spring

MADE  
**U.S.A.**  
IN THE

Michigan Pneumatic **Model MP-CH4R - Round**  
**Model MP-CH4H - Hex**

## Heavy-Duty Chipping Hammer

Four bolt design eliminates handle breakage. Includes chisel retainer and chisel retainer spring. **Aluminum handle model available. Most parts interchangeable with Sullair CH series chipping hammers.**

Blows Per Minute .....	1700	Length .....	16-1/2"
Stroke.....	4-1/4"	Weight.....	19.5 lbs.
Bore.....	1-1/8"	Air Inlet Thread .....	1/2"
Shank Diameter: .....	.580H/.680R	Avg. Air Consumption .....	33 cfm



CP-4100-2R

Chicago Pneumatic **Model CP-4100-2R - Round**  
**Model CP-4100-2H - Hex**

## Pick Hammer

Ideal for metal removal in foundries, petro-chemical plants, fabrication shops and shipyards. Features a simplate valve for smooth, powerful operation. **Uses round collar moil points and narrow chisels only.**

Blows Per Minute .....	3000	Length .....	13"
Stroke.....	2-1/2"	Weight.....	5.25 lbs.
Bore.....	3/4"	Air Inlet Thread .....	3/8"
Shank Diameter: .....	0.580H/0.680R	Avg. Air Consumption .....	16 cfm



Chicago Pneumatic **Model CP-4100-3H - Hex**

## Pick Hammer

Powerful, lightweight tool is ideal for use in horizontal and overhead demolition of concrete, stone and masonry structures. Also well suited for metal removal in foundries, petro chemical plants, fabrication shops and shipyards. Features a simplate valve for smooth, powerful operation. **Uses round collar 0.580 hex shank moil points and narrow chisels only.**

Blows Per Minute .....	2500	Length .....	15"
Stroke.....	3-1/2"	Weight.....	6.125 lbs.
Bore.....	3/4"	Air Inlet Thread .....	3/8"
Shank Diameter: .....	0.580H	Avg. Air Consumption .....	16 cfm

# Retainer Type Chipping Hammers



Michigan Pneumatic **Model MP-4113R - Round**  
**Model MP-4113H - Hex**

## Mini Chipping Hammer

Compact, lightweight chipping hammer designed for working in tight spaces or small enclosures. Smooth throttle, easy to hold, and powerful for its size. **Please specify hex or round shank.**

1190-1.655 Retainer  
1194-2 Retainer Spring

Blows Per Minute .....	3200	Length w/Retainer .....	12-3/4"
Stroke .....	1.8"	Weight w/Retainer .....	7.9 lbs.
Bore .....	0.88"	Air Inlet Thread .....	3/8"



Michigan Pneumatic **Model MP-1100R - Round**  
**Model MP-1100H - Hex**

## Retainer Chipping Hammer

Lightweight, durable, medium-duty tools designed for cleaning castings, bushing concrete, and cutting or chipping masonry materials of all types. Ideal for shipyards, foundries and contractors. **Parts are interchangeable with CP-9362, 3 and 4 series chippers. Please specify hex or round shank.**

1190-MPT1 Retainer  
1194-2 Retainer Spring

Blows Per Minute .....	2800	Length w/Retainer .....	13-1/2"
Stroke .....	1"	Weight w/Retainer .....	14.75 lbs.
Bore .....	1-1/8"	Air Inlet Thread .....	3/8"



Michigan Pneumatic **Model MP-2200R - Round**  
**Model MP-2200H - Hex**

## Retainer Chipping Hammer

Lightweight, durable, medium-duty tools designed for cleaning castings, bushing concrete, and cutting or chipping masonry materials of all types. Ideal for shipyards, foundries and contractors. **Parts are interchangeable with CP-9362, 3 and 4 series chippers. Please specify hex or round shank.**

1190-MPT1 Retainer  
1194-2 Retainer Spring

Blows Per Minute .....	2150	Length w/Retainer .....	15-1/2"
Stroke .....	2"	Weight w/Retainer .....	15.75 lbs.
Bore .....	1-1/8"	Air Inlet Thread .....	3/8"



Michigan Pneumatic **Model MP-3300R - Round**  
**Model MP-3300H - Hex**

## Retainer Chipping Hammer

Ideal for medium to heavy-duty chipping jobs. Great for paper stripping and weld destruct applications. Heat treated pistons and barrels resist wear and add longevity. **Parts are interchangeable with CP-9362, 3 and 4 series chippers. Please specify hex or round shank.**

1190-MPT1 Retainer  
1194-2 Retainer Spring

Blows Per Minute .....	1900	Length w/Retainer .....	16-1/4"
Stroke .....	3"	Weight w/Retainer .....	16.40 lbs.
Bore .....	1-1/8"	Air Inlet Thread .....	3/8"



Michigan Pneumatic **Model MP-4400R - Round**  
**Model MP-4400H - Hex**

## Retainer Chipping Hammer

Features a cast steel handle for long life and operator comfort. Designed for heavy-duty jobs where power and reliability are a must. Great for demolition, riveting and cutting steel. **Parts are interchangeable with CP-9362, 3 and 4 series chippers. Please specify hex or round shank.**

1190-MPT1 Retainer  
1194-2 Retainer Spring

Blows Per Minute .....	1500	Length w/Retainer .....	18-1/4"
Stroke .....	4"	Weight w/Retainer .....	17.70 lbs.
Bore .....	1-1/8"	Air Inlet Thread .....	3/8"



# Industrial Chipping Hammers



MADE  
U.S.A.  
IN THE

1190-1.655  
1194-2

Retainer  
Retainer Spring

Michigan Pneumatic **Model MP-K2LR-RET - Round**  
**Model MP-K2LH-RET - Hex**

## Chipping Hammer

Smallest line of chippers featuring standard .580 hex or .680 round shank bushing. **Parts interchangeable with Ingersoll-Rand K2L models. Please specify hex or round shank.**

Blows Per Minute .....	3600	Length .....	12"
Stroke.....	1-3/4"	Weight.....	8 lbs.
Bore.....	7/8"	Air Inlet Thread .....	1/4"



1190-MPT1  
1194-2

Retainer  
Retainer Spring

Michigan Pneumatic **Model MP-100CR-RET - Round**  
**Model MP-100CH-RET - Hex**

## Retainer Chipping Hammers

Powerful, lightweight tools available in four sizes for chipping, beading, cleaning castings, cutting, and roughening concrete and masonry. Designed for rugged use in any application. **Parts are interchangeable with Chicago Pneumatic Simplate chippers. Please specify hex or round shank.**

Blows Per Minute .....	2800	Length w/Retainer .....	13-3/4"
Stroke.....	1"	Weight w/Retainer .....	14.00 lbs.
Bore.....	1-1/8"	Air Inlet Thread .....	3/8"



1190-MPT1  
1194-2

Retainer  
Retainer Spring

Michigan Pneumatic **Model MP-200CR-RET - Round**  
**Model MP-200CH-RET - Hex**

## Retainer Chipping Hammers

Excellent for chipping, scaling, cleaning work on castings, billets and paper box stripping. Smooth throttle characteristics, easy to hold, powerful for its size. Simplate valve design provides excellent controllability. **Parts are interchangeable with Chicago Pneumatic Simplate chippers. Please specify hex or round shank.**

Blows Per Minute .....	2200	Length w/Retainer .....	14-1/2"
Stroke.....	2"	Weight w/Retainer .....	14.90 lbs.
Bore.....	1-1/8"	Air Inlet Thread .....	3/8"



1190-MPT1  
1194-2

Retainer  
Retainer Spring

Michigan Pneumatic **Model MP-300CR-RET - Round**  
**Model MP-300CH-RET - Hex**

## Retainer Chipping Hammers

Deliver fast, powerful blows and produce maximum energy with minimal tool weight for medium to extra heavy-duty chipping. Virtually trouble free Simplate valve design. Rugged design for all heavy-duty chipping applications. **Parts are interchangeable with Chicago Pneumatic Simplate chippers. Please specify hex or round shank.**

Blows Per Minute .....	1700	Length w/Retainer .....	16-1/2"
Stroke.....	3"	Weight w/Retainer .....	17.10 lbs.
Bore.....	1-1/8"	Air Inlet Thread .....	3/8"



1190-MPT1  
1194-2

Retainer  
Retainer Spring

Michigan Pneumatic **Model MP-400CR-RET - Round**  
**Model MP-400CH-RET - Hex**

## Retainer Chipping Hammers

Streamlined design for heavy riveting, chipping, scaling, beading. Many different uses, including paper box stripping and cutting defective welds. Designed for rugged use in foundries and construction applications. **Parts are interchangeable with Chicago Pneumatic Simplate chippers. Please specify hex or round shank.**

Blows Per Minute .....	1450	Length w/Retainer .....	17-3/4"
Stroke.....	4"	Weight w/Retainer .....	18.00 lbs.
Bore.....	1-1/8"	Air Inlet Thread .....	3/8"

# Chipping Hammer Chisels



## Oval Collar Shank Style



.680 Round



.580 Hex

MPT chisels are manufactured from the finest alloys available for **Michigan Pneumatic** retainer type chippers, as well as other manufacturers chippers. Each chisel is hardened and tempered throughout to provide maximum strength and resistance to fatigue, then carefully inspected to meet the rigid MPT quality standards.

Round collar shank style chisels are also available. Longer lengths up to 72" are available. Please specify part number when ordering.

Blade Style			Oval Collar Retainer Type					
			9"	12"	18"	24"	36"	48"
Blank		Round	301	301-12	301-18	301-24	301-36	301-48
		Hex	302	302-12	302-18	302-24	302-36	302-48
3/4" Flat Chisel		Round	303	303-12	303-18	303-24	303-36	303-48
		Hex	304	304-12	304-18	304-24	304-36	304-48
Moil Point		Round	313MP	315	315-18	315-24	315-36	315-48
		Hex	314MP	316	316-18	316-24	316-36	316-48
2" Wide Scaling Chisel		Round	323WC	323-12	323-18	323-24	323-36	323-48
		Hex	324	324-12	324-18	324-24	324-36	324-48
2-1/2" Non-Sparking Chisel		Round	323-BC	-	-	-	-	-
		Hex	-	-	-	-	-	-
3" Wide Scaling Chisel		Round	323-3	323-12-3	-	-	-	-
		Hex	324-3	324-12-3	-	-	-	-
5" Wide Scaling Chisel		Round	FO3805	-	-	-	-	-
		Hex	GO3805	-	-	-	-	-
Cape		Round	305	305-12	-	-	-	-
		Hex	306	306-12	-	-	-	-
Round Nose		Round	307	307-12	-	-	-	-
		Hex	308	308-12	-	-	-	-
Diamond Point		Round	309	309-12	-	-	-	-
		Hex	310	310-12	-	-	-	-
Bushing Tool		Round	50100	-	-	-	-	-
		Hex	50200BT	-	-	-	-	-
Gouge		Round	337	337-12	-	-	-	-
		Hex	338	338-12	-	-	-	-

# Chipping Hammer Accessories



## 1190 Series Solid Type Chisel Retainers



For use where frequent change of chisels is not required. Retainer must be removed from hammer barrel to change chisels. To remove retainer from hammer barrel, pull 1194 series lock spring entirely out of slot in retainer and slide retainer off barrel.

Available To Fit The Following Brands And Models:

### Michigan Pneumatic

Tool Model No.	Part Number
MP-100 thru MP-400 series	1190-MPT1
MP-1100 thru MP-4400 series	1190-MPT1
MP-CH2 thru MP-CH4 series	1190-SUL1
MP-K2L series	1190-1.655
MP-4113 series	1190-1.655

### Chicago Pneumatic

Tool Model No.	Part Number
CP-1-RV thru CP-4-RV Series	1190-CPT2
CP-1 CP-2A CP-3 CP-4 CP-9362 CP-9363 CP-9364	1190-CPT1
CP-4113	1190-1.692

### Ingersoll-Rand

Tool Model No.	Part Number
IR-K2L	1190-1.655
IR-1 IR-2 & IR-200 IR-2A IR-3 & IR-300 IR-3A IR-4 & IR-400	1190-IRC1
IR-W1 thru IR-W4 Series	1193

## Hitch Cutter Retainer

Designed for both oval collar and round collar tools in any width blades.



1195-MPT1

## Michigan Pneumatic 1191-MPT1 Quick Change



## 1192-MPT1 Rapid Change

For use where frequent tool change is necessary. It is not necessary to remove retainer from hammer barrel to change tools. On the 1191 retainer, the chisel is changed by lifting the end of flat spring on outside of retainer to release lock pin, rotate tool 1/4 turn, remove tool. Insert new tool and rotate 1/4 turn. On the 1192 retainer, it is **not** necessary to lift the spring, simply rotate the chisel 1/4 turn and remove to change.

## Replacement Rotating Insert & Retaining Ring

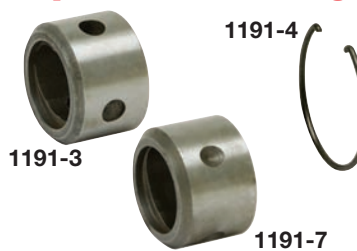

**1191-3** for use with 1191 Quick Change series retainer  
**1191-7** for use with 1192 Rapid Change series retainer  
**1191-4** for retaining the rotating insert on both 1191 and 1192 series retainers.

## Replacement Flat Spring & Pin



**1191-2** for use with 1191 Quick Change series retainer  
**1191-6** for use with 1192 Rapid Change series retainer

## Lock Spring for All Retainers



**1194-2** Heavy-Duty Wire Spring

**1194-5** Solid Urethane Lock Spring

## Deluxe Ball Type Chisel Retainer

Designed for rapid change of tools without removing retainer from barrel. Tool is quickly changed by pulling back sleeve to unlock tool in retainer. Releasing sleeve back to normal position locks tool in retainer. Takes both oval collar and round collar tools in any width blades.



**1291-1** Sleeve  
**1291-2** Spring  
**1291-3** Balls (set of 6)  
**1291-4** Retainer Clip  
**1194-2** Heavy-Duty Lock Spring

**1291-MPT1**  
**1291-IRC2**  
**1291-SUL2**  
**1291-1.942**

OSHA regulations specify that retainers shall be used to prevent accidental expulsion of tools. Retainers are available for all models of chipping hammers. Please specify model of chipping hammer when ordering. All accessories are made in U.S.A.

# Chipping Hammers



Michigan Pneumatic

## W-Style Chipping Hammer

When conventional tapered style retainer chippers fail prematurely, the acme thread style chipping hammers are put into service. The heavy-duty retainer mechanism has two sets of steel sleeves and a rubber bumper to disperse and absorb the blows of the chisel. W-style chippers use oval or round collar chisels. See page 112 for additional accessories. Please specify hex or round shank.



**MP-W4R**  
Chipping Hammer (sold with retainer)

### Chipping Hammer Retainer & Parts

<b>HHW1-300</b> Retainer	<b>HHW1-213</b> Lower Washer	<b>R00A2-103</b> O-Ring	<b>24SR-207</b> Retainer Spring	<b>H3R-31</b> Upper Washer	<b>H3R-203</b> Rubber Bumper

### Chipping Hammers

Model No.	Blows Per Minute	Stroke	Bore	Length	Weight	Rec'd Hose Size	Air Inlet	Avg. Air Consumption
MP-W1R MP-W1H	2500	1"	1-1/8"	15-7/8"	14.75 lbs.	1/2"	3/8"	28 cfm
MP-W2R MP-W2H	2300	2"	1-1/8"	16-3/8"	15.50 lbs.	1/2"	3/8"	28 cfm
MP-W3R MP-W3H	1725	3"	1-1/8"	18-1/4"	16.60 lbs.	1/2"	3/8"	29 cfm
MP-W4R MP-W4H	1480	4"	1-1/8"	19-1/4"	17.50 lbs.	1/2"	3/8"	29 cfm



### Michigan Pneumatic Model MP-3000C-U Core Knock-Out Tool

Designed to remove or rattle sand, shell cores or molds from castings. Equipped with anvil, retainer and mounting brackets.

**300016** Mounting Bracket Complete

Blows Per Minute .....	1700	Length w/Retainer .....	14"
Stroke .....	3"	Weight w/Mount .....	21.75 lbs.
Bore .....	1-1/8"	Air Inlet Thread .....	3/8"



### Michigan Pneumatic Model MP-MA1R - Round Model MP-MA1H - Hex

#### Chipping Hammer

You cannot afford to do overhead concrete repair work or chipping without one. Lightweight chipper for heavy-duty jobs. **Parts interchangeable with MasterPower or Black & Decker models.** Please specify hex or round shank.

Blows Per Minute .....	2800	Length w/ Retainer .....	11-7/8"
Stroke .....	1"	Weight w/ Retainer .....	12.5 lbs.
Bore .....	1-1/8"	Air Inlet Thread .....	3/8"

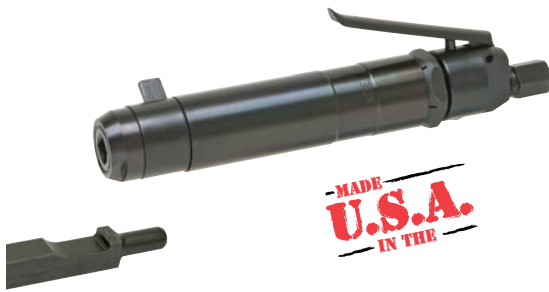

**MADE  
U.S.A.  
IN THE**

Style 200 chisel

## Michigan Pneumatic Model MP-1BL

### Scaling Hammer - Lever Throttle

New, improved design features smooth action throttling characteristics. Easy to handle, powerful tool widely used as a general purpose hammer for chipping stone, metal, concrete, brick and for carving wood. Chisels are held firmly in place and cannot rotate. Chisels easily changed with a quick release lever. **Parts interchangeable with Cleco B1A scaler.**

Takes style 200 - 1/2" square chisel.

Bore.....	1"	Length.....	10-1/4"
Stroke.....	1-1/8"	Weight.....	3.625 lbs.
Blows Per Minute.....	4600	Air Inlet Thread.....	1/4"
Rec'd Hose Size.....	1/4"	Avg. Air Consumption.....	6 cfm

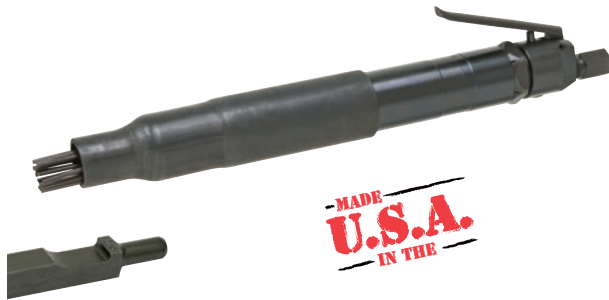

**MADE  
U.S.A.  
IN THE**

Style 200 chisel

## Michigan Pneumatic Model MP-1BLNS

### Needle Scaler - Lever Throttle

Excellent for removing weld splatter, rust, paint and other debris from many different and unusual surfaces and in hard-to-reach places. Ideal for construction sites, fabrication shops, refineries and foundries. **Parts interchangeable with Cleco Model B1A scaler.**

1392 Needle Attachment

Takes style 200 - 1/2" square chisel.

Bore.....	1"	Length.....	17"
Stroke.....	1-1/8"	Weight.....	6.2 lbs.
Blows Per Minute.....	4600	Air Inlet Thread.....	1/4"
Rec'd Hose Size.....	1/4"	Avg. Air Consumption.....	12 cfm



**MADE  
U.S.A.  
IN THE**

Style 100 chisel

## Michigan Pneumatic Model MP-182L

### Scaling Hammer - Lever Throttle

Ideal for removing weld splatter, rust, scale and debris from hard to reach surfaces. Useful in oil fields, fabrication shops, petro-chemical plants and foundries. **Gooseneck handle and push throttle hammers also available. Parts interchangeable with Ingersoll-Rand Model 182.**

Takes style 100 - 1/2" quarter octagon chisel.

Bore.....	15/16"	Length.....	9"
Stroke.....	1-1/16"	Weight.....	4.00 lbs.
Blows Per Minute.....	4000	Air Inlet Thread.....	1/4"
Rec'd Hose Size.....	1/4"	Avg. Air Consumption.....	13 cfm



**MADE  
U.S.A.  
IN THE**

Style 100 chisel

## Michigan Pneumatic Model MP-182LNS

### Needle Scaler - Lever Throttle

Useful in oil fields, fabrication shops, petro-chemical plants and foundries. Ideal for removing weld splatter, rust, scale and debris from hard to reach surfaces. **Push throttle hammers also available. Parts interchangeable with Ingersoll-Rand Model 182.**

1393 Needle Attachment

Takes style 100 - 1/2" quarter octagon chisel.

Bore.....	15/16"	Length.....	17"
Stroke.....	1-1/16"	Weight.....	5.75 lbs.
Blows Per Minute.....	4000	Air Inlet Thread.....	1/4"
Rec'd Hose Size.....	1/4"	Avg. Air Consumption.....	13 cfm

# Cleco-Style Industrial Scalers



Style 200 chisel

**MADE  
U.S.A.  
IN THE**



MP-1BL-SBKHD

## Michigan Pneumatic Model MP-1BL-COKE OVEN

### Coke Oven Scaler - Non-Revolving Push Throttle

Designed to be attached to long air pipes to remove debris from oven bricks used in the steel industry. Features a simple push throttle. **Model MP-1BL-SBKHD with solid back head available.**

Takes style 200 - 1/2" square chisel.

Bore.....	1"	Length.....	12-1/2"
Stroke.....	1-1/8"	Weight.....	4.5 lbs.
Blows Per Minute .....	4600	Air Inlet Thread .....	1/2"
Rec'd Hose Size .....	1/4"	Avg. Air Consumption .....	6 cfm



Style 200 chisel

**MADE  
U.S.A.  
IN THE**

## Michigan Pneumatic Model MP-P-1BL

### Scaling Hammer - Push Throttle

Popular scaling hammer for its high speed action, short length and light weight. Widely used for light chipping, caulking and scaling in steel mills, foundries and assembly shops. Ideal for close quarter work. **Parts interchangeable with Cleco B1A scaler. Model MP-P-1SR-1392 needle scaler available.**

1392 Needle Attachment

Takes style 200 - 1/2" square chisel.

Bore.....	1"	Length.....	12"
Stroke.....	1-1/8"	Weight.....	3.75 lbs.
Blows Per Minute .....	4600	Air Inlet Thread .....	1/4"
Rec'd Hose Size .....	1/4"	Avg. Air Consumption .....	6 cfm



Style 200 chisel

## Michigan Pneumatic Model MP-G-1SR

### Scaling Hammer - Gooseneck Throttle

Designed for long-term scaling jobs, featuring a strategically positioned, ergonomic handle for comfortable operation. The handle allows the operator's wrist to function in natural position, reducing fatigue. **Parts interchangeable with Cleco B1-A-BV. Model MP-G-1SR-1392 needle scaler available.**

1392 Needle Attachment

Takes style 200 - 1/2" square chisel.

Bore.....	1"	Length.....	11-1/2"
Stroke.....	1-1/8"	Weight.....	3.75 lbs.
Blows Per Minute .....	4600	Air Inlet Thread .....	1/4"
Rec'd Hose Size .....	1/4"	Avg. Air Consumption .....	6 cfm



Style 200 chisel

## Michigan Pneumatic Model MP-PG-1SR

### Scaling Hammer - Offset Grip Throttle

A built-in power regulator allows the operator to adjust the hitting power to prevent damage to softer castings and surfaces. Cleans rust, scale, paint and other coatings from nearly any surface. **Parts interchangeable with Cleco B1-A-BV. Model MP-PG-1SR-1392 needle scaler available.**

1392 Needle Attachment

Takes style 200 - 1/2" square chisel.

Bore.....	1"	Length.....	10-3/4"
Stroke.....	1-1/8"	Weight.....	5 lbs.
Blows Per Minute .....	4600	Air Inlet Thread .....	1/4"
Rec'd Hose Size .....	1/4"	Avg. Air Consumption .....	6 cfm

# CP Ball-Type Style Industrial Scalers



## Michigan Pneumatic Model MP-L-455C

### Scaling Hammer - Lever Throttle

Controlled by a lever type throttle. Squeeze lever for hammer action. Very powerful for its capacity. Good for removing flux and spatter after welding. Equipped with a ball type retainer. **Parts interchangeable with Cleco BR scaler. Model MP-L-455C-1394 needle scaler available. Model MP-455-LR long reach scaler available.**

1394 Needle Attachment

Takes style 100 - 1/2" quarter octagon chisel.

Bore.....	1"	Length.....	10-3/8"
Stroke.....	1-1/8"	Weight.....	4 lbs.
Blows Per Minute.....	4200	Air Inlet Thread.....	1/4"
Rec'd Hose Size.....	1/4"	Avg. Air Consumption.....	6 cfm



Style 100 chisel



## Michigan Pneumatic Model MP-P-455C

### Scaling Hammer - Push Throttle

Controlled by a push type throttle. Push the throttle for hammer action. Widely used for scaling and chipping in shipyards and machine shops. Also used for light scale removal on airplanes and for ironing sheet metal. **Parts interchangeable with Cleco BR scaler. Model MP-P-455C-1394 needle scaler available.**

1394 Needle Attachment

Takes style 100 - 1/2" quarter octagon chisel.

Bore.....	1"	Length.....	12-1/8"
Stroke.....	1-1/8"	Weight.....	4 lbs.
Blows Per Minute.....	4200	Air Inlet Thread.....	1/4"
Rec'd Hose Size.....	1/4"	Avg. Air Consumption.....	6 cfm



Style 100 chisel



## Michigan Pneumatic Model MP-G-455C

### Scaling Hammer - Gooseneck Throttle

Features power for the heaviest scaling jobs and an ergonomic handle to reduce operator fatigue and increase production. Outstanding for scaling castings and removing paint or rust. **Model MP-G-455C-1394 needle scaler available.**

1394 Needle Attachment

Takes style 100 - 1/2" quarter octagon chisel.

Bore.....	1"	Length.....	12-7/8"
Stroke.....	1-1/8"	Weight.....	3.875 lbs.
Blows Per Minute.....	4200	Air Inlet Thread.....	1/4"
Rec'd Hose Size.....	1/4"	Avg. Air Consumption.....	6 cfm



Style 100 chisel



## Michigan Pneumatic Model MP-PG-455C

### Scaling Hammer - Offset Grip Throttle

Features an offset handle for operator comfort and single finger operation. Ideal for scaling rust removal, peening and tank cleaning. **Model MP-PG-455C-1394 needle scaler available.**

1394 Needle Attachment

Takes style 100 - 1/2" quarter octagon chisel.

Bore.....	1"	Length.....	10"
Stroke.....	1-1/8"	Weight.....	5.5 lbs.
Blows Per Minute.....	4600	Air Inlet Thread.....	1/4"
Rec'd Hose Size.....	1/4"	Avg. Air Consumption.....	6 cfm



Style 100 chisel

# Long Reach Scalers



Michigan Pneumatic **Model MP-1SR-LR**

## Long Reach Scaler

Easy to handle, powerful tool widely used as a general purpose hammer for chipping stone, metal, concrete, brick and carving wood.

**HG-37412** Stopper  
**HG-37213** Cushion Seat

**HG-37434** Stopper Spring  
**390-3** 3" Wide Chisel



Style 200 - 1/2" square chisel



Chisel not included

Bore.....	1"	Length.....	.52"
Stroke.....	1-1/8"	Weight.....	14 lbs.
Blows Per Minute.....	4600	Air Inlet Thread.....	1/2"
Rec'd Hose Size.....	3/8"	Avg. Air Consumption.....	6 cfm

Michigan Pneumatic **Model MP-2LRCS**

## Long Reach Scaler

Ideal for tile, glue, resin, grease and paint removal. Hits twice as hard as a regular scaler.

**389** 2" Wide Chisel

**389-3** 3" Wide Chisel



Style 300 chisel - 1/2" quarter octagon chisel



Includes 3" Wide Chisel

Bore.....	15/16"	Length.....	48" or 60"
Stroke.....	2"	Weight.....	14 lbs.
Blows Per Minute.....	3400	Air Inlet Thread.....	1/2"
Rec'd Hose Size.....	1/2"	Avg. Air Consumption.....	12 cfm

MADE U.S.A. IN THE

Michigan Pneumatic **Model MP-2200R-LR - Round**  
**Model MP-2200H-LR - Hex**

## Long Reach Scaler

Hits twice as hard as a regular scaler. Ideal for tile, paint, glue, resin, barnacle and heavy scale removal. **Please specify hex or round shank.**

**FO3805** Round Shank 5" Wide Chisel  
**GO3805** Hex Shank 5" Wide Chisel  
**1190-MPT1** Retainer  
**1194-2** Retainer Spring



Chisel not included

Bore.....	1-1/8"	Length.....	.54"
Piston Stroke.....	2"	Weight.....	26.25 lbs.
Blows Per Minute.....	2150	Air Inlet Thread.....	1/2"
Rec'd Hose Size.....	1/2"	Avg. Air Consumption.....	10 cfm

Michigan Pneumatic **Model MP-CH3R-LR - Round**  
**Model MP-CH3H-LR - Hex**

## Long Reach Scaler

Powerful tool for chipping, beading, cleaning castings, cutting, and roughening concrete and masonry. Designed for rugged use in any application. **Please specify hex or round shank.**

**FO3805** Round Shank 5" Wide Chisel  
**GO3805** Hex Shank 5" Wide Chisel  
**1190-SUL1** Retainer  
**1194-2** Retainer Spring

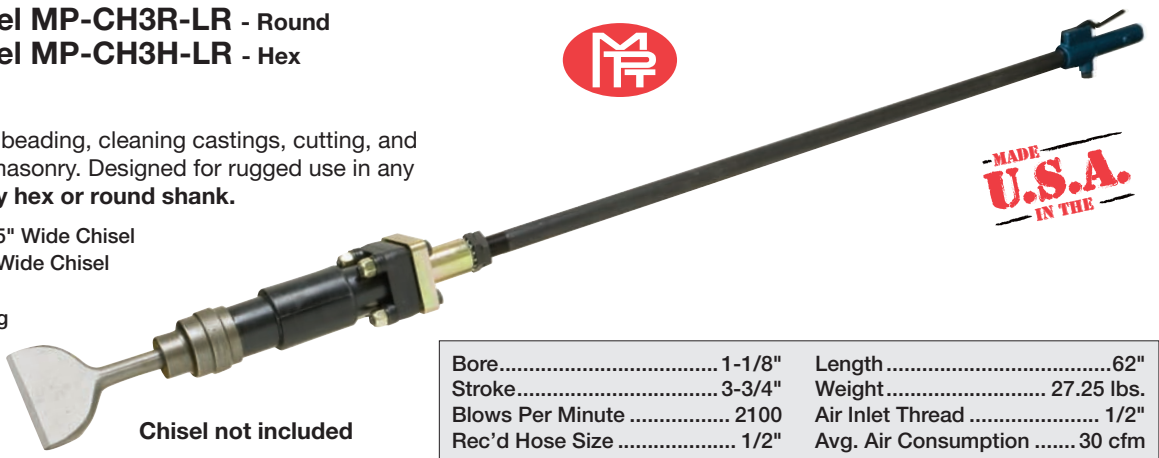

Chisel not included

Bore.....	1-1/8"	Length.....	.62"
Stroke.....	3-3/4"	Weight.....	27.25 lbs.
Blows Per Minute.....	2100	Air Inlet Thread.....	1/2"
Rec'd Hose Size.....	1/2"	Avg. Air Consumption.....	30 cfm

MADE U.S.A. IN THE





# Weldflux Scaler Chisels & Accessories

## Style 100

1/2" Quarter Octagon Stock



Designed for: Michigan Pneumatic Models MP-L-455C & MP-P-455C, Chicago Pneumatic, Thor, Ingersoll-Rand (172 & 182), Rockwell, ARO and Sioux scalers.

## Style 200

1/2" Square Stock



Designed for: Michigan Pneumatic Models MP-L-1SR & MP-P-1SR, Chicago Pneumatic (9356), Ingersoll-Rand (183), Cleco, ARO and Rotor scalers.

## Style 300

1/2" Quarter Octagon Stock



Designed for: Master Power and Black & Decker scalers.

Blade Style		Length	Width of Cut	Style 100	Style 200	Style 300
Blank Chisel		7"	-	395	391	385
		12"		395-12	391-12	385-12
		18"		395-18	391-18	385-18
Narrow Flat Chisel		7"	3/4"	396	392	386
		12"		396-12	392-12	386-12
		18"		396-18	392-18	386-18
Wide Scaling Chisel		7"	1-3/8"	397	393	387
		12"		397-12	393-12	387-12
		18"		397-18	393-18	387-18
Angle Scaling Chisel		7"	1-3/8"	398	394	388
		12"		398-12	394-12	388-12
		18"		398-18	394-18	388-18
2" Scraper & 3" Scraper		7"	2" 3"	399	390	389
				399-3	390-3	-
Cape Chisel		7"	1/4"	3226	3232	-
Diamond Point Chisel		7"	1/4"	3224	3230	-
Round Hose Chisel		7"	1/4"	3225	3231	-
Non-Sparking Chisel		8"	2"	380-BC	-	-

Please specify part number when ordering. Longer lengths and other blade styles also available.

## Complete Needle Scaler Attachment and Replacement Parts



Needle Tube

**Model 1392** Needle Attachment  
Fits MP-1SR Series & Cleco

### Replacement Parts for Model 1392

MPT Part No.	Cleco Part No.	Description
1370	834779	Needle Tube
1371	834044	Spring
3mm19	834024	Needle Set
375	834046	Needle Holder
373	834045	Driver



Spring Seat  
(1393 & IR style only)

**Model 1393** Needle Attachment  
Fits MP-182 Series & Ingersoll-Rand

### Replacement Parts for Model 1393

MPT Part No.	IR Part No.	Description
1380	NS11-A24	Needle Tube
NS11-A25	NS11-A25	Spring Seat
1381	NS11-27	Spring
3mm19	NS11-122	Needle Set
NS11-21	NS11-21	Needle Holder
371	NS11-20	Driver

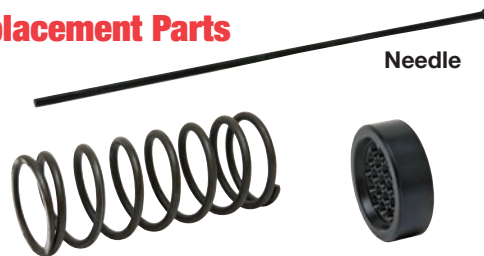

Needle

Spring



Needle Holder

**Model 1394** Needle Attachment  
Fits MP-455C Series & CP-455

### Replacement Parts for Model 1394

MPT Part No.	CP Part No.	Description
1350	P100151	Needle Tube
1371	P100150	Spring
3mm19	P100146	Needle Set
375	P100145	Needle Holder
374	P100144	Driver



Driver

# Needle Scalers & Replacement Needles



Part No. (size x qty./set)	Part No. (size x qty./set)	Part No. (size x qty./set)
2mm29	-	-
2mm32	-	-
2mm51	-	-
2mm65	-	-
2mm111	-	-
3mm12	3mm12P	3mm12C
3mm15	3mm15P	3mm15C
3mm19	3mm19P	3mm19C
3mm28	3mm28P	3mm28C
3mm49	3mm49P	3mm49C
4mm7	4mm7P	4mm7C
4mm10	4mm10P	4mm10C
4mm19	4mm19P	4mm19C
4mm35	4mm35P	4mm35C

## Replacement Needle Sets

Three types of needles including pointed tip, chisel tip, and flat tip are available. Designed for scaling, removing welding slag, and barnacles. Ideal for heavy paint removal. Needles conform to any surface contour.

- 3MM19-STAINLESS** 3mm Stainless Steel Needle Set (19 pc.)  
**3MM19-BC** 3mm Beryllium Copper Needle Set (19 pc.)

Flat



Point



Chisel



## Michigan Pneumatic Model MP-25NS

### Needle Scaler

Very powerful for its size. Ideal for use as a chisel gun for cutting metal, or a needle gun for cleaning contoured surfaces. Removes rust or paint and de-slugs metal surfaces. Lever throttle offers easy, accurate control of chiseling action. Used for scaling in assembly shops, steel mills and foundries. Can also be used to remove caulking. **Model MP-25 Scaling Hammer available.**

**2527NS-ASM** Needle Attachment

Takes style 100 - 1/2" quarter octagon chisel.

Bore.....	1"	Length.....	16-3/8"
Stroke.....	7/8"	Weight.....	5.75 lbs.
Blows Per Minute .....	4000	Air Inlet Thread .....	1/4"
Rec'd Hose Size .....	1/4"	Avg. Air Consumption .....	4 cfm



## Nitto Kohki Model JT-20

### Needle Scaler

This lightweight, ergonomic needle scaler is used for de-slugging welds, cleaning brick, stonework, boats and many other surfaces. Ideal for heavy paint removal. The needles conform to any surface contour.

#### Replacement Parts

- 00A342-29** 2mm Needle Set (29 pc.)      **00A338** 2mm Supporter  
**00A341-12** 3mm Needle Set (12 pc.)      **00A337** 3mm Supporter  
**00A332** Piston      **00A336** Anvil

Bore.....	25/32"	Length.....	13-37/64"
Stroke.....	21/32"	Weight.....	5.3 lbs.
Blows Per Minute .....	4000	Air Inlet Thread .....	3/8"
Rec'd Hose Size .....	3/8"	Avg. Air Consumption .....	7.8 cfm



## Nitto Kohki Model JEX-20

### Needle Scaler

This ergonomic needle scaler is used for cleaning brick and stonework, de-slugging welds, cleaning boat hulls and many other surfaces. Ideal for heavy paint removal.

#### Replacement Parts

- 00A342-29** 2mm Needle Set (29 pc.)      **00A338** 2mm Supporter  
**00A341-12** 3mm Needle Set (12 pc.)      **00A337** 3mm Supporter  
**00A332** Piston      **00A336** Anvil

Bore.....	51/64"	Length.....	13-11/16"
Stroke.....	1.1"	Weight.....	6.1 lbs.
Blows Per Minute .....	4000	Air Inlet Thread .....	3/8"
Rec'd Hose Size .....	3/8"	Avg. Air Consumption .....	7.8 cfm



# Needle Scalers



## Nitto Kohki Model JC-16

### Needle Scaler

Used for removing rust, cleaning metals, peening welded joints and cleaning hardened concrete from construction equipment. Tool includes two sets of 2mm flat needles.

#### Replacement Parts

<b>00A291-29</b>	2mm Needle Set (29 pc.)	<b>00A290</b>	2mm Supporter
<b>00A288</b>	Piston	<b>00A289</b>	Anvil

Piston Diameter.....	5/8"	Length.....	11"
Stroke.....	0.86"	Weight.....	3.1 lbs.
Blows Per Minute.....	4000	Air Inlet Thread.....	3/8"
Rec'd Hose Size.....	3/8"	Avg. Air Consumption.....	3.5 cfm



## Nitto Kohki Model JEX-24

### Needle Scaler

Versatile design for working in any confined space. Ideal for de-slagging, removing rust, paint or scale from irregular or curved surfaces. Tool includes one set of 3mm flat needles.

#### Replacement Parts

<b>00A342-53</b>	2mm Needle Set (53 pc.)	<b>02A244</b>	2mm Supporter
<b>00A341-23</b>	3mm Needle Set (23 pc.)	<b>02A245</b>	3mm Supporter
<b>02A242</b>	Piston	<b>02A243</b>	Anvil

Piston Diameter.....	15/16"	Length.....	13-3/4"
Stroke.....	1.1"	Weight.....	6 lbs.
Blows Per Minute.....	4000	Air Inlet Thread.....	3/8"
Rec'd Hose Size.....	3/8"	Avg. Air Consumption.....	7.8 cfm



## Nitto Kohki Model JEX-28

### Needle Scaler

Cleans and descales jobs quickly. Gets deep into corners, uneven surfaces and curves. Tool includes 2 sets of 3mm flat needles and 2 sets of 4mm point needles with needle supporters for each size.

#### Replacement Parts

<b>00A342-66</b>	2mm Needle Set (66 pc.)	<b>01A499</b>	2mm Supporter
<b>00A341-28</b>	3mm Needle Set (28 pc.)	<b>01A461</b>	3mm Supporter
<b>00A402-14</b>	4mm Needle Set (14 pc.)	<b>01A462</b>	4mm Supporter
<b>00A395</b>	Piston	<b>00A399</b>	Anvil

Piston Diameter.....	1-3/32"	Length.....	14-3/4"
Stroke.....	1.18"	Weight.....	7.7 lbs.
Blows Per Minute.....	4500	Air Inlet Thread.....	3/8"
Rec'd Hose Size.....	3/8"	Avg. Air Consumption.....	8.8 cfm



## Nitto Kohki Model EJC-32A

### Electric Needle Scaler

Applications include removing weld spatters and surface processing on concrete and rocks. Also excellent for descaling paint or rust, removing sand from cast parts, and removing barnacles from ocean vessels. Features a slim barrel design, double insulated, and a free subhandle that positions to best fit the working situation. **Also available in 220 volt AC, Model EJC-32A-220.**

#### Replacement Parts

<b>00A342-32</b>	2mm Needle Set (32 pc.)	<b>TP16475</b>	2mm Supporter
<b>00A341-15</b>	3mm Needle Set (15 pc.)	<b>TP16301</b>	3mm Supporter
<b>TP16339</b>	Piston	<b>TP16302</b>	Anvil

Power Supply.....	AC 115V 60Hz	Current.....	2.8A
Power Consumption.....	300W	Length.....	20-1/2"
Stroke Speed.....	3000/min.	Weight.....	9.9 lbs.

# Piston Scalers



**NPK®**

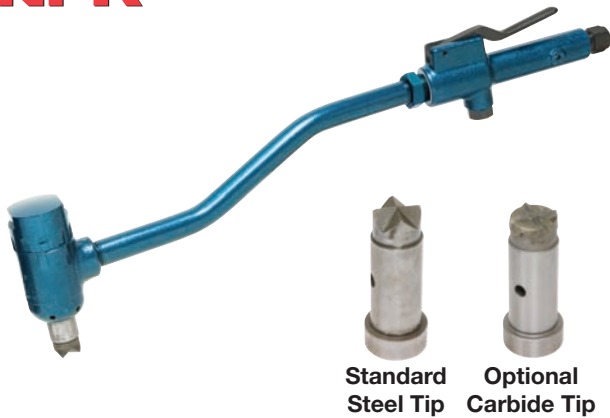

## Nippon Pneumatic Model S-2L

### Scaling Hammer

Strong and lightweight with a single reciprocating piston and grip ring throttle. Delivers rapid vibrating action to remove old paint, rust and scale from structural steel, boilers, tanks and castings. No chisels are required as the hammer piston itself acts as a chisel.

**H-30203** Steel Tip Piston (each)  
**F22B00C550** Carbide Tip Piston (each)

Piston Diameter.....	1-3/16"	Height.....	4"
Stroke.....	9/16"	Weight.....	5.9 lbs.
Length.....	19-1/2"	Air Inlet Thread.....	3/8"
Blows Per Minute.....	3500	Avg. Air Consumption.....	14.1 cfm

Standard Steel Tip      Optional Carbide Tip

**NPK®**

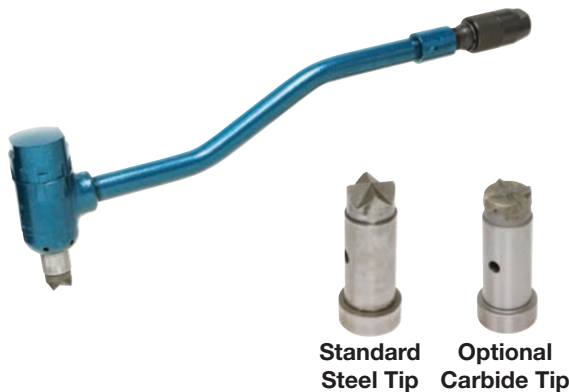

## Nippon Pneumatic Model S-2

### Scaling Hammer

Single reciprocating piston delivers rapid blows to remove rust, scale, and old paint. Designed for structural steel and boiler industries.

**H-30203** Steel Tip Piston (each)  
**F22B00C550** Carbide Tip Piston (each)

Piston Diameter.....	1-3/16"	Height.....	4"
Stroke.....	9/16"	Weight.....	4.6 lbs.
Length.....	19-5/16"	Air Inlet Thread.....	3/8"
Blows Per Minute.....	3500	Avg. Air Consumption.....	14.1 cfm

Standard Steel Tip      Optional Carbide Tip



MADE U.S.A. IN THE



## Michigan Pneumatic Model S1

### Scaling Hammer

Designed for removing paint, rust and cement from steel. Compact design used in areas where the T3 will not fit.

**TX-00146** Steel Tip Piston (each)  
**TX-00147** Steel Tip Piston, 2" longer than standard (each)  
**TX-00150** Carbide Tipped Piston (each)  
**TX-00151** Rexalloy, Solid Cobalt Alloy Piston (each)

Piston Diameter.....	1"	Height.....	5-7/8"
Stroke.....	13/16"	Weight.....	4.5 lbs.
Length.....	9"	Air Inlet Thread.....	3/8"
Blows Per Minute.....	4000	Avg. Air Consumption.....	9 cfm

TX-00146



MADE U.S.A. IN THE



## Michigan Pneumatic Model T3

### Lever Type Triplex Scaler

Triple piston scaler designed for roughing cement and removing rust and paint. Features rugged steel body and lever throttle.

**TX-00146** Steel Tip Piston (each)  
**TX-00147** Steel Tip Piston, 2" longer than standard (each)  
**TX-00150** Carbide Tipped Piston (each)  
**TX-00151** Rexalloy, Solid Cobalt Alloy Piston (each)

Piston Diameter.....	1"	Height.....	5-7/8"
Stroke.....	13/16"	Weight.....	8.25 lbs.
Length.....	11"	Air Inlet Thread.....	3/8"
Blows Per Minute.....	5200	Avg. Air Consumption.....	15 cfm

TX-00146

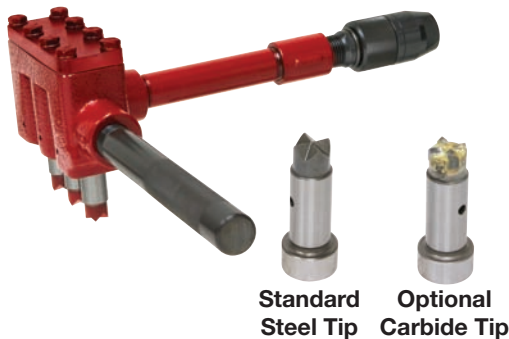

## Michigan Pneumatic Model MP-40030

### Triplex Scaler

Heavy-duty triple piston scaler designed to scale bridges, ship hulls and railroad cars. Can be mounted to a frame for multiple tool work. A dead handle is standard, and may be replaced with a pipe plug for scaling in close quarters.

**H-31203** Steel Tip Piston (each)  
**F24B00C550** Carbide Tip Piston (each)

Piston Diameter.....	7/8"	Height.....	3-3/8"
Stroke.....	3/8"	Weight.....	7 lbs.
Length.....	13"	Air Inlet Thread.....	3/8"
Blows Per Minute.....	7000	Avg. Air Consumption.....	19.4 cfm

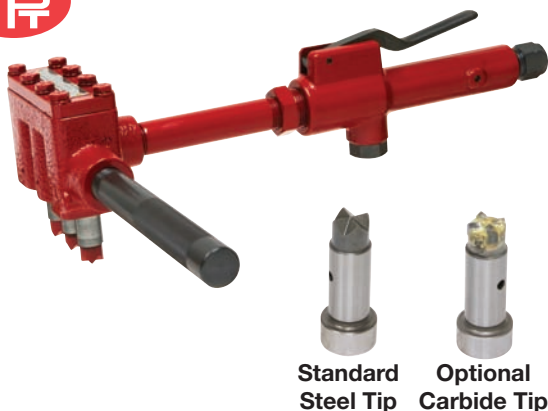

## Michigan Pneumatic Model MP-40030L

### Lever Type Triplex Scaler

Designed for heavy-duty work such as scaling bridges, ship decks and hulls, railroad cars, structural steel pipe, and roughing concrete. Can be mounted to a frame for multiple tool work. A dead handle is standard, and may be replaced with a pipe plug for scaling in close quarters.

**H-31203** Steel Tip Piston (each)  
**F24B00C550** Carbide Tip Piston (each)

Piston Diameter.....	7/8"	Height.....	3-3/8"
Stroke.....	3/8"	Weight.....	8.4 lbs.
Length.....	13-1/16"	Air Inlet Thread.....	3/8"
Blows Per Minute.....	7000	Avg. Air Consumption.....	19.4 cfm



**H-34203**  
Carbide Tip Piston (each)



## Michigan Pneumatic Model MP-NCS-9

### Lorry Type Concrete Scaler

**Features nine built-in reciprocating pistons.** Carbide tipped pistons effectively remove laitance covering the surface of primary concrete. Simultaneously forms a desirable surface coarseness to facilitate spreading and adhering of the final layers. New device rolls easily on two wheels to cut time and cost. Scales concrete at a rate of 23 to 28 square yards per hour.

Piston Diameter.....	1-1/2"	Height.....	17"
Number of Pistons.....	9	Weight.....	198 lbs.
Rec'd Hose Size.....	3/4"	Air Inlet Thread.....	3/4"
Blows Per Minute.....	4000	Avg. Air Consumption.....	30 cfm

# Bench Type Sand Rammers



MADE  
U.S.A.  
IN THE

## Michigan Pneumatic Model MP-00G-NN

### Sand Rammer

Lightweight, streamlined design for better control and reduced operator fatigue. Hard, rapid hitting performance ideal for refractory sand work. **Additional rubber butts available in 1-3/4" or 2-1/2" diameter.**

Bore.....	11/16"	Length.....	11-3/4"
Stroke.....	2"	Weight.....	3.75 lbs.
Taper.....	S	Air Inlet Thread.....	3/8"
Blows Per Minute.....	1600	Butt Diameter.....	1-3/4" Rubber



MADE  
U.S.A.  
IN THE

## Michigan Pneumatic Model MP-0B

### Sand Rammer

Lightweight, rugged construction delivers fast hitting performance. Lower operator fatigue. **Additional rubber butts available in 1-3/4" to 3-1/4" diameter.**

Bore.....	1"	Length.....	16-1/2"
Stroke.....	2"	Weight.....	6.65 lbs.
Taper.....	802	Air Inlet Thread.....	1/4"
Blows Per Minute.....	2500	Butt Diameter.....	2-1/2" Rubber



F40010D700  
1-5/8" Rubber Butt

## Nippon Pneumatic Model B-00A

### Sand Rammer

Improved sand rammer delivers fast, powerful blows with minimal shock. New throttle lever design provides greater ease of handling for ramming small and medium flasks on jobs molded on the bench. Ideal for the core room. Also used for light backfill tamping. **Additional rubber butts available in 1-3/4" to 3-1/4" diameter.**

Bore.....	3/4"	Length.....	14"
Stroke.....	2-3/8"	Weight.....	4.5 lbs.
Taper.....	S	Air Inlet Thread.....	3/8"
Blows Per Minute.....	1600	Butt Diameter.....	1-5/8" Rubber



F41010D700  
2" Rubber Butt

## Nippon Pneumatic Model B-0A

### Sand Rammer

Improved sand rammer delivers fast, powerful blows for ramming small, medium and large flasks on the bench or floor. New throttle lever design provides greater ease of handling with reduced operator fatigue. **Additional rubber butts available in 2-1/2" to 4" diameters.**

Bore.....	7/8"	Length.....	13-9/16"
Stroke.....	2-3/4"	Weight.....	7 lbs.
Taper.....	M	Air Inlet Thread.....	3/8"
Blows Per Minute.....	750	Butt Diameter.....	2" Rubber



F42010D700  
2-1/2" Rubber Butt

## Nippon Pneumatic Model B-1A

### Sand Rammer

Fast, hard hitting design to deliver maximum power for smooth, efficient work. Lightweight, improved construction provides ease of operation and control. Great for heavy tamping, ramming fire clay and ideal for furnace work. **Additional rubber butts available in 2-1/2" to 4" diameters.**

Bore.....	1"	Length.....	19-1/8"
Stroke.....	4-1/2"	Weight.....	12.5 lbs.
Taper.....	ML	Air Inlet Thread.....	3/8"
Blows Per Minute.....	850	Butt Diameter.....	2-1/2" Rubber

# Bench Type Sand Rammers



MADE  
U.S.A.  
IN THE

## Michigan Pneumatic Model MP-BD2BA

### Sand Rammer

Most popular bench rammer manufactured. Power-to-weight ratio exceeds all others in its class. Identical to the original Master Power and Black & Decker tools. **Additional rubber butts available in 2-1/2" or 3-1/4" diameter.**

Bore.....	1"	Length.....	15-1/4"
Stroke.....	2-1/2"	Weight.....	7.125 lbs.
Taper.....	802	Air Inlet Thread.....	3/8"
Blows Per Minute.....	1725	Butt Diameter.....	2-1/2" Rubber



MADE  
U.S.A.  
IN THE

Flat rod piston available

## Michigan Pneumatic Model MP-BD1BA

### Sand Rammer

Ideal for use where more compacting force and reliability are a must. Manufactured using the highest quality steel and materials to ensure long life with minimal repairs. **Additional rubber butts available in 2-1/2" or 3-1/4" diameter. Model MP-BD1BAFR with flat rod piston available.**

Bore.....	1"	Length.....	20-1/4"
Stroke.....	4"	Weight.....	10 lbs.
Taper.....	802	Air Inlet Thread.....	3/8"
Blows Per Minute.....	1240	Butt Diameter.....	2-1/2" Rubber



MADE  
U.S.A.  
IN THE

Flat rod piston available

## Michigan Pneumatic Model MP-130

### Sand Rammer

Lightweight for compacting sand molds in foundries. Unique double-action seal protects the tool from dirt and other contaminants for longer tool life. **Model MP-130FR with flat rod piston available. Additional rubber butts available in 1-3/4" or 3-1/4".**

Bore.....	1"	Length.....	16-1/2"
Stroke.....	2-1/2"	Weight.....	8.5 lbs.
Taper.....	801	Air Inlet Thread.....	1/4"
Blows Per Minute.....	870	Butt Diameter.....	2-1/2" Rubber



MADE  
U.S.A.  
IN THE

## Michigan Pneumatic Model MP-140

### Sand Rammer

Unique double-action seal protects the tool from dirt and other contaminants for longer tool life. **Model MP-150 floor type tamper also available. Additional rubber butts available in 2-1/2" or 4".**

Bore.....	1-1/8"	Length.....	20"
Stroke.....	4"	Weight.....	11.25 lbs.
Taper.....	801	Air Inlet Thread.....	1/4"
Blows Per Minute.....	730	Butt Diameter.....	3-1/4" Rubber



8-1/8"

## Michigan Pneumatic Model MP-B401MR

### Corner Rammer

Strong and lightweight with a single reciprocating piston and grip ring throttle. Delivers a rapid compacting action which effectively rams refractory material and sand in hard to reach areas.

**202-802SP** 2-1/2" Rubber Butt

Bore.....	1"	Length.....	19-1/4"
Stroke.....	9/16"	Weight.....	4.6 lbs.
Taper.....	802	Air Inlet Thread.....	3/8"
Blows Per Minute.....	8000	Butt Diameter.....	2-1/2" Rubber

# Floor Type Tampers



Michigan Pneumatic Model MP-BD2BA-LR

## Sand Rammer/Tamper

Popular rammer with power-to-weight ratio exceeding all others in its class. Identical to the original Master Power and Black & Decker tools. **Additional rubber butts available in 3-1/4" or 4" diameter.**

MADE  
**U.S.A.**  
IN THE



Bore..... 1"	Length ..... 42-5/16"
Stroke..... 2-1/2"	Weight ..... 16.25 lbs.
Taper ..... 802	Air Inlet Thread ..... 1/2"
Blows Per Minute ..... 1725	Butt Diameter 2-1/2" Rubber

Michigan Pneumatic Model MP-BD1BA-LR

## Sand Rammer/Tamper

Ideal for use where more compacting force and reliability are a must. Manufactured using the highest quality steel and materials to ensure long life with minimal repairs. **Additional rubber butts available in 3-1/4" or 4" diameter. Model MP-BD1BAFR-LR with flat rod piston available.**

MADE  
**U.S.A.**  
IN THE



Flat rod piston available

Bore..... 1"	Length ..... 41-3/8"
Stroke..... 4"	Weight ..... 18.1 lbs.
Taper ..... 802	Air Inlet Thread ..... 1/2"
Blows Per Minute ..... 1240	Butt Diameter 2-1/2" Rubber

Michigan Pneumatic Model MP-241A1M

## Sand Rammer/Tamper

Easy to hold from a standing position. Perfect for compacting large molds. **MP-241A1MFR with flat rod piston available.**

MADE  
**U.S.A.**  
IN THE



Flat rod piston available

Bore..... 15/16"	Length ..... 52-1/2"
Stroke..... 4"	Weight ..... 26.0 lbs.
Taper ..... 803	Air Inlet Thread ..... 1/2"
Blows Per Minute ..... 1590	Butt Diameter 3-1/4" Rubber

Michigan Pneumatic Model MP-341A1M

## Sand Rammer/Tamper

Favorite among municipal utility crews. Proven tool for backfilling around foundations. **Optional 3-1/2" steel butts available. Model MP-441 also available.**

MADE  
**U.S.A.**  
IN THE



Bore..... 1-5/8"	Length ..... 52-3/4"
Stroke..... 4"	Weight ..... 35.0 lbs.
Taper ..... T	Air Inlet Thread ..... 1/2"
Blows Per Minute ..... 1550	Butt Diameter ..... 6" Steel





# Floor Type Tampers

Nippon Pneumatic **Model F-1**

## Sand Rammer/Tamper

Developed to bridge the gap between bench rammers and floor rammers. Ideal for compacting sand in molds that cannot be accessed with a bench style rammer. **Additional rubber butts available in 2-1/2" to 5" diameters.**



Bore.....	1"	Length.....	43-3/16"
Stroke.....	4-5/16"	Weight.....	15.00 lbs.
Taper.....	ML	Air Inlet Thread.....	1/2"
Blows Per Minute.....	850	Butt Diameter	2-1/2" Rubber

Nippon Pneumatic **Model F-2**

## Sand Rammer/Tamper

Designed with a new automatic valve which eliminates unnecessary maintenance normally encountered with sand and dirt abrasion. Piston is plated for long life. Ideal for backfill tamping between foundations and other job site obstructions. **Additional rubber butts available in 2-1/2" to 5" diameters.**



Bore.....	1-1/4"	Length.....	44"
Stroke.....	4-23/32"	Weight.....	20.75 lbs.
Taper.....	L	Air Inlet Thread.....	1/2"
Blows Per Minute.....	700	Butt Diameter	2-3/4" Rubber

Nippon Pneumatic **Model F-4**

## Sand Rammer/Tamper

Delivers rapid, powerful blows for heavy-duty tamping. Designed to compact soil around foundations and backfill in trenches. Chrome plated piston rod resists wear caused by dirt and sand abrasion. Piston rod packing and adjustments can be performed on the job without the need of special tools. **Additional rubber butts available in 3-1/4" to 5" diameters.**



Bore.....	1-9/16"	Length.....	44"
Stroke.....	4-23/32"	Weight.....	26.50 lbs.
Taper.....	T	Air Inlet Thread.....	1/2"
Blows Per Minute.....	800	Butt Diameter.....	6" Steel

Michigan Pneumatic **Model MP-6T**

## Sand Rammer/Tamper

Designed for operator comfort, maximum work output and minimum maintenance. Delivers rapid, powerful blows for compacting soil around foundations and backfilling trenches. **Pole butt and 3-1/2" steel butt available.**

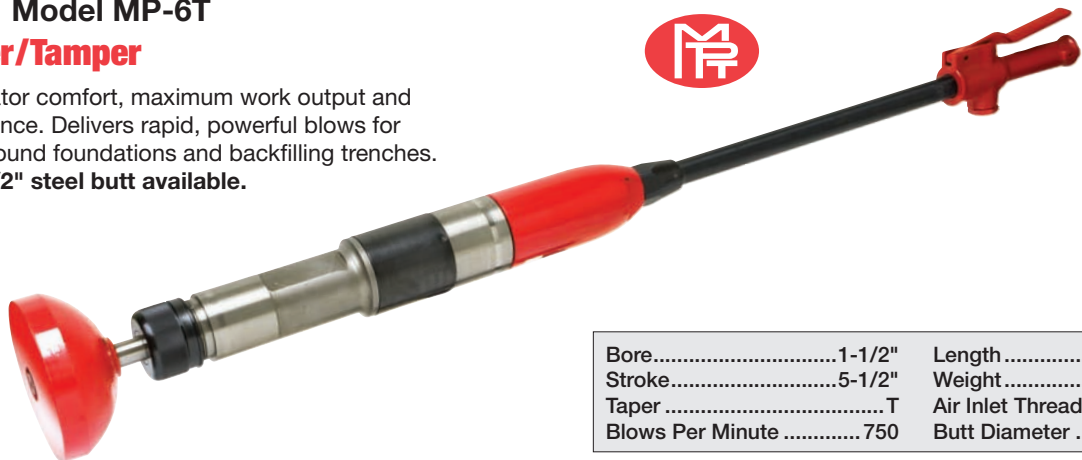

Bore.....	1-1/2"	Length.....	49"
Stroke.....	5-1/2"	Weight.....	39.50 lbs.
Taper.....	T	Air Inlet Thread.....	1/2"
Blows Per Minute.....	750	Butt Diameter.....	6" Steel

# Bench Rammer Accessories



## Rubber Rammer Butts

Made of the finest neoprene to ensure uniformity of bonding. Highly resistant to oil and wear. **Please specify tool model number and size of butt when ordering.** Solid aluminum, steel and rectangular butts available.



Tool Model No.	Butt Model No.	Size
MP-00G-NN MP-20BA B-00A	F40010D700 201-S 202-S 203-S	1-1/2" 1-3/4" 2-1/2" 3-1/4"
MP-130 MP-140	201-801 202-801 203-801	1-3/4" 2-1/2" 3-1/4"
MP-150	202-801 203-801 204-801 205-801	2-1/2" 3-1/4" 4" 5"
MP-0B MP-BD2BA MP-BD2BA-LR MP-BD1BA MP-BD1BA-LR	202-802 203-802	2-1/2" 3-1/4"
MP-241A1M	203-803 204-803 205-803	3-1/4" 4" 5"

Tool Model No.	Butt Model No.	Size
MP-10BA B-0A F-0	201-M 202-M 203-M 204-M	1-3/4" 2-1/2" 3-1/4" 4"
MP-14 B-1A F-1 MP-114	202-ML 203-ML 204-ML	2-1/2" 3-1/4" 4"
MP-1F F-2	202-L 203-L 204-L 205-L	2-1/2" 3-1/4" 4" 5"
MP-F4 MP-6T F-4 MP-341A1M	203-T F54000D700 204-T 205-T	3-1/4" 3-7/16" 4" 5"

## Steel Rammer Butts



Tool Model No.	Butt Model No.	Size	Bolt Part No.
MP-00G, MP-20BA & B-00A MP-10BA, B-0A & F-0 MP-14, B-1A & F-1	RG-01420 RG-03420 RG-04420	2-1/2"	-
MP-1F & F-2	RG-06420 F53A00D210	2-3/4"	-
MP-BD2BA, MP-BD2BA-LR, MP-BD1BA & MP-BD1BA-LR	TX-00202	2-1/2" w/bolt hole	TX-00203
MP-6T & MP-341A1M	73206 34SR-ST183 5.250-M-78	6" w/bolt hole 3-3/8" 5-1/4" U-Shape	34SR-85
MP-F4 & F-4	RG-07420 RG-07420-SP F54A00D210	6" 6" w/bolt hole 3-11/32"	- 34SR-85 -

## 6" Steel Butts

Fits: Thor 6T & 66T, IR 34 & 341, Jet 06 & APT-131 Backfill Tampers

**Model 73206**  
6" Steel Butt



34SR-85 Bolt

Fits: MP-F4, MP-B66 and most backfill tampers (does not accommodate butt locking screw)

**Model RG-07420**  
6" Steel Butt



## Throttle Handles

Fits: MP-1F, MP-F4 & MP-114

**Model 033**  
Throttle/Live Handle



Fits: MP-1F, MP-F4 & MP-114

**Model 24SR-A160**  
Throttle/Live Handle



Fits: IR-341, IR-441, APT-131, Thor & CP

**Model 241SR-A160-E**  
Large Volume Throttle/Live Handle



Fits: IR-341, IR-441, APT-131, Thor & CP

**Model 241SR-A160-STEEL**  
Large Volume Throttle/Live Handle



# Clay Diggers & Demolition Tools



Michigan Pneumatic

## 20 lb. & 30 lb. Class Clay Digger

Versatile, powerful tools designed for digging clay, cutting hard pan or loosening compacted or frozen ground. Ideal for trench digging and demolition work, excavating, cutting brick or asphalt and breaking light concrete. Latch-type retainer models allow operator to change chisels easily. Available in a variety of shanks and sizes. Please specify. Optional T-handle 0448052 available. Parts for MP-733 models are interchangeable with Ingersoll-Rand Model 73 and 93 diggers. Parts for MP-955 models are interchangeable with Ingersoll-Rand Model 75 and 95 diggers.

Model MP-733-LAT95-78  
Clay Digger



Model MP-955T-LAT95  
T-Handle Clay Digger



Model MP-955-LAT95-78  
Clay Digger

273H-22

Hitch Cutter Retainer



Model MP-733-34  
Clay Digger

Model No.	Shank Type	Piston Stroke	Piston Diameter	Blows Per Minute	Retainer Type	Length	Weight	Air Inlet Thread	Avg. Air Consumption
MP-733-34	3/4" Square x 2-3/4"	2-1/2"	1-11/16"	1500	Sleeve	19-1/4"	21.90 lbs.	3/8"	39 cfm
MP-733-78	7/8" Hex x 3-1/4"				Sleeve	19-1/4"	21.90 lbs.		
MP-733-LAT95-34	3/4" Square x 2-3/4"				Latch	18-7/8"	26.30 lbs.		
MP-733-LAT95-78	7/8" Hex x 3-1/4"				Latch	18-7/8"	26.30 lbs.		
MP-955-34	3/4" Square x 2-3/4"	4-3/8"	1-11/16"	1200	Sleeve	21-3/4"	29.75 lbs.	3/8"	47 cfm
MP-955-78	7/8" Hex x 3-1/4"				Sleeve	21-3/4"	29.75 lbs.		
MP-955-LAT95-34	3/4" Square x 2-3/4"				Latch	21-3/4"	35.25 lbs.		
MP-955-LAT95-78	7/8" Hex x 3-1/4"				Latch	21-3/4"	35.25 lbs.		
MP-955T-LAT95-34	3/4" Square x 2-3/4"	4-3/8"	1-11/16"	1200	Latch	30-3/4"	39.20 lbs.	3/8"	47 cfm
MP-955T-LAT95-78	7/8" Hex x 3-1/4"				Latch	30-3/4"	39.20 lbs.		



Michigan Pneumatic **Model MP-TCD18-78 - 7/8" Hex**  
**Model MP-TCD18-1 - 1" Hex**

## 30 lb. Class Clay Digger

Heavy-duty machine for all construction applications, including digging clay, gravel, hard pan and frozen ground. Ideal for excavating in tunnels and other restricted quarters. Exceptional power for light demolition, wall breaking and stake driving. Available in 7/8" hex x 3-1/4" or 1" hex x 4-1/4". Please specify. Parts are interchangeable with Thor Model 18 digger.



Piston Stroke	3-3/8"	Length	22"
Piston Diameter	1-3/4"	Weight	30 lbs.
Blows Per Minute	1550	Air Inlet Thread	3/4"
Rec'd Hose Size	1/2"	Retainer Type	Latch

# Pavement Breakers



**MP-17**  
30 lb. Class



**MP-23118**  
60 lb. Class



**MP-91118**  
90 lb. Class



## CP Style Pavement Breakers

Model No.	Shank Size	Piston Stroke	Piston Diameter	Blows Per Minute	Length	Weight	Rec'd Hose Size	Air Inlet Thread	Avg. Air Consumption
MP-17	1" Hex x 4-1/4"	5"	1-7/8"	1450	21"	40 lbs.		1/2"	48 cfm
MP-23118	1-1/8" Hex x 6"	5-1/2"	2-3/8"	1350	26"	64 lbs.	3/4"	3/4"	64 cfm
MP-23114	1-1/4" Hex x 6"	5-1/2"	2-3/8"	1350	26"	64 lbs.		3/4"	64 cfm
MP-91118	1-1/8" Hex x 6"	6-1/4"	2-5/8"	1250	28"	92 lbs.		3/4"	85 cfm
MP-91114	1-1/4" Hex x 6"	6-1/4"	2-5/8"	1250	28"	92 lbs.		3/4"	85 cfm

Hard hitting, heavy weight breaker features smooth operation for general use breaking asphalt, concrete and brick. Features extra-sturdy four bolt head-to-cylinder construction, full control throttle, efficient valve chest for low maintenance operation, drop-forged cylinder, replaceable front end bushing, chisel retainer latch and rubber hand grips.

## Model Interchange

Chicago Pneumatic	Michigan Pneumatic
1210	MP-17
1230	MP-23118 / MP-23114
1240	MP-91118 / MP-91114



**CB-153**  
40 lb. Class

## Nippon Pneumatic Models CB-152 & CB-153

### 40 lb. Class Pavement Breakers

Lightweight, compact, hard hitting tools excellent for light and medium demolition work. Reduced recoil and shortened length make these breakers easy to operate. Ideal for bridge deck work. **Available in 7/8" hex x 3-1/4" or 1" hex x 4-1/4" shank size. Please specify.**

Model	CB-152	CB-153
Shank Size	7/8" Hex x 3-1/4"	1" Hex x 4-1/4"
Piston Stroke	1-3/8"	1-3/8"
Piston Diameter	1-1/2"	1-1/2"
Blows Per Minute	1300	1300
Length	21-1/8"	21-13/16"
Weight	38 lbs.	38 lbs.
Rec'd Hose Size	3/4"	3/4"
Air Inlet Thread	3/4"	3/4"
Avg. Air Consumption	50 cfm	50 cfm



**MP-30**  
30 lb. Class



**MP-TPB60**  
60 lb. Class



**MP-TPB90**  
90 lb. Class



## Thor Style Pavement Breakers

Model No.	Shank Size	Piston Stroke	Piston Diameter	Blows Per Minute	Length	Weight	Rec'd Hose Size	Air Inlet Thread	Avg. Air Consumption
MP-30-78	7/8" Hex x 3-1/4"	3-3/8"	1-3/4"	1550	22-1/2"	33 lbs.	1/2"	3/8"	39 cfm
MP-30-1	1" Hex x 4-1/4"	3-3/8"	1-3/4"	1550	22-1/2"	33 lbs.	1/2"	3/8"	39 cfm
MP-TPB60-118	1-1/8" Hex x 6"	5"	2-1/4"	1400	25-3/8"	66 lbs.	3/4"	3/4"	58 cfm
MP-TPB60-114	1-1/4" Hex x 6"	5"	2-1/4"	1400	25-3/8"	66 lbs.	3/4"	3/4"	58 cfm
MP-TPB90-118	1-1/8" Hex x 6"	6-1/2"	2-5/8"	1200	28-3/4"	91 lbs.	3/4"	3/4"	75 cfm
MP-TPB90-114	1-1/4" Hex x 6"	6-1/2"	2-5/8"	1200	28-3/4"	91 lbs.	3/4"	3/4"	75 cfm

Hard hitting 30 and 60 lb. class tools for light and medium demolition work. Rugged, lightweight design is ideal for plant maintenance, breaking concrete floors or frozen ground and masonry walls. Features rubber hand grips for improved operator comfort and a swivel hose connection. Heavy-duty 90 lb. class designed for ripping out reinforced concrete and tearing out streets. Features durable, rugged pistons for extremely versatile demolition purposes.

## Model Interchange

Thor Power Tool	Michigan Pneumatic
17	MP-30-78/MP-30-1
23	MP-TPB60-118/MP-TPB60-114
125	MP-TPB90-118/MP-TPB90-114



**B37**  
30 lb. Class



**MP-90-118**  
90 lb. Class



## Gardner-Denver Model B37

## Michigan Pneumatic Models MP-90-118 & MP-90-114

## Pavement Breakers

Rugged designs ideal for plant maintenance. Model B37 ideal for bridge deck work. MP-90 series useful for reinforced concrete. **Most of the MP-90 series parts interchangeable with Ingersoll-Rand Model PB8A paving breaker.**

Model	B37	MP-90-118	MP-90-114
Shank Size	1" Hex x 4-1/4"	1-1/8" Hex x 6"	1-1/4" Hex x 6"
Piston Stroke	3-1/2"	6-1/4"	6-1/4"
Piston Diameter	1-7/8"	2-1/2"	2-1/2"
Blows Per Minute	1500	1200	1200
Length	21-1/4"	28"	28"
Weight	38 lbs.	90 lbs.	90 lbs.
Rec'd Hose Size	1/2"	3/4"	3/4"
Air Inlet Thread	3/4"	3/4"	3/4"
Avg. Air Consumption	32 cfm	85 cfm	85 cfm

# Pavement Breaker/Clay Digger Tools & Accessories



## Pavement Breaker Kits

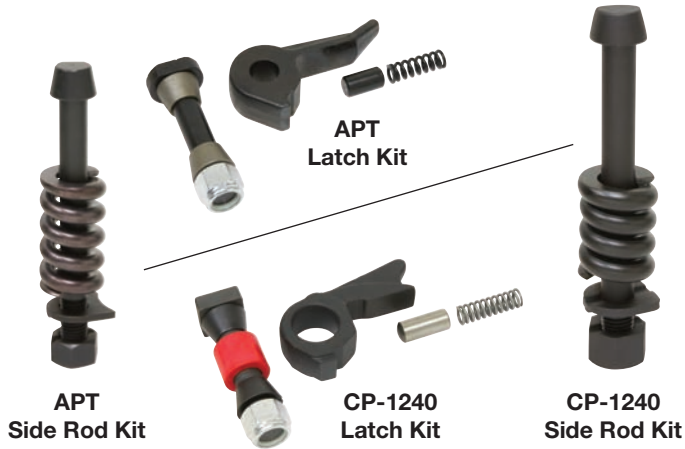

Fits Tool Model No.	Latch Kit No.	Side Rod Kit No.
MP-30 MP-TCD18	LKIT-APT117	-
MP-6	LKIT-IRPB8	SRKIT-IRPB6
MP-90		SRKIT-IRPB8
MP-17	LKIT-CP1210	SRKIT-CP1210
MP-23118 MP-23114	LKIT-CP1230	SRKIT-CP1230
MP-91118 MP-91114	LKIT-CP1240	SRKIT-CP1240
MP-TPB60	LKIT-APT190	SRKIT-APT160
MP-TPB90		SRKIT-APT190
MP-955 (Old) MP-733 (Old)	LKIT-IR159	-
MP-733 (New) MP-955 (New)	LKIT-IR93LA1	-

Additional kits for other manufacturer models available.

## Pavement Breaker Mufflers



Fits Tool Model No.	Part No.
MP-TPB60-118/MP-TPB60-114	6467
MP-TPB90-118/MP-TPB90-114	6052
CP-117	83-AM
MP-17	F814928
MP-23118 / MP-23114	R122152
MP-91118 / MP-91114	F814004



### Narrow Chisel & Moil Point - Standard

Shank Size	Length Under Collar	Chisel No.	Point No.
7/8" x 3-1/4"	14"	923NC	1011
	18"	924	1012
	24"	924-2	1012-2
	36"	924-3	1012-3
1" x 4-1/4"	14"	925	1013
	18"	926	1014
	24"	926-2	1014-2
	36"	926-3	1014-3
1-1/8" x 6"	14"	1030	1019
	18"	1031	1020
	24"	1031-2	1020-2
	36"	1031-3	1020-3
1-1/4" x 6"	14"	1034	1023
	18"	1035	1024
	24"	1035-2	1024-2
	36"	1035-3	1024-3



### Narrow Chisel & Moil Point - Super Duty

Shank Size	Length Under Collar	Chisel No.	Point No.
3/4" sq. x 2-3/4"	14"	1087C	1087P
	18"	1088C	1088P
7/8" hex x 3-1/4"	14"	923R	1011R
	18"	924R	1012R
1" hex x 4-1/4"	14"	925R	1013R
	18"	926R	1014R
1" hex x 6"	14"	1030R	1019R
	18"	1031R	1020R
1" hex x 6"	14"	1034R	1023R
	18"	1035R	1024R



### 3" Chisel

Shank Size	Length Under Collar	Part No.	
		Standard	Super Duty
7/8" x 3-1/4" (2-1/2" blade)	14"	934	934R
	18"	935WC	935R
	24"	935-2	-
	36"	935-3	-
1" x 4-1/4"	14"	936	936R
	18"	937	937R
	24"	937-2	-
	36"	937-3	-
1-1/8" x 6"	14"	1040WC	1040R
	18"	1041WC	1041R
	24"	1041-2	-
1-1/4" x 6"	14"	1042WC	1042R
	18"	1043	1043R
	24"	1043-2	-
	36"	1043-3	-

Longer lengths available.

# Pavement Breaker & Clay Digger Tools



**Bushing Tool - 16 Teeth - 2" x 2" Face**

Shank Size	Length Under Collar	Part No.
3/4" sq. x 2-3/4"	9"	851
7/8" hex x 3-1/4"		846
1" hex x 4-1/4"		847
1" hex x 6"		848
1" hex x 6"		849



**Form Pin Driver - 3/4" Depth x 1-1/4" Diameter**

Shank Size	Length Under Collar	Part No.
7/8" x 3-1/4"	8"	83-3
1" x 4-1/4"		B21991
1-1/8" x 6"		B31991
1-1/4" x 6"		B41991



**Detachable Shank - 1-5/8" Small Diameter For Tamping Pads & Sheathing Driver Shoes**

Shank Size	Length Under Collar	Part No.
7/8" x 3-1/4"	9"	864DS
1" x 4-1/4"		865
1-1/8" x 6"		867DS
1-1/4" x 6"		868



**7" Round Tamping Pad**

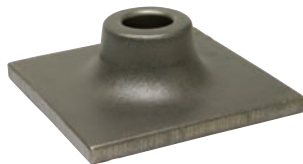

**8" Square Tamping Pad**

**Tamping Pads**

Shank Size	Part No.
6" Square	968
7" Round	965RP
8" Square	969SP



**Sheathing Driver Shoe**

Shank Size	Part No.
2"	1051
3"	1052



**Clay Spade - 5-1/2" Width x 8-1/2" Blade Length**

Shank Size	Length Under Collar	Part No.
3/4" sq. x 2-3/4"	16-1/2"	1078
7/8" hex x 3-1/4"		982
1" hex x 4-1/4"		972
1-1/8" hex x 6"		1075
1-1/4" hex x 6"		1077



**Asphalt Cutter - 5" Width x 6" Blade Length**

Shank Size	Length Under Collar	Part No.
7/8" x 3-1/4"	11"	942
1" x 4-1/4"	12"	943
1-1/8" x 6"	12"	1045
1-1/4" x 6"	12"	1046



**Digging Chisel - 3" Blade Width**

Shank Size	Length Under Collar	Part No.
1" x 4-1/4"	16"	946
1-1/8" x 6"	15-1/2"	1048
1-1/4" x 6"	15-1/2"	1049



**Asphalt Wedge - 3" Width x 6" Blade Length**

Shank Size	Length Under Collar	Part No.
1" x 4-1/4"	12"	836
1-1/8" x 6"		837
1-1/4" x 6"		838



**Frost Wedge - 2" Width x 12" Blade Length**

Shank Size	Length Under Collar	Part No.
1" x 4-1/4"	17"	810
1-1/8" x 6"		812
1-1/4" x 6"		813

Longer lengths available.



## Chicago Pneumatic Model CP-9A

### Roto Hammer



Self-rotating hammer offers versatile service as a masonry drill or demolition tool in drilling hard materials such as bricks and concrete. With non-rotating chisels, the tool can be used for chipping and caulking jobs. Quick change chisel retainer allows fast conversion. Round bushing and clockwise rotation are standard. **NEW IMPORT MODEL MP-9B available. Accessories are listed below and on page 135.**

Blows Per Minute .....	3400	Weight.....	8 lbs.
Piston Diameter .....	1-1/4"	Air Inlet Thread .....	3/8"
Piston Stroke .....	1-3/8"	Avg. Air Consumption .....	20 cfm
Length .....	14-3/4"		

### Solid Carbide Tipped Drills



Part No.	Size	Drill Depth
582CD	5/16"	8"
583	3/8"	
584	7/16"	
585	15/32"	
560	1/2"	8"
561		10"
562	5/8"	8"
563		12"
563-18		18"
564	3/4"	8"
565		12"
565-18		18"
566	7/8"	8"
567		12"
567-18		18"
568	1"	8"
569		12"
569-18		18"
569-24		24"
570	1-1/8"	8"
571		12"
571-18		18"
572	1-1/4"	8"
573		12"
573-18		18"
574	1-3/8"	8"
575		12"
575-18		18"
576	1-1/2"	8"
577		12"
577-18		18"
578	1-5/8"	8"
579		12"
580	1-3/4"	8"
581		12"

### Non-Rotating Drills



Moil Point

Part No.	Length	Weight
4025	10"	2 lbs.



Flat Chisel

Part No.	Length	Weight
4021	10"	2 lbs.

### SDS-Plus Adapter Model R137586

Converts CP-9B to accept SDS-Plus bits.  
See page 135 for SDS-Plus bits



### Rotating Star Drills



Size	Drill Depth		
	4"	8"	12"
	Part No.	Part No.	Part No.
3/8"	4030	4050	-
1/2"	4032	4052	-
5/8"	4034	4054	4070
3/4"	4036	4056	4072
7/8"	4038	4058	4074
1"	4040	4060	4076SD
1-1/8"	4042	4062	4078
1-1/4"	4044	4064	4080SD



# Concrete Vibrators & Roto Hammer Accessories



**NPK®**

Nippon Pneumatic **NRV-70**

## Concrete Vibrator



Powerful, high-frequency vibrators for compaction of concrete to produce dense concrete. Ideal for pours of low slump concrete in walls, columns and close quarters. Rugged, efficient, and easily maneuvered. **All vibrators are equipped with 8 ft. exhaust hose.**



**Roll Throttle**

Vibrating Force .....	658 kg-F	Head Weight .....	25.3 lbs.
Vibrations Per Minute.....	11500	Air Inlet Thread .....	3/8"
Head Diameter.....	3"	Air Consumption.....	45 cfm
Head Length .....	15-3/4"		

Chicago Pneumatic **CP-618**

## Concrete Vibrator

Designed for mass concrete containing up to 6" aggregate deposited from 8-yard buckets, in gravity dams, large piers, massive walls, etc.



Vibrations Per Minute.....	7000
Net Weight .....	65 lbs.
Overall Length .....	50-1/2"
Vibrator Tube Length.....	21"
Vibrator Tube Diameter .....	5-3/4"
Avg. Air Consumption .....	85 cfm

## SDS-Plus Bits



Designed for drilling concrete, brick, stone and other masonry materials. All tips are exclusively "HL Grade" (HL20) carbide. Each shaft is shot-peened for torque twist protection and annealed shafts help prevent breakage.

SDS-Plus bits fit all rotary hammers with SDS-Plus and Hilti chucks. The maximum energy per hammer blow is delivered through positive drive slots. Special asymmetrical spiral, undercut double fluting design removes debris more efficiently to reduce heat and extend drill life. Drills 15% faster than the average drill bit.

### SDS-Plus Shank

Part No.	Size	Drill Depth	Overall Length
90006	3/16"	4"	6"
90007		6"	8"
90004		8"	10"
90008		10"	12"
90010	1/4"	2"	4"
90013		3"	6"
90014		6"	8"
90016		8"	10"
90028		4"	6"
90029	3/8"	6"	8"
90031		8"	10"
90037		4"	6"
90040	7/16"	4"	6"
90041		8"	10"
90043		10"	12"
		4"	6"

### SDS-Plus Shank

Part No.	Size	Drill Depth	Overall Length
90048	9/16"	4"	6"
90052	5/8"	4"	6"
90053		6"	8"
90055		10"	12"
90059	3/4"	6"	8"
90060		8"	10"
90061		10"	12"
90063		16"	18"
90065	5/8"	6"	8"
90067		8"	12"
90069		16"	18"
		6"	8"
90071	1"	8"	10"
90076		16"	18"



## Michigan Pneumatic

### Rock Drills

Powerful, heavy-duty rock drills are recommended for heavy industrial maintenance work. The relative lightweight, fast drilling speed, stamina and easy holding of these drills has made them the standard of comparison the world over. A drill of the right weight and power is available for any kind of job. Ideal for continuous service in quarries and mines and highly effective for general excavation work. Equipped with a latch type retainer.

Model No.	Shank Size	Blows Per Minute	Speed	Piston Dia. x Stroke	Overall Length	Weight
MP-RD30-78314 MP-RD30-78414	7/8" x 3-1/4" 7/8" x 4-1/4"	2450	250 rpm	2-1/8" x 1-3/4"	18-1/2" 19-1/2"	31 lbs.
MP-ERD60-78414 MP-ERD60 MP-RD60-1	7/8" x 4-1/4" 1" x 4-1/4" 1" x 4-1/4"	1800	200 rpm	2-5/8" x 2-9/16"	22-3/8" 22-3/8" 22-3/8"	60 lbs.

Accessories listed below and on page 137.

## Rock Drill Steels



Length Under Collar	7/8" hex x 3-1/4" Steel Shank Size		1" hex x 4-1/4" Steel Shank Size	
	"H" Thread	"E" Thread	"H" Thread	"D" Thread
	Part No.	Part No.	Part No.	Part No.
1 ft.	731-H	731-E	141-H	141-D
1-1/2 ft.	73112-H	73112-E	14112-H	14112-D
2 ft.	732-H	732-E	142-H	142-D
2-1/2 ft.	73212-H	73212-E	14212-H	14212-D
3 ft.	733-H	733-E	143-H	143-D
4 ft.	734-H	734-E	144-H	144-D
5 ft.	735-H	735-E	145-H	145-D
6 ft.	736-H	736-E	146-H	146-D
8 ft.	738-H	738-E	148-H	148-D
10 ft.	7310-H	7310-E	1410-H	1410-D

Please specify part number when ordering. Longer lengths and other shank sizes are available.

## Threaded Rock Bits

MADE  
**U.S.A.**  
IN THE



All Steel



Carbide Insert

Bit Size Diameter	Steel Bit "E" Thread	Steel Bit "H" Thread	Steel Bit "D" Thread	Carbide Bit Single-Use "H" Thread	Carbide Bit Multi-Use* "H" Thread
	Part No.	Part No.	Part No.	Part No.	Part No.
15/16" 1" 1-1/8" 1-1/4"	LE23 LE26 LE28 LE32				
1-3/8" 1-1/2" 1-5/8" 1-3/4" 1-7/8" 2" 2-1/4" 2-1/2" 2-5/8"		LH35SH LH38SH LH41SH LH44SH LH47SH LH50SH LH57SH LH63SH LH66SH	LD452AH LD482AH LD512AH LD572AH LD642AH	HSC138 HSC112 HSC158 HSC134  HSC200	T1207M0 T1507M0 T1607M0 T1707M0 T1907M0 T2007M0 T2207M0 T2507M0
2-3/4" 3" 3-1/4" 3-1/2" 4"			LD702AH LD762AH LD832AH LD892AH LD1012AH		HC234 T3007M0

Please specify part number when ordering. Other series and style bits are available.

\*Multi-use carbide bits are designed for multiple resharpening. See page 137 for additional accessories.

# Drill Steel Accessories & Carbide Tipped Drills



## 7/8" x 3-1/4" Hex Shank

Part No.	Length Under Collar	Size	Drill Depth
546	9"		6"
546-12	12"		9"
546-18	18"	5/8"	15"
546-24	24"		21"
550	9"		6"
550-12	12"		9"
550-18	18"	3/4"	15"
550-24	24"		21"
550-30	30"		27"
551	9"		6"
551-12	12"		9"
551-18	18"	7/8"	15"
551-24	24"		21"
551-30	30"		27"
552	9"		6"
552-12	12"		9"
552-18	18"	1"	15"
552-24	24"		21"
552-30	30"		27"
553-12	12"		9"
553-18	18"	1-1/8"	15"
553-24	24"		21"
553-30	30"		27"
554-12	12"		9"
554-18	18"	1-1/4"	15"
554-24	24"		21"
554-30	30"		27"
555-12	12"		9"
555-18	18"	1-3/8"	15"
555-24	24"		21"
555-30	30"		27"
556-12	12"		9"
556-18	18"	1-1/2"	15"
556-24	24"		21"
556-30	30"		27"

## 7/8" x 4-1/4" Hex Shank

Part No.	Length Under Collar	Size	Drill Depth
546SP	9"		6"
546-12SP	12"		9"
546-18SP	18"	5/8"	15"
546-24SP	24"		21"
547	9"		6"
547-12	12"		9"
547-18	18"	3/4"	15"
547-24	24"		21"
547-30	30"		27"
548CD	9"		6"
548-12	12"		9"
548-18	18"	7/8"	15"
548-24	24"		21"
548-30	30"		27"
549	9"		6"
549-12	12"		9"
549-18	18"	1"	15"
549-24	24"		21"
549-30	30"		27"
553-12SP	12"		9"
553-18SP	18"	1-1/8"	15"
553-24SP	24"		21"
553-30SP	30"		27"
554-12SP	12"		9"
554-18SP	18"	1-1/4"	15"
554-24SP	24"		21"
554-30SP	30"		27"
555-12SP	12"		9"
555-18SP	18"	1-3/8"	15"
555-24SP	24"		21"
555-30SP	30"		27"
556-12SP	12"		9"
556-18SP	18"	1-1/2"	15"
556-24SP	24"		21"
556-30SP	30"		27"

## Drill Steel Extensions

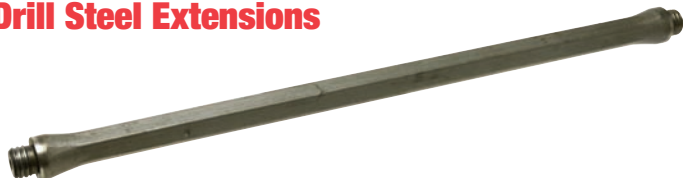

Part No.	Overall Length	Thread
522-2EXT	24"	H
522-3EXT	36"	H
522-4EXT	48"	H
522-5EXT	60"	H
522-6EXT	72"	H
522-8EXT	96"	H

## Adapter & Couplings



**Model TH-D**  
"H" to "D" Adapter

**Model TH-30**  
"H" Threaded Coupling

Other adapters and couplings available.



## 1" x 4-1/4" Hex Shank

Part No.	Length Under Collar	Size	Drill Depth
550-12SPL	12"		9"
550-18SPL	18"		15"
550-24SPL	24"	3/4"	21"
550-30SPL	30"		27"
551-12SPL	12"		9"
551-18SPL	18"	7/8"	15"
551-24SPL	24"		21"
551-30SPL	30"		27"
552-12SPL	12"		9"
552-18SPL	18"	1"	15"
552-24SPL	24"		21"
552-30SPL	30"		27"
553-12SPL	12"		9"
553-18SPL	18"	1-1/8"	15"
553-24SPL	24"		21"
553-30SPL	30"		27"
554-12SPL	12"		9"
554-18SPL	18"	1-1/4"	15"
554-24SPL	24"		21"
554-30SPL	30"		27"
555-12SPL	12"		9"
555-18SPL	18"	1-3/8"	15"
555-24SPL	24"		21"
555-30SPL	30"		27"
556-12SPL	12"		9"
556-18SPL	18"	1-1/2"	15"
556-24SPL	24"		21"
556-30SPL	30"		27"



# NPK®



**RHL-500**  
1/2 Ton Capacity

**RHL-1000**  
1 Ton Capacity

### Efficient, High Speed Material Handling

NPK air hoists are engineered to provide high lifting speeds and accurate control. Lightweight, compact design for use in a stationary position, but can also be quickly moved to another location. Air hoists are extremely useful in hazardous environments where electrical hoists are prohibited. Features external brake adjustment, exhaust muffler, built-in lubricator and swivel mounted air inlet.

### Extra Rugged Construction

Durable construction for constant, heavy-duty use. Designed for fast moving production assembly operations and heavy manufacturing industries.

### Overload-Proof Air Motor for a Wide Safety Margin

The rotary vane air motor is completely enclosed. Motor is unaffected by fumes, dirt or heat. Motor and controls can withstand constant stopping and sudden starting. Can be overloaded or stalled without damage to the hoist. Motor is inherently self-cooling and cannot be burned out.

### Safety Hooks and Automatic Limit Stops

Top and bottom hooks have safety snaps and hoist has automatic limit stops to prevent overtravel.

### Variable Speed Control

Operator can choose any speed from the slowest creep to full throttle. The heaviest loads can be positioned quickly and accurately, or raised rapidly. Features an external screw adjustment for lift and descent speeds.

### Pendant Type Control

Leaves the operator one hand free to guide the load with precise control. Preferred compact design and easy handling.

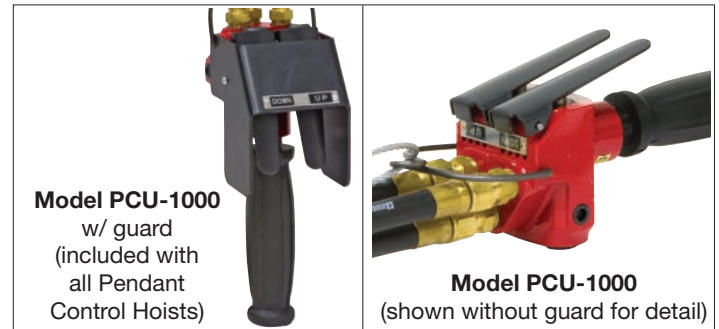

**Model PCU-1000**  
w/ guard  
(included with  
all Pendant  
Control Hoists)

**Model PCU-1000**  
(shown without guard for detail)

### Caution

**This equipment is not to be used for lifting, supporting or transporting people, or for lifting or supporting loads over people.**

Model No.	Chain Type	Capacity	Control	Standard Lift	No. of Falls	Std. Load Chain	Headroom	Lift Speed at Capacity	Weight (Lbs.)	Rec'd Hose Size	Air Inlet Thread	CFM
RHL-250 RHL-250P	Link	550 lbs.	Pullcord Pendant	8 ft.	1	9 ft.	17"	88.6 ft./min.	35.2 39.6	1/2"	1/2"	45.9
RHL-500 RHL-500P	Link	1100 lbs.	Pullcord Pendant	8 ft.	1	9 ft.	17"	41.3 ft./min.	35.2 39.6	1/2"	1/2"	45.9
RHL-1000 RHL-1000P	Link	2200 lbs.	Pullcord Pendant	8 ft.	2	18 ft.	20"	18.7 ft./min.	48.4 51.7	1/2"	1/2"	45.9
RHL-2800	Link	6160 lbs.	Pullcord	10 ft.	2	25 ft.	28"	7.2 ft./min.	132.0	3/4"	1/2"	60.0

**Extra lift can be installed for an additional charge. Link chain hoists equipped with chain basket. Most parts for the above hoists are interchangeable with ARO, Chicago Pneumatic and Yale hoists.**



Stock No. 101704

## JET SMH Series Hand Chain Hoists

- Full range capacity 1/2 to 10-tons
- Standard features found only in higher priced models
- Economical hand chain hoist designed for years of trouble-free service
- All steel construction with a durable powder coat finish
- Lightweight, compact design for low headroom applications
- Needle bearing supported load sheave for smooth operation
- Completely enclosed Weston type automatic brake system for precise load spotting
- Triple-spur gears provide high efficiency ratio with minimum effort
- Induction hardened grade 80 load chain
- Drop forged hooks with heavy-duty safety latches swivel 360° for easy rigging
- Smooth rolled edge on hand chain cover prevents side pull jamming
- Standard hand chain drop equals lift length
- Proof tested with test certificate
- Complies with OSHA, ANSI/ASME B30.16 and HST-2 standards

### CAUTION

Be sure that the supporting structures and load-attaching devices used in conjunction with this hoist provide an adequate safety factor to handle the rated load plus the weight of the equipment. If in doubt, consult a qualified structural engineer. **This equipment is not to be used for lifting, supporting or transporting people, or lifting or supporting loads over people.**

### IMPORTANT

Before installation, read owner's manual for additional warnings and precautions. Not for use in an explosive environment.

Stock No.	Model	Capacity (Lbs.)	Standard Lift (Ft.)	Headroom (In.)	Number of Falls	Load Chain (Dia./MM)	Req. Hand Chain (Ft.) to Lift Load 1'	Pounds Pull to Lift Capacity	Ship Weight (Lbs.)
101700	SMH-1/2T-10	1100	10	13	1	5.0	32	49	20
101702	SMH-1/2T-20		20						29
101704	SMH-1T-10	2200	10	15	1	6.3	37	80	27
101706	SMH-1T-20		20						38
101708	SMH-1-1/2T-10	3520	10	17-1/2	1	7.0	58	82	41
101710	SMH-1-1/2T-20		20						56
101712	SMH-2T-10	4400	10	18-1/2	1	8.0	70	91	46
101714	SMH-2T-20		20						60
101716	SMH-3T-10	6820	10	23-1/2	2	7.0	116	86	60
101718	SMH-3T-20		20						80
101720	SMH-5T-10	11000	10	28	2	9.0	172	97	91
101722	SMH-5T-20		20						122
101724	SMH-10T-10	22000	10	35	4	9.0	344	104	177
101726	SMH-10T-20		20						232



Stock No. 101505

## JET L-90 Series

### Hand Chain Hoists

- Full range capacity 1/2 to 10-tons
- Compact and portable for ease of positioning material
- Engineered for commercial and industrial lifting applications
- All steel construction with a durable powder coat finish
- Lightweight, compact design for low headroom applications
- Completely enclosed Weston type automatic brake system for positive load spotting
- Triple-spur gears provide high efficiency ratio with minimum effort
- Heat treated and hardened grade 80 load chain
- Smooth rolled edge on hand chain cover prevents side pull jamming
- Wide throat drop forged safety hooks for easier rigging
- Standard hand chain drop equals lift length
- Proof tested with test certificate
- Complies with OSHA, ANSI/ASME B30.16 and HST-2 standards

#### CAUTION

Be sure that the supporting structures and load-attaching devices used in conjunction with this hoist provide an adequate safety factor to handle the rated load plus the weight of the equipment. If in doubt, consult a qualified structural engineer. **This equipment is not to be used for lifting, supporting or transporting people, or lifting or supporting loads over people.**

#### IMPORTANT

Before installation, read owner's manual for additional warnings and precautions. Not for use in an explosive environment.

Stock No.	Model	Capacity (Lbs.)	Standard Lift (Ft.)	Headroom (In.)	Number of Falls	Load Chain (Dia./MM)	Req. Hand Chain (Ft.) to Lift Load 1'	Pounds Pull to Lift Capacity	Ship Weight (Lbs.)
101505	L-90-1/2T-10	1100	10	10-3/4	1	5.0	29	59	23
101306	L-90-1/2T-20		20						32
101510	L-90-1T-10	2200	10	11-3/4	1	6.3	50	69	29
101311	L-90-1T-20		20						40
101515	L-90-1-1/2T-10	3520	10	13-1/4	1	7.1	60	91	37
101316	L-90-1-1/2T-20		20						52
101520	L-90-2T-10	4400	10	14-3/4	1	8.0	77	88	48
101320	L-90-2T-20		20						63
101530	L-90-3T-10	6820	10	20-7/8	2	7.1	120	88	56
101330	L-90-3T-20		20						75
101550	L-90-5T-10	11000	10	24-1/2	2	9.0	190	106	97
101350	L-90-5T-20		20						132
101560	L-90-10T-11-1/2	22000	11-1/2	30-1/2	4	9.0	385	116	209
101565	L-90-10T-20		20						242

## JET L-100 Series

### Hand Chain Hoists

- Full range capacity 1/2 to 10-tons
- Compact and portable for ease of positioning material
- Engineered for commercial and industrial lifting applications
- All steel construction with a durable powder coat finish
- Lightweight, compact design for low headroom applications
- Completely enclosed Weston type automatic brake system for positive load spotting
- Triple-spur gears provide high efficiency ratio with minimum effort
- Heat treated and hardened grade 80 load chain
- Smooth rolled edge on hand chain cover prevents side pull jamming
- Wide throat drop forged safety hooks for easier rigging
- Standard hand chain drop equals lift length
- Proof tested with test certificate
- Complies with OSHA, ANSI/ASME B30.16 and HST-2 standards

#### CAUTION

Be sure that the supporting structures and load-attaching devices used in conjunction with this hoist provide an adequate safety factor to handle the rated load plus the weight of the equipment. If in doubt, consult a qualified structural engineer. **This equipment is not to be used for lifting, supporting or transporting people, or lifting or supporting loads over people.**

#### IMPORTANT

Before installation, read owner's manual for additional warnings and precautions. Not for use in an explosive environment.

**OVERLOAD**  
PROTECTION



Stock No. 107100

Stock No.	Model	Capacity (Lbs.)	Standard Lift (Ft.)	Headroom (In.)	Number of Falls	Load Chain (Dia./MM)	Req. Hand Chain (Ft.) to Lift Load 1'	Pounds Pull to Lift Capacity	Ship Weight (Lbs.)
104100 205120	L-100-50WO-10 L-100-50WO-20	1100	10 20	11-1/4	1	5.0	25	53	24.00 34.00
102100 203120	L-100-1TWO-10 L-100-1TWO-20	2200	10 20	11-5/8	1	6.3	43	64	27.00 39.25
101100 201120	L-100-150WO-10 L-100-150WO-20	3300	10 20	13-3/4	1	7.1	57	77	34.25 48.00
105100 206120	L-100-200WO-10 L-100-200WO-20	4400	10 20	14-3/4	1	8.0	70	79	44.00 59.00
106100 207120	L-100-300WO-10 L-100-300WO-20	6600	10 20	20-1/8	2	7.1	114	79	53.00 74.00
107100 208120	L-100-500WO-10 L-100-500WO-20	11000	10 20	23-5/8	2	9.0	198	75	90.00 119.50
108100 209120	L-100-1000WO-10 L-100-1000WO-20	22000	10 20	29-7/8	4	9.0	396	79	174.00 227.00



## JET JLH Series

### Lever Hoists

- 3/4-ton to 6-ton Capacities
- Available in 5ft, 10ft, and 20ft lifts
- Light weight, compact design for low head room applications
- All units feature premium 100 grade chain for extreme wear resistance
- Patented fused break disc design for low maintenance
- Caged roller bearings used on load sprocket increase ease of use and efficiency
- Lever Hoist with Overload Protection

### CAUTION

Be sure that the supporting structures and load-attaching devices used in conjunction with this hoist provide an adequate safety factor to handle the rated load plus the weight of the equipment. If in doubt, consult a qualified structural engineer. **This equipment is not to be used for lifting, supporting or transporting people, or lifting or supporting loads over people.**

### IMPORTANT

Before installation, read owner's manual for additional warnings and precautions. Not for use in an explosive environment.



Stock No. 210010

Stock No.	Model No.	Capacity (Tons)	Capacity (Lbs.)	Standard Lift (Ft.)	Headroom (In.)	Number of Falls	Load Chain (dia/mm)	Lever Length (In.)	Pounds of Pull To Lift Capacity	Lift Per Full Turn of Lever (In.)	Weight (Lbs.)
375005	JLH-80WO-5	0.8	1760	5	11	1	5.6	9-5/8	64	1-1/8	12.50
375010	JLH-80WO-10			10							
375020	JLH-80WO-20			20							
315005	JLH-160WO-5	1.6	3520	5	13.1	1	7.1	10-3/8	75	7/8	17.50
315010	JLH-160WO-10			10							
315020	JLH-160WO-20			20							
330050	JLH-320WO-5	3.2	7040	5	15.5	1	10	16-5/16	82	3/4	30.00
330100	JLH-320WO-10			10							
330200	JLH-320WO-20			20							
360005	JLH-630WO-5	6.3	13860	5	21.2	1	10	16-5/16	84	3/8	57.25
360010	JLH-630WO-10			10							
360020	JLH-630WO-20			20							



## JET JLP Series

### Lever Hoists

- Economical lever hoist designed for years of trouble-free operation
- 3/4-ton to 6-ton capacities
- 5', 10', and 20' lifts available
- All steel construction with a durable powder coat finish
- Completely enclosed Weston type automatic brake system holds load in any position
- Easy-to-use with single hand operation and control
- Simple design makes routine inspection and maintenance easy
- Freewheeling feature without load for quick load attachment
- Hardened grade 80 low wear chain
- Drop forged hooks with heavy-duty safety latches swivel 360° for easy rigging
- Proof tested with test certificate
- Complies with OSHA, ANSI/ASME B30.21 and HST-3 standards

### CAUTION

Be sure that the supporting structures and load-attaching devices used in conjunction with this hoist provide an adequate safety factor to handle the rated load plus the weight of the equipment. If in doubt, consult a qualified structural engineer. **This equipment is not to be used for lifting, supporting or transporting people, or lifting or supporting loads over people.**

### IMPORTANT

Before installation, read owner's manual for additional warnings and precautions. Not for use in an explosive environment.



Stock No. 187711

Stock No.	Model	Rated Capacity (Ton)	Standard Lift (Ft.)	Min. Distance Between Hooks (In.)	No. of Falls	Load Chain (Dia./MM)	Lever Length (In.)	Pounds Pull to Lift Capacity	Lift Per Full Turn of Lever (In.)	Ship Weight (Lbs.)	
187707	JLP-75-5	3/4	5	12-7/16	1	6	10-1/4	32	3/4	17	
187708	JLP-75-10		10							20	20
187710	JLP-75-20		20							25	
187711	JLP-150-5	1-1/2	5	14	1	8	16-1/8	42	7/8	28	
187712	JLP-150-10		10							33	
187714	JLP-150-20		20							43	
187715	JLP-300-5	3	5	19-3/4	1	10	16-1/8	72	5/8	46	
187716	JLP-300-10		10							54	
187718	JLP-300-20		20							69	
187719	JLP-600-5	6	5	24-7/16	2	10	16-1/8	76	5/8	68	
187720	JLP-600-20		20							113	

## JET PT Series Industrial-Duty Plain Trolleys

- Designed for low maintenance and trouble-free operation through a wide range of beams
- 1/2 ton to 10-ton capacity
- For use with wide-flange H-beams, standard I-beams, or curved track
- Multiple spacer washers make beam flange width adjustment quick and easy
- Rugged steel side plates feature built-in bumper guards
- Hardened wheels with lubricated for life, double sealed ball bearings
- Proof tested with test certificate
- Compliance: OSHA, ANSI/ASME B30.11 and B30.17 standards



Stock No. 252015

Stock No.	Model	Capacity (Ton)	Beam Flange Width (In.)	Beam Height (Ft.)	Min. Radius Curve (In.)	Ship Weight (Lbs.)
252005	1/2 PT	1/2	2-1/2 – 8		39	20
252010	1 PT	1	3 – 8		39	34
252015	1-1/2 PT	1-1/2	3-1/4 – 8		43	43
252020	2 PT	2	3-1/4 – 8	4 – 19	43	52
252030	3 PT	3	4 – 8		51	88
252050	5 PT	5	4-5/6 – 8		55	129
252060	10 PT	10	4-3/4 – 8		67	213

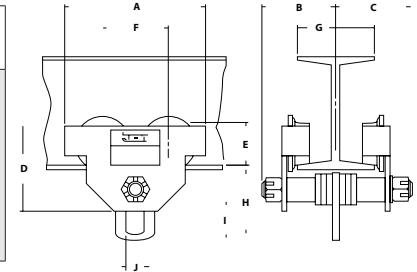

### Dimensions (In.)

Model	A	B	C	D	E	F	G	H	I	J
1/2 PT	8-3/8"	6-3/16"	6-3/16"	5-1/8"	2-5/16"	4"	2-1/2" – 8	4"	1-9/16"	15/16"
1 PT	9-15/16"	6-1/2"	6-1/2"	6-1/8"	2-15/16"	4-5/8"	3" – 8	4-1/2"	1-15/16"	1-3/16"
1-1/2 PT	10-7/8"	6-5/8"	6-5/8"	6-3/8"	3-3/8"	4-7/8"	3-1/4" – 8	5-1/8"	2-1/2"	1-5/16"
2 PT	11-7/8"	6-7/8"	6-7/8"	6-11/16"	3-9/16"	5-3/8"	3-1/4" – 8	5-1/4"	2-9/16"	1-7/16"
3 PT	13-5/8"	7-5/16"	7-5/16"	8-9/16"	4-5/16"	6-3/16"	4" – 8	6-5/8"	3"	1-3/4"
5 PT	15-1/16"	7-7/8"	7-7/8"	10-1/16"	4-13/16"	6-3/4"	4-5/8" – 8	7-7/8"	3-13/16"	2-3/8"
10 PT	17-15/16"	8-1/2"	8-1/2"	11-5/8"	5-15/16"	7-7/8"	4-3/4" – 8	10-1/8"	5"	3-1/4"

## JET SBC Series Industrial-Duty Beam Clamps

- For construction, commercial and industrial vertical or horizontal rigging operations
- 1-ton to 5-ton capacities
- Mount hoists or lift beams with portable lightweight clamp
- Adjusts with ease to fit a broad range of wide-flange H or standard I-beams
- Clamp jaw designed to distribute the load away from beam flange edge
- Low headroom with built-in suspension rod
- Proof tested with test certificate
- Compliance: ANSI/ASME B30.17 and B30.20 standards



Stock No. 252720

### CAUTION

Read owners manual for additional warnings and precautions before use. Failure to read, understand and follow all instructions can result in serious injury. Do not exceed rated capacity. Use clamp only if authorized and properly trained. Do not move unbalanced load. Not for use in explosive environment.

Stock No.	Model	Capacity (Lbs.)	Beam Flange Width (In.)	Ship Weight (Lbs.)
252710	JBC-1	2000	2-31/32-8-21/32	12 lbs.
252720	JBC-2	4000	2-31/32-8-21/32	14 lbs.
252730	JBC-3	6000	3-15/16-9-2/32	27 lbs.
252750	JBC-5	10000	4-15/16-10-5/8	34 lbs.

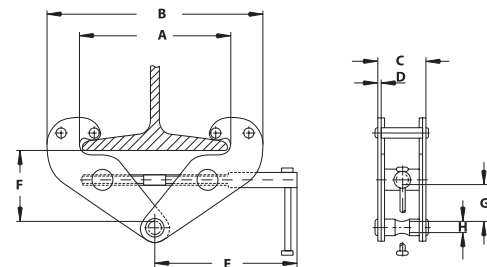

### Dimensions (In.)

Model	Dim. (In.) Max A	Min B	Max. B	C	D	E	Max. F	Min. F	Min. G	H
JBC-1	9-21/32	7-3/32	14-11/64	2-3/4	13/64	9-9/32	5-5/16	3-35/64	1-3/16	13/16
JBC-2	9-21/32	7-3/32	14-11/64	2-29/32	1/4	9-9/32	5-5/16	3-35/64	1-3/16	13/16
JBC-3	11-5/8	9-27/32	17-11/32	4/-21/32	5/16	10-1/4	6-11/16	4-11/32	2-11/64	1
JBC-5	11-7/32	10-7/16	19-3/32	5-1/2	25/64	10-1/4	6-15/16	4-15/16	2-3/64	1-7/64

## JET JHJ Series

### Heavy-Duty Industrial Bottle Jacks

- For lifting, pushing, spreading, bending, pressing or straightening requirements
- Not affected by temperature extremes
- Low profile truck models or standard models
- Electrically welded base and cylinders to assure strength and eliminate leaks
- All models work in upright, angle or horizontal position
- Pump handle included
- Carrying handles on 12-1/2 to 100-ton models
- Complies with ANSI/ASME B30.1 and PALD-1 standards



Stock No.	Model	Rated Capacity (Ton)	Minimum Height (In.)	Piston Height (In.)	Head Screw (H/In.)	Max. Height (In.)	Base Size (LXW/In.)	Ship Weight (Lbs.)
453301	JHJ-2	2	7-1/8	4-1/2	2	13-5/8	4-1/2 x 2-1/2	5
453303	JHJ-3	3	7-1/2	4-1/2	2-3/8	14-3/8	4-9/16 x 2-13/16	6
453305	JHJ-5	5	7-7/8	4-5/8	2-3/4	15-1/2	5-5/8 x 3-1/4	9
453308	JHJ-8	8	7-7/8	4-5/8	2-3/4	15-1/2	6 x 3-1/2	13
453312	JHJ-12 1/2	12-1/2	9-1/2	5-7/8	3-1/8	18-1/2	6-1/2 x 4-1/8	18
453313K	JHJ-12 1/2L	12-1/2	6-3/4	3-3/4	3	13-3/8	6-1/2 x 4-1/8	15
453317	JHJ-17 1/2	17-1/2	10-3/8	6-1/2	3-1/8	20	7-1/8 x 4-5/8	24
453318K	JHJ-17 1/2L	17-1/2	6-3/4	3-1/2	2-3/4	13	7-1/8 x 4-5/8	19
453322	JHJ-22 1/2	22-1/2	10-5/8	6-1/4	-	16-7/8	7-1/8 x 5-1/2	28
453323K	JHJ-22 1/2L	22-1/2	7-1/8	3-3/8	1-1/2	12	7-1/4 x 5-1/16	23
453335K	JHJ-35	35	11	6-1/4	-	17-1/4	8-3/8 x 5-1/2	48
453360K	JHJ-60	60	12	6-3/4	-	8-5/8	9-1/4 x 7-3/8	82
453399K	JHJ-100	100	12	5-23/32	-	17-11/16	14-31/32 x 10-7/16	225

## JET PTX & JTX Series

### Pallet Trucks

- One-piece cast pump features high quality seals, hardened and chrome plated ram and piston, top-of stroke and overload bypass valves
- Rounded fork tips with nylon guide rollers for trouble-free pallet entry and exit
- Solid steel push rod never needs adjustment
- 210° turning radius
- Large 8" poly over aluminum steering wheels feature double sealed, life time lubricated bearings (*JTX Model*)
- 2-1/2" turning radius (*PTX Model*)

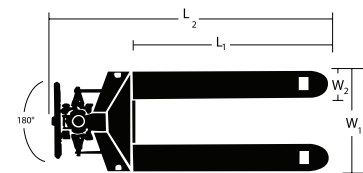
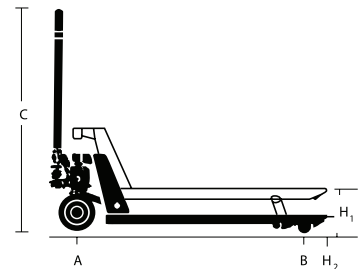

### Dimensions (In.)

Stock No.	Model	Capacity	W1	W2	L1	L2	H1	H2	A	B	C	Ship Weight (Lbs.)
140093	PTX-2748	5500 lbs.	27	6	48	63	6-1/4	2-1/2	7 x 2	2-1/2 x 3-3/4	47-1/4	196
140800	JTX-2748	8000 lbs.	27	6-1/4	48	63-1/2	6-1/4	3-1/4	8 x 2	3-1/4 x 3-1/2	49-1/4	240

# Air Tuggers



Michigan Pneumatic

## Short Drum Tuggers

Light, compact tuggers designed for low air consumption and high efficiency. Can be mounted to a wall, floor or ceiling. Can also be mounted to a portable compressor and moved from one job to another. **\*Allow 120 days for delivery.**



Model MP-W05AA3SACMB



Model MP-W10220SACMB



Model MP-W20220SACMB

### Michigan Pneumatic Manual Brake Models

Short Drum Model No.	Capacity	Line Speed @ Capacity	Cable Capacity						Air Inlet Thread	Weight w/o Rope
			1/4"	5/16"	3/8"	7/16"	1/2"	5/8"		
MP-W05AA3SACMB	1100 lbs.	62 ft.	213 ft.	147 ft.	-	-	-	-	3/4"	97 lbs.
MP-W10220SACMB	2200 lbs.	121 ft.	-	-	688 ft.	475 ft.	383 ft.	-	1"	566 lbs.
MP-W20220SACMB	4400 lbs.	62 ft.	-	-	-	476 ft.	384 ft.	-	1"	586 lbs.
MP-W3036SACMB	6600 lbs.	62 ft.	-	-	-	-	-	525 ft.	1-1/4"	1035 lbs.



Model MP-W10220SAAB



Model MP-W20220SAAB



### Drum Guards

Part No.	Fits Tool Model No.
E302-104G	MP-W05 Series
E398-003G	MP-W10220LAAB
	MP-W10220LACMB
	MP-W20220LAAB
	MP-W20220LACMB
E398-001G	MP-W10220SAAB
	MP-W10220SACMB
	MP-W20220SAAB
	MP-W20220SACMB
E398-007G	MP-W3036LAAB
	MP-W3036LACMB
E305-013G	MP-W5036LAAB
	MP-W5036LACMB

### Michigan Pneumatic Automatic Brake Models

Short Drum Model No.	Capacity	Line Speed @ Capacity	Cable Capacity						Air Inlet Thread	Weight w/o Rope
			1/4"	5/16"	3/8"	7/16"	1/2"	5/8"		
MP-W05AA3SAAB *	1100 lbs.	62 ft.	213 ft.	147 ft.	-	-	-	-	3/4"	104 lbs.
MP-W10220SAAB	2200 lbs.	121 ft.	-	-	688 ft.	475 ft.	383 ft.	-	1"	588 lbs.
MP-W20220SAAB *	4400 lbs.	62 ft.	-	-	-	476 ft.	384 ft.	-	1"	608 lbs.
MP-W3036SAAB *	6600 lbs.	62 ft.	-	-	-	-	-	525 ft.	1-1/4"	1066 lbs.

# Air Tuggers



Michigan Pneumatic

## Long Drum Tuggers

Light, compact tuggers designed for low air consumption and high efficiency. Can be mounted to a wall, floor or ceiling. Can also be mounted to a portable compressor and moved from one job to another. **\*Allow 120 days for delivery.**

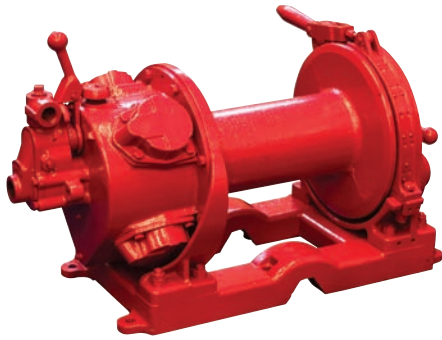

Model MP-HUL



Model MP-W3036LACMB

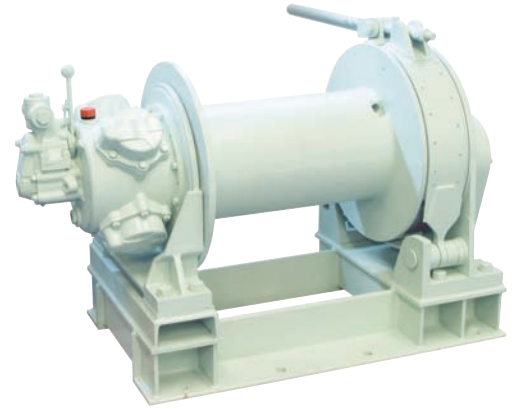

Model MP-W5036LACMB  
4 Piston Unit (shown)

**NEW MODEL**

Model MP-W5045LACMB  
5 Piston Unit (not shown)

### Michigan Pneumatic Manual Brake Models

Long Drum Model No.	Capacity	Line Speed @ Capacity	Cable Capacity						Air Inlet Thread	Weight w/o Rope
			3/8"	7/16"	1/2"	5/8"	3/4"	7/8"		
MP-HUL	2000 lbs.	110 ft.	1445 ft.	1012 ft.	813 ft.	-	-	-	1"	562 lbs.
MP-W10220LACMB	2200 lbs.	121 ft.	1378 ft.	951 ft.	768 ft.	-	-	-	1"	608 lbs.
MP-W20220LACMB	4400 lbs.	62 ft.	-	952 ft.	768 ft.	-	-	-	1"	632 lbs.
MP-W3036LACMB	6600 lbs.	62 ft.	-	-	-	1050 ft.	-	-	1-1/4"	1130 lbs.
MP-W5036LACMB	11000 lbs.	36 ft.	-	-	-	-	820 ft.	755 ft.	1-1/4"	1890 lbs.
MP-W5045LACMB	11000 lbs.	59 ft.	-	-	-	-	-	750 ft.	2"	1958 lbs.



Model MP-W20220LAAB



Model MP-W3036LAAB

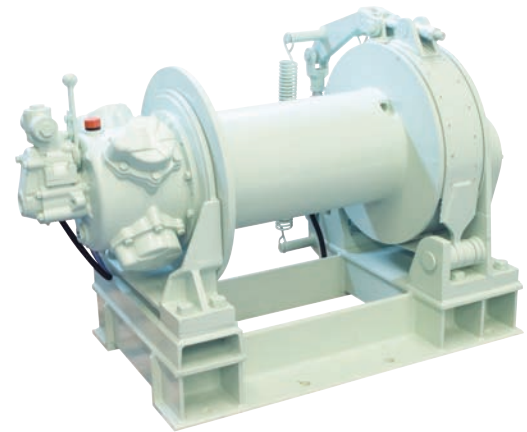

Model MP-W5036LAAB

### Michigan Pneumatic Automatic Brake Models

Long Drum Model No.	Capacity	Line Speed @ Capacity	Cable Capacity						Air Inlet Thread	Weight w/o Rope
			3/8"	7/16"	1/2"	5/8"	3/4"	7/8"		
MP-W10220LAAB *	2200 lbs.	121 ft.	1378 ft.	951 ft.	768 ft.	-	-	-	1"	635 lbs.
MP-W20220LAAB *	4400 lbs.	62 ft.	-	952 ft.	768 ft.	-	-	-	1"	654 lbs.
MP-W3036LAAB *	6600 lbs.	62 ft.	-	-	-	1050 ft.	-	-	1-1/4"	1161 lbs.
MP-W5036LAAB	11000 lbs.	36 ft.	-	-	-	-	820 ft.	755 ft.	1-1/4"	1923 lbs.

Remote control units available for most models.

# Tool Balancers



## Michigan Pneumatic Tool Balancers

Applied ergonomics makes load weightless. Features reinforced hanging bracket with safety hook for ceiling mounting and extra holes for safety chain attachments.



Model No.	Tension Range	Cable Travel	Min. Hook to Hook Dist.	Cable Material	Weight
MP-2BAL	0-2 lbs.	6 ft.	11-1/2"	Uncoated Steel	1.25 lbs.
MP-4BAL	2-4 lbs.				
MP-7BAL	4-7 lbs.				

## Michigan Pneumatic Model BM-SK3 Torque Reaction Arm

Bench mounted telescoping reaction arm eliminates sidekick torque up to 200 in.-lbs. Bolts directly to workspace. **Other styles available. All accessories except the screwdriver are included as shown.**



BC-1062

Optional Bench Clamp

Range of Motion ..... 360° In Most Planes  
Working Radius ..... 16" to 32"  
Tool Support Range..... Up to 5 lbs.

## Michigan Pneumatic Hubbell Balancers

Applied ergonomics makes load weightless. Features reinforced hanging bracket with safety hook for ceiling mounting and extra holes for safety chain attachments. **Locking models available.**

Model No.	Tension Range	Cable Travel	Min. Hook to Hook Dist.	Cable Material	Weight
MP-BD01	0.5-1.5 lbs.	5 ft.	9-1/4"	Coated Steel	1.25 lbs.
MP-BD03	1.5-3 lbs.				1.25 lbs.
MP-BD05	3-5 lbs.				1.50 lbs.
MP-BG07	5-10 lbs.	8 ft.	13-7/8"	Coated Steel	6 lbs.
MP-BG10	8-12 lbs.				7 lbs.
MP-BG15	10-15 lbs.				8 lbs.
MP-BG20	16-23 lbs.				8 lbs.

MADE  
U.S.A.  
IN THE



BD Series



BG Series

## Michigan Pneumatic Heavy-Duty Tool Balancers

Rugged, compact, precision engineered tool balancers designed to improve productivity while reducing maintenance costs of small tools and operator fatigue. Smooth tension through the full cable length, plus an adjustment knob for tension control is your assurance of the safest, most reliable tool balancer. Keeps tools always at the ready with no lifting and no wasted motion.

- Heavy-duty all steel construction.
- Simple external tension adjustment.
- Adjustable cable stop for convenient operation.
- Ready for immediate installation with tool clip.
- Automatic safety lock.
- Self-contained mainspring.

Model No.	Tension Range	Cable Travel	Min. Hook to Hook Dist.	Cable Material	Weight
MP-BL02	1-3.5 lbs.	8 ft.	10-1/4"	Nylon	2.75 lbs.
MP-BL05	2-4.5 lbs.		10-1/4"		2.75 lbs.
MP-BL08	4.5-8 lbs.		10-1/4"		3 lbs.
MP-BL10	6.5-13.5 lbs.		12-5/8"		3 lbs.
MP-BL15	11-19 lbs.		12-5/8"		3.5 lbs.
MP-BL25	18-25 lbs.		12-5/8"		3.5 lbs.



BL Series





Michigan Pneumatic

## Low Range Balancers

Lightweight Steel Construction

- Balance Range 1.1 - 3.3 lbs.
- 3/32" diameter steel cable.

Standard reel type spring balancer for light loads.



Model No.	Tension Range	Cable Travel	Min. Hook to Hook Dist.	Weight
MP-SW-1	1.1-3.3 lbs.	3.9 ft.	9-1/4"	1.1 lbs.

Michigan Pneumatic

## Medium-Duty Balancers

Cast Aluminum Construction

- Balance Range 2.2 - 14.3 lbs.
- 1/8" diameter steel cable.
- 360° swivel hook.

Tapered drum spring balancer for production use. The tapered drum minimizes tension build-up as the cable is extended. Ideal for small assembly operations.



Model No.	Tension Range	Cable Travel	Min. Hook to Hook Dist.	Weight
MP-SW-3	2.2-6.6 lbs.	4.2 ft.	11-3/8"	3.0 lbs.
MP-SW-5	5.5-11 lbs.			3.3 lbs.
MP-SW-6.5	6.6-14.3 lbs.			3.5 lbs.

Michigan Pneumatic

## Heavy-Duty Balancers

Cast Aluminum Construction

- Balance Range 9.9 - 33 lbs.
- 3/16" diameter steel cable.
- 360° swivel hook.

Ideal for jobs up to 33 lbs. where reel style balancers fail. The tapered drum minimizes tension build-up as the cable is extended.



Model No.	Tension Range	Cable Travel	Min. Hook to Hook Dist.	Weight
MP-SW-9	9.9-19.8 lbs.	4.2 ft.	13-1/4"	7.4 lbs.
MP-SW-15	19.8-33 lbs.			8.3 lbs.

Michigan Pneumatic

## Heavy-Duty High Capacity Balancers

Cast Aluminum Construction

- Balance Range 33 - 154 lbs.
- 7/32" diameter steel cable.
- 360° swivel hook.

Designed for automobile assembly, meatpacking and steel manufacturing plants. The tapered drum minimizes tension build-up as the cable is extended.



Model No.	Tension Range	Cable Travel	Min. Hook to Hook	Weight
MP-SW-22	33.07-48.5 lbs.	4.9 ft.	16-5/8"	15.9 lbs.
MP-SW-30	48.4-66 lbs.			16.7 lbs.
MP-SW-40	66-88 lbs.			21.5 lbs.
MP-SW-50	88-110 lbs.			22.8 lbs.
MP-SW-60	110-132 lbs.			25.5 lbs.
MP-SW-70	132-154 lbs.			25.9 lbs.

Aero-Motive Model 15F

## Heavy-Duty Steel Balancer

- Easy tension adjustment
- Durable 3/32" diameter stranded steel aircraft cable
- Long-lasting mainspring

Industrial model designed for repetitive assembly line work, steel manufacturing plants and machine shops.



Model No.	Tension Range	Cable Travel	Min. Hook to Hook Dist.	Weight
15F	8-15 lbs.	8 ft.	15-1/4"	8.8 lbs.

Michigan Pneumatic

## Auto Rewind Hose Reel

Lightweight, impact resistant polypropylene construction, UV stabilized for outside applications. Features a positive locking mechanism which enables hose to lock at any length. Can be installed at any position on a wall, ceiling or vehicle. **Includes 50 ft. of 3/8" I.D. superflex outlet hose and 3 ft. of 3/8" I.D. inlet hose, heavy-duty mounting bracket and carrying handle.**



**Model RC2000-10**  
50 ft.  
3/8" Hose

# Clamps



Michigan Pneumatic

## Industrial Quality "C" Clamps

Spatter Resistant Deep Throat

The extra deep throat allows maximum clearance for body builders, welders (weld spatter will not stick to the copper plated screw and swivel), wood workers and general machine shop workers. Drop forged and heat treated with a tough Acme thread for long life and durable performance.



Model No.	Capacity	Throat Depth	Length	Width	Screw Diameter
CC402	2"	2"	6"	3-3/4"	1/2"
CC403	3"	2-1/2"	8"	4-1/4"	5/8"
CC404	4"	2-7/8"	10"	5"	3/4"
CC406	6"	3-5/8"	12"	6"	3/4"
CC408	8"	4-1/2"	14-1/2"	7"	3/4"
CC410	10"	5-3/8"	17-1/4"	8-1/2"	3/4"
CC412	12"	5-3/4"	20"	9-3/8"	7/8"

Michigan Pneumatic

## Heavy-Duty Forged "C" Clamps

Heaviest Clamp Made

Features a heat treated, drop forged frame and tempered steel spindles turned from bar stock. Also includes an unconditional guarantee against breakage, natural finish and bulk packaging. Heat treated screws and square heads provide for use of wrenches.



Model No.	Capacity	Throat Depth	Screw Diameter	Min. Test Load	Weight
CC1H	1-1/4"	1-1/8"	3/8"	5600 lbs.	1 lb.
CC112H	1-1/2"	1-3/8"	1/2"	9000 lbs.	2 lbs.
CC2H	2-1/2"	1-1/2"	5/8"	13500 lbs.	4 lbs.
CC3H	3-1/2"	2-1/4"	3/4"	17000 lbs.	7 lbs.
CC4H	4-1/2"	2-3/4"	7/8"	20000 lbs.	10 lbs.
CC5H	5-1/2"	3-1/8"	1"	23000 lbs.	15 lbs.
CC6H	6-1/2"	3-1/2"	1-1/8"	27000 lbs.	18 lbs.
CC8H	8-1/2"	3-3/4"	1-1/4"	31250 lbs.	25 lbs.
CC10H	10-1/2"	4-1/8"	1-1/4"	35000 lbs.	30 lbs.
CC12H	12-1/2"	4-1/2"	1-1/2"	40000 lbs.	35 lbs.

## Michigan Pneumatic Forged Steel Machine Strap Clamps



U-Series Strap Clamps

Model No.	Length	Width	Thickness	Slot Width	Slot Length	Offset	Approx. Weight
UC-64	4"	1-3/4"	3/4"	11/16"	3-1/2"	-	1 lb.
UC-66	6"	2"	7/8"	11/16"	5-1/2"	-	2 lbs.
UC-68	8"	2-3/8"	1-1/8"	13/16"	7-3/8"	-	4 lbs.
UC-110	10"	2-3/4"	1-1/4"	15/16"	9"	-	6.5 lbs.
UC-112	12"	3-1/4"	1-3/8"	1-1/16"	11"	-	11 lbs.



Finger-Series Strap Clamps

Model No.	Length	Width	Thickness	Slot Width	Slot Length	Offset	Approx. Weight
FC-44	4"	1-3/8"	3/4"	11/16"	1-3/8"	-	.75 lb.
FC-46	6"	1-3/4"	7/8"	11/16"	1-15/16"	-	1.5 lbs.
FC-48	8"	2-1/8"	1-1/8"	13/16"	2-9/16"	-	3 lbs.



Plain-Series Strap Clamps

Model No.	Length	Width	Thickness	Slot Width	Slot Length	Offset	Approx. Weight
PC-54	4"	1-5/8"	3/4"	11/16"	1-3/8"	-	1 lb.
PC-56	6"	1-3/4"	7/8"	11/16"	2-1/16"	-	1.75 lbs.
PC-58	8"	2-1/8"	1-1/8"	13/16"	2-13/16"	-	3.75 lbs.
PC-59	10"	2-1/2"	1-3/8"	15/16"	3-11/16"	-	7 lbs.



Gooseneck-Series Strap Clamps

Model No.	Length	Width	Thickness	Slot Width	Slot Length	Offset	Approx. Weight
GC-74	4"	1-3/8"	3/4"	11/16"	15/16"	13/16"	1 lb.
GC-76	6"	1-3/4"	7/8"	11/16"	1-11/16"	15/16"	2 lbs.
GC-78	8"	2-1/8"	1-1/8"	13/16"	2-7/16"	1-1/8"	4.25 lbs.



# Miscellaneous Tools



## Wilton® Heavy-Duty Vises

Rugged, dependable, economically priced general purpose vises. Features locking swivel base, replaceable jaws, fabricated steel construction, built-in anvil with horn and pipe jaws.

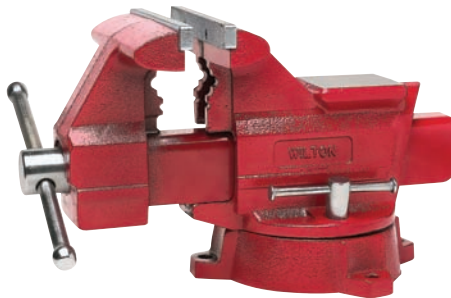

600648HD

Model No.	Jaw Width	Jaw Opening	Throat Depth	Pipe Jaw	Weight
600674	4-1/2"	4"	2-5/8"	1/8" to 2"	19.40 lbs.
600675	5-1/2"	5"	3-5/16"	1/8" to 2-1/2"	29.20 lbs.
600676	6-1/2"	5-1/2"	3-13/16"	1/8" to 2-1/2"	41.85 lbs.
600656HD	6"	6"	3-1/2"	1/8" to 3"	64.10 lbs.
600648HD	8"	7-1/2"	4-1/2"	1/8" to 3"	86.20 lbs.

## Michigan Pneumatic Model MP-290-ST Air Caulking Gun

Produces a constant flow for an even bead. Ideal for construction and automotive applications.



Max. Air Pressure .....	70 psi
Air Inlet Thread .....	1/4"
Tube Size .....	2" dia. x 8-1/2" lg.

## JET Toe & Screw Jacks

### Screw Jacks

Model No.	Rated Capacity	Screw Size	Base Size	Closed Height	Extended Height
SJ-5T	5 ton	1" x 6"	4-1/2"	9"	13"
SJ-10T	10 ton	1-1/2" x 8-3/8"	5-1/4"	11"	17-1/2"
SJ-15T	15 ton	1-5/8" x 10-1/2"	6"	13-3/4"	21"
SJ-20T	20 ton	2" x 12"	6-7/8"	16"	25"
SJ-25T	25 ton	2-1/2" x 12"	8"	16-1/2"	25-1/4"

### Turning Bars

Model No.	Size	Fits Jack
440301	1/2" x 18"	SJ-5T
440302	5/8" x 24"	SJ-10T
440303	3/4" x 36"	SJ-15T to SJ-25T
440304	3/4" x 42"	SJ-15T to SJ-25T



440304



SJ-5T

## Michigan Pneumatic Model APGG1 Air Operated Grease Gun

One handed grease gun delivers 1500 to 9000 psi each time the trigger is pressed. Loads three ways and has E-Z air vent cap. Equipped with 1/4" NPT fitting.



## Michigan Pneumatic Model MC-114

### High Frequency Vibrator

For Molding/Core Machines and Foundries

Heavy-duty vibrator cast from ductile iron and precision machined to provide a long service life under the most adverse foundry conditions. Ideal for all production and automotive foundries. **Other models available.**



Length .....	5-3/4"
Height .....	3-1/4"
Width .....	2-3/8"
Mounting Bolt Centers .....	3-3/4" or 4"
Weight .....	7 lbs.
Vibrations/Min. @ 70 psi .....	9100
Air Inlet Thread .....	1/4"

## Chicago Pneumatic Model CP-718

### Car Shaker/Vibrator

Quickly locates all interior and exterior squeaks and rattles. Includes 28 ft. air supply and extension hose, frequency control regulator and 8 ft. exhaust hose with muffler.



Recommended Air Pressure .....	100-145 psi
Vibrations Per Minute .....	300-1400
Cylinder Weight .....	15 lbs.
Hose Size .....	3/8"
Average Air Consumption .....	3 cfm

# Air Line Accessories



## Michigan Pneumatic **Mini-Lube** Portable Lubricator

Model 100250 - 1/4" Air Flow 5-15 cfm



Weight ..... 2.5 oz.  
Length ..... 2-1/2"  
Maximum O.D. .... 1-3/16"  
Pipe Size ..... 1/4"  
Oil Capacity ..... 5 cc

## Michigan Pneumatic **Midget-Lube** Portable Lubricator

Model 300250 - 1/4" Air Flow 8-20 cfm  
Model 300375 - 3/8" Air Flow 10-30 cfm



Weight ..... 3.5 oz.  
Length ..... 2-1/2"  
Maximum O.D. .... 1-1/4"  
Pipe Sizes ..... 1/4" & 3/8"  
Oil Capacity ..... 9 cc

## Michigan Pneumatic **Master-Lube** Portable Lubricator

Model 400250 - 1/4" Air Flow 8-20 cfm  
Model 400375 - 3/8" Air Flow 10-40 cfm  
Model 400500 - 1/2" Air Flow 25-65 cfm



Weight ..... 5 oz.  
Length ..... 3-1/4"  
Maximum O.D. .... 1-5/8"  
Pipe Sizes ..... 1/4", 3/8" & 1/2"  
Oil Capacity ..... 22 cc

## Air Tool Inlet Regulators

Ideal for restricting the air flow to tools not equipped with built-in regulators. Model 894 CP style regulator features brass construction and a spring loaded ratchet, which prevents unintentional setting changes.

- Easy to install, easy to use.
- Provides precise regulation of air.

Model 894 1/4" NPT  
Model 5711 1/4" NPT  
Model 038-0.375 3/8" NPT  
Model 038-0.500 1/2" NPT



Model 894

## 1/4" Regulator

### with Pressure Gauge Model 5712-F

Ideal for restricting air flow to tools with 1/4" pipe thread. Features a built-in pressure gauge for perfect control of power. Handy, sturdy design and easy to attach.



## Regulator Pressure Gauge

- Quality air gauge designed for use with any air tool.
- Metal case with glass lens.



Model PG1 1/8" MPT, back mount, 0-160 psi, 1-1/2" dial  
Model PG2 1/4" MPT, back mount, 0-200 psi, 2" dial  
Model PG3 1/4" MPT, bottom mount, 0-160 psi, 2" dial

Other sizes and pressure ranges available.

## Air Line Pressure Gauge

- For constant reading of line pressure.
- 1/4" male bottom connection.
- Large indicator dial.
- Chrome plated case.



Model No.	Range	Dial Size
GB14100	0-100 psi	2"
GB14160	0-160 psi	
GB14200	0-200 psi	
GB14300	0-300 psi	
GB16160	0-160 psi	2-1/2"
GB16200	0-200 psi	
GB16300	0-300 psi	
GB17600	0-600 psi	3-1/2"

Other sizes and pressure ranges available.

## Safety Excess Flow Check Valve

- OSHA approved.
- Tamper proof construction.
- Allows full, unrestricted airflow.
- Automatically shuts off air flow in case of sudden air line break protecting personnel and property.
- Automatic reset after line repair.



Model No.	Inlet Size	Outlet Size
SV802	1/4" FPT	1/4" FPT
SV803	3/8" FPT	3/8" FPT
SV804	1/2" FPT	1/2" FPT
SV200F-85	2-1/4" FPT	2-1/4" FPT
SV806	3/4" MPT	3/4" FPT
SV808	1" MPT	1" FPT

## Full Flow Brass Ball Valve

For control of air, water and oil in hoses or pipelines up to 400 psi. Features a brass valve body, brass stems, stainless steel ball and die cast aluminum handle with a vinyl sleeve. Equipped with female threaded ends and full port design.

Model No.	Pipe Size
21104	1/4"
21106	3/8"
21108	1/2"
21112	3/4"
21116	1"
21120	1-1/4"





**Michigan Pneumatic**

**Miniature Assemblies - with Gauge**

MPT miniature assemblies include a filter, regulator, lubricator and gauge. Ideal where space is at a premium and a must for maximum protection of air operated equipment. **Filters feature a 5 micron sintered plastic element.**

- F50-1** 1/8" Filter
- F50-2** 1/4" Filter
- R55-1** 1/8" Regulator
- R55-1G** 1/8" Regulator & Gauge
- R55-2** 1/4" Regulator
- R55-2G** 1/4" Regulator & Gauge
- L50-1** 1/8" Lubricator
- L50-2** 1/4" Lubricator



**Model FRL-55-2**

Complete Assembly	Pipe Size	Capacity	Pressure
FRL-55-1	1/8"	1-1/2 oz.	0-100 psi
FRL-55-2	1/4"		

**Michigan Pneumatic**

**Complete Assemblies - with Gauge**

MPT trio assemblies include a filter, regulator, lubricator and gauge. An efficient, compact and permanent control assembly specially designed to provide maximum protection for air operated equipment, allowing tools to produce at peak operating efficiency. **\*High Capacity.**



**Model FRL-108W-4**

Model No.	Pipe Size
FRL-108W-2	1/4"
FRL-108W-3	3/8"
FRL-108W-4	1/2"
FRL-180-6*	3/4"
FRL-180-8*	1"

**Michigan Pneumatic**

**Regulators**

MPT regulators reduce high primary air pressure to a secondary air pressure of 0-200 psi. This simple, accurate pressure reduction device provides stable air pressure within a recommended range for maximum operating efficiency. Ideal for controlling the speed and power of air equipment. **To order with gauge, please specify "G" after the part number. \*High Capacity.**



**Model R100-4G**

Model No.	Pipe Size
R100-2	1/4"
R100-3	3/8"
R100-4	1/2"
R100-6	3/4"
R180M-8*	1"

**Michigan Pneumatic**

**Lubricators**

MPT lubricators automatically introduce an oil mist into the compressed air stream. Oil lubricates all precision working parts of air operated equipment, eliminating wear and allowing tools to produce at peak operating efficiency with a minimum of unscheduled downtime. Works with pipe scale, water and sludge in the bowl. **L28W features external oil adjustment. \*High Capacity.**



**Model L100-8**

Model No.	Pipe Size	Capacity
L28W-2	1/4"	1/2 pint
L28W-3	3/8"	1/2 pint
L28W-4	1/2"	1/2 pint
L100-6*	3/4"	1 pint
L100-8*	1"	1 pint

**Michigan Pneumatic**

**Filters**

MPT filters eliminate the dangers of corrosive damage to compressed air equipment by effectively removing pipeline impurities such as scale, dirt, rust and moisture from the air stream. Designed to prevent abrasive damage. Water is drained off through a petcock. Maximum working pressure 150 psi. **Features a 5 micron sintered plastic element. \*High Capacity.**



**Model F100-4**

Model No.	Pipe Size	Capacity
F100-2	1/4"	8 oz.
F100-3	3/8"	8 oz.
F100-4	1/2"	8 oz.
F100-6*	3/4"	16 oz.
F100-8*	1"	16 oz.

**Michigan Pneumatic**

**Filters - with Automatic Drain**

MPT airline filters with automatic drain automatically discharge water and contaminants from a filter for maximum protection of air operated equipment. Eliminates filter overflow. **Other sizes available up to 2". Features a 5 micron sintered plastic element. \*High Capacity.**



**Model FD100-4**

Model No.	Pipe Size	Capacity
FD100-2	1/4"	8 oz.
FD100-3	3/8"	8 oz.
FD100-4	1/2"	8 oz.
FD100-6*	3/4"	16 oz.
FD100-8*	1"	16 oz.

The above accessories will improve tool performance and increase tool life. For best results, mount accessories as close to the tool as possible. Made in the U.S.A.

# Air Line Lubricators



## Portable Air Line Lubricators

Designed to supply oil to air tools where it is not practical to use stationary lubricators. Can be installed as far away as 25 feet. Oil flows into the line each time the tool is started. Easy and inexpensive way to keep air tools operating at peak efficiency. Features adjustable oil flow, visible oil supply and rugged casting for use in severe conditions.

**In-line filters designed to screw directly into the lubricators available on page 155.**

**TX-02000PR** Pressure Relief Cap      **TXLRK** Repair Kit



**Model 0-R**  
Lubricator with optional pressure release cap

Model No.	Oil Capacity	Pipe Size	Rec'd Air Flow @70PSI	Max. PSI	Length	Height	Weight
0-R	1.4 oz.	1/2"	30 cfm	500	4-1/2"	2-1/4"	0.88 lbs.
1-R	3.7 oz.	3/4"	70 cfm	260	6"	2-3/4"	1.50 lbs.
2-R	11.0 oz.	3/4"	70 cfm	300	7"	3-1/2"	2.00 lbs.
2A-R	11.0 oz.	1"	70 cfm	300	7"	3-1/2"	2.00 lbs.
3-R	16.0 oz.	1"	150 cfm	250	10"	3-3/4"	4.25 lbs.

## In-line Lubricator w/ Integral Filter



**Model TX-1L-F**

Model No.	Oil Capacity	Pipe Size	Rec'd Air Flow @70PSI	Max. PSI	Height
TX-0L-F	1.4 oz.	1/2"	30 cfm	500	2-1/4"
TX-1L-F	3.7 oz.	3/4"	70 cfm	260	2-3/4"

## Safety Lock Cables

Helps prevent injury due to broken hose connections. Spring-powered loops provide a firm grip on the hose. **Bleed air pressure from hose before removing safety lock cable.**



**Model TX-SLC1**

Model No.	Cable Description (Dia. x L)	Fits Hose OD
TX-SLC1	1/8" x 20"	1/2" to 1-1/4"
TX-SLC2	1/4" x 38"	1-1/2" to 3"

## Lubricator Whip Hose Assemblies

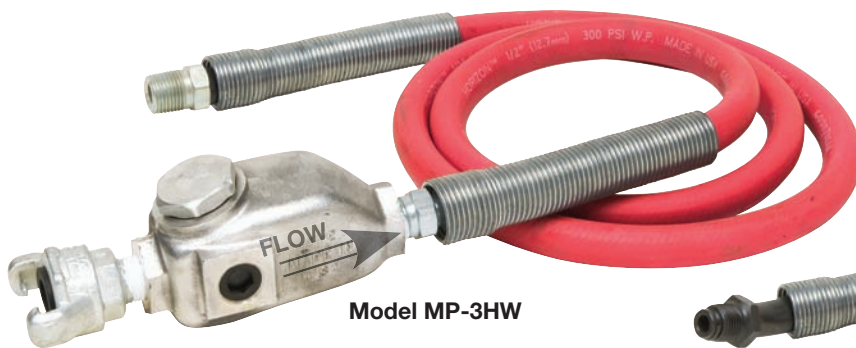

**Model MP-3HW**

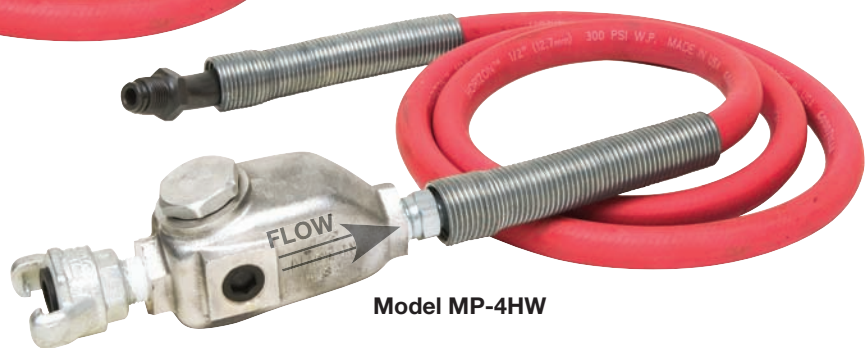

**Model MP-4HW**

**MADE U.S.A. IN THE**

Model No.	Assembly Components			Air Flow @ 70 psi
	Fitting to Tool	Hose	Lubricator	
MP-1HW	1/4" MPT	1/2" ID x 6 ft.	0-R	30 cfm
MP-2HW	3/8" MPT			
MP-3HW	1/2" MPT			
MP-4HW	L-1 swivel (7/8"-24 thread)			
MP-4HW-0.500	L-3 swivel (1/2" MPT)			

# Oil & Air Line Accessories



## Air Inlet Hose Swivels

For use on all chipping hammers and rivet busters. Designed to eliminate hose kinking or twisting for greater operator efficiency.

Model No.	Fitting to Tool	Hose Connection	Note
L-1 L-2 L-4	7/8"-24 thread	1/2" hose barb 3/8" MPT 3/8" FPT	Swivel Only
L-5 L-3 L-8	3/8" MPT 1/2" MPT 3/4" MPT	1/2" hose barb 1/2" hose barb 1/2" MPT	
L-1-Whip L-5-Whip L-3-Whip	7/8"-24 thread 3/8" MPT 1/2" MPT	1/2" hose barb	

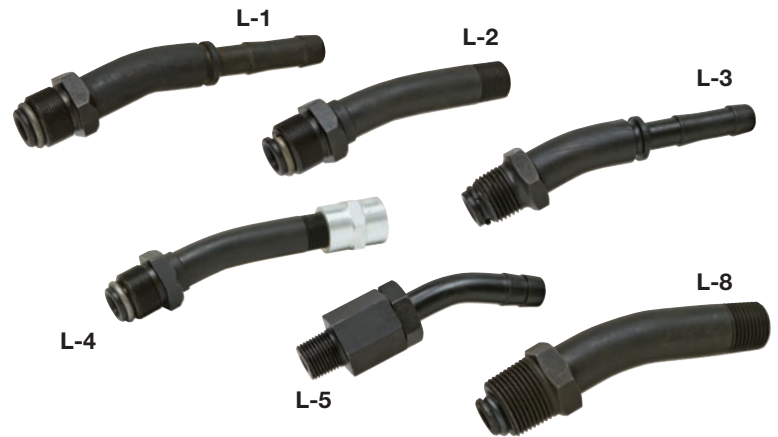

## 360° Swivels

Bi-directional 360° rotation universal joint keeps air hoses straight and untwisted. Increases the maneuverability of air tools and decreases operator fatigue.



- Model 922A** 1/4" NPT (Aluminum)
- Model 933A** 3/8" NPT (Aluminum)
- Model 933ST** 3/8" NPT (Steel)
- Model 944A** 1/2" NPT (Aluminum/Steel)

## Screened Inlet Bushings

Keeps rust and other air line debris from contaminating your tools. Manufactured from solid steel with brass screens pressed into the bushing.

MADE U.S.A. IN THE



Model No.	Description
1989	1/4" MPT x 1/4" FPT
1990	1/4" MPT x 3/8" FPT
1991	3/8" MPT x 1/4" FPT
1992	3/8" MPT x 3/8" FPT
1993	3/8" MPT x 1/2" FPT
1994	1/2" MPT x 3/8" FPT
1995	1/2" MPT x 1/2" FPT

## In-Line Air Filters

Protects air tools from rust, scale and dirt. Reduces expensive repairs and prolongs tool life. Designed for installation on air line at the point of use. Features a 40 micron sintered bronze filter element.



Model 9074

Model No.	Inlet Size	Outlet Size	Length
9072	1/4" FPT	1/4" MPT	2-5/16"
9073	3/8" FPT	3/8" MPT	2-5/16"
9074M	1/2" FPT	1/2" MPT	3-1/4"
9076M	3/4" FPT	3/4" MPT	3-1/4"
9074	1/2" FPT	1/2" FPT	3-1/4"
9076	3/4" FPT	3/4" FPT	3-1/4"

## In-line Manifolds

- Supply up to 6 air hoses from one station, using up to 6 different style couplers
- Mount to workbench or wall
- Permits use of air by more than one mechanic

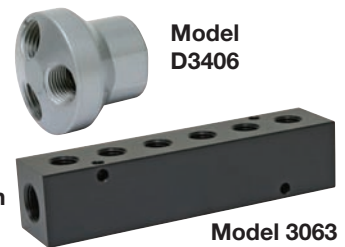

Model No.	Inlet Size	Outlet Size	No. of Ports
D3404 D3406 D3408	1/4" 3/8" 1/2"	1/4"	3
3043 3063	3/8"	1/4"	4 6

## Marvel

### Air Tool Oil

A specially formulated high grade lubricating oil for all piston and rotary-type air tools. Lubricates and rust proofs for longer tool life.

- OIL-080** 4 Ounce
- OIL-085** 1 Quart



### Winter Grade Oil with De-Icing Additive

Designed for extreme weather conditions down to -45° F. Eliminates freezing while lubricating tools. Can be used in conventional air line lubricators or applied directly into the tools air inlet.

- Convenient "flip up" pour top (4 oz. and pint bottles only)

- ATL004W** 4 Ounce
- ATL016W** 1 Pint
- ATL128W** 1 Gallon



# Manifolds



Michigan Pneumatic

## Air Manifolds

Keep the work site uncluttered by using only one hose to power up to eight tools at once. Equipped with a gauge to monitor working pressure and a 200 psi pop-off valve to prevent excessive pressure build-up. Easily bolts to skids or other surfaces and multiple manifolds can be used in tandem.

AM23 1-1/2" 4-Lug Universal Coupling

**A.S.M.E. Certified**  
Meets OSHA Requirements

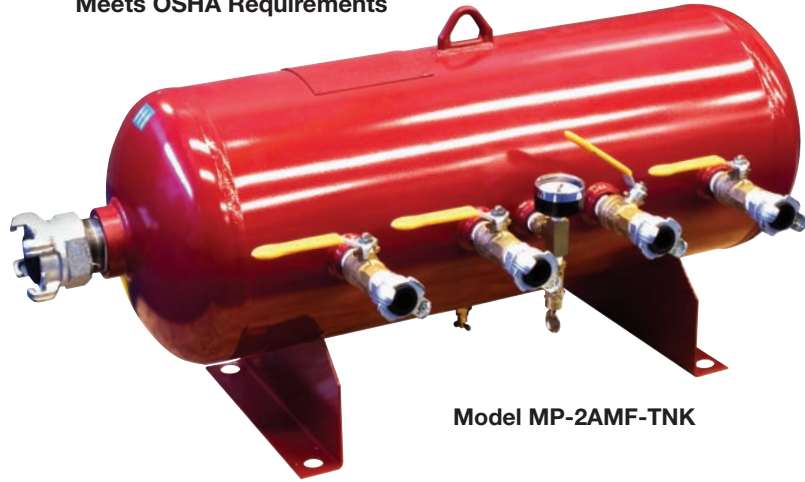

Model MP-2AMF-TNK



MADE  
**U.S.A.**  
IN THE



Model MP-3AMF-TNK

Model No.	Number of Outlets	Capacity (Gallons)	Working Pressure	Inlet Size	Tank Diameter	Width w/Fittings	Height	Length	Weight
MP-3AMF-TNK	4	2.5	200 psi	1"	8"	18.5"	10"	23.0"	23 lbs.
MP-2AMF-TNK	8	15.0		2"	12"	22.0"	18"	34.5"	63 lbs.

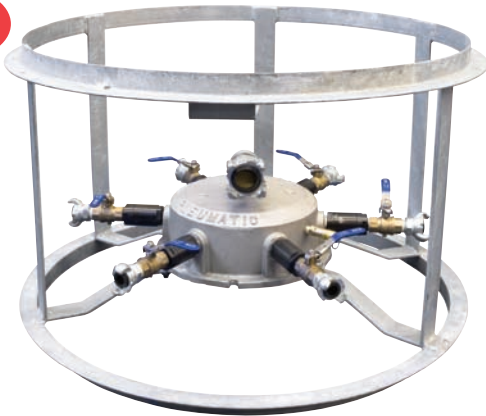

### Michigan Pneumatic Model MP-1AMF Radial Air Manifold

Used in any industry with a need for multiple outlets of air to supply various pneumatic tools simultaneously. **The 1-1/2" inlet can be dispersed through up to six separate outlets using 3/4" CP couplings.** Each outlet is regulated by a bronze safety lock ball valve. Features a pressure relief valve for protection against excessive pressure and filters for clean air.

AM23 1-1/2" 4-Lug Universal Coupling

MADE  
**U.S.A.**  
IN THE

Diameter .....	36"
Height.....	15"
Weight.....	102 lbs.
Air Inlet.....	1-1/2"



### Michigan Pneumatic Model MP-6-PAK Radial Air Manifold - with Moisture Separator

Used in any industry with a need for multiple air outlets to supply various pneumatic tools simultaneously. **The 1-1/2" inlet can be dispersed through up to six separate outlets using 3/4" CP couplings.** Each has a manual shut-off valve and moisture separator with auto drain valve, increasing tool life. Rugged steel tubular design, with tabs, can be rolled to the job site and allows unit to be lifted and stacked.

AM23 1-1/2" 4-Lug Universal Coupling

Diameter .....	36"
Height.....	18"
Weight.....	175 lbs.
Air Inlet.....	1-1/2"



## Self-Storing Coiled Nylon Air Hose

- Rugged construction
- Extends and retracts like a telephone cord
- Improves safety and efficiency
- Saves space
- Oil and abrasion resistant
- Lightweight
- 200 psi working pressure
- Reusable male fittings

Features 360° Swivel Fittings.



### 1/4" Coiled Hose

Model No.	Length	Storage Length
N14-12B	12 ft.	5"
N14-25B	25 ft.	10"
N14-50B	50 ft.	20"

### 3/8" Coiled Hose

Model No.	Length	Storage Length
N38-12B	12 ft.	5"
N38-25B	25 ft.	10"
N38-50B	50 ft.	20"

### 1/2" Coiled Hose

Model No.	Length	Storage Length
N12-12B	12 ft.	5"
N12-25B	25 ft.	10"
N12-50B	50 ft.	20"

## Industrial Grade Air Hose - with Fittings

- Maximum pressure 200 psi to 250 psi
- Heavy-duty double strand
- High tensile rayon cord
- Braided body
- Tough neoprene
- Oil resistant



## Industrial Whip Hose - with Fittings

- Maximum pressure 200 psi to 250 psi
- Oil resistant



Model	Hose ID	Hose OD	Length	Max.PSI	Fittings
WH-2	1/4"	1/2"	10 ft.	200 psi	1/4" MPT
WH-4	3/8"	11/16"		200 psi	1/4" MPT
WH-6	1/2"	1-3/16"		250 psi	1/2" MPT
WH-7	1/2"	1-3/16"	10 ft.	250 psi	1/4" MPT x CP
WH-8					3/8" MPT x CP
WH-9					1/2" MPT x CP
WH-10					1/2" MPT x 3/8" MPT
WH-11	1/2"	1-3/16"	10 ft.	250 psi	1/2" MPT x L-1
WH-12					1/2" MPT x L-3
WH-13					3/4" MPT x L-1
WH-14					3/4" MPT x L-3

Model	Hose ID	Hose OD	Length	Max.PSI	Fittings
AH-1	1/4"	1/2"	25 ft.	200 psi	1/4" MPT
AH-2	1/4"	1/2"	50 ft.		
AH-3	3/8"	11/16"	25 ft.		
AH-4	3/8"	11/16"	50 ft.		
AH-44	1/2"	1-3/16"	25 ft.	250 psi	1/2" MPT
AH-45	1/2"	1-3/16"	50 ft.		1/2" MPT
AH-5	3/4"	1-5/32"	50 ft.		Chicago Fitting
AH-6	1"	1-7/16"	50 ft.		Chicago Fitting

Other sizes also available. All air hoses are industrial grade construction.

## Neoprene Swivel Pigtail Assemblies with Female Fitting and Male Swivel



Model No.	Hose Size ID	Length	Fittings
RP0418S	1/4"	18"	1/4" NPT
RP0436S		36"	
RP0618S	3/8"	18"	3/8" NPT
RP0624S		24"	
RP0636S		36"	

## Stainless Worm Gear Hose Clamps



Model No.	Minimum Diameter	Maximum Diameter
HS6	7/16"	25/32"
HS8	1/2"	29/32"
HS10	9/16"	1-1/16"
HS12	11/16"	1-1/4"
HS16	13/16"	1-1/2"
HS20	13/16"	1-3/4"
HS24	1-1/16"	2"
HS28	1-5/16"	2-1/4"
HS32	1-9/16"	2-1/2"

## K-Series Band Clamps & Tools

Model	ID
K3-CLAMP	13/16"
K311-CLAMP	1-3/8"
K4-CLAMP	1"
K5-CLAMP	1-1/4"
K6-CLAMP	1-1/2"
K7-CLAMP	1-3/4"
K8-CLAMP	2"
K9-CLAMP	2-1/4"
K10-CLAMP	2-1/2"
K11-CLAMP	2-3/4"
K12-CLAMP	3"

K-Series Band Clamp

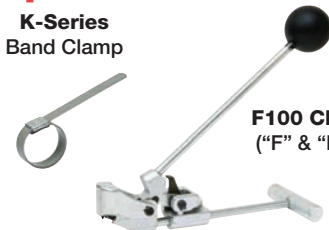

F100 Clamp Tool ("F" & "K" Series)

F38 Clamp Tool (not shown) (F-Series clamps only)

F-Series center punch clamps also available.



## Proper Selection Guidelines

**1/4" Series:** Recommended for tools requiring up to 25 cfm of air, such as small drills, screwdrivers and air hammers using a 1/4" and 3/8" air hose.

**3/8" Series:** Recommended for tools requiring up to 50 cfm of air, such as drills up to 1/2", impact wrenches 3/8" to 5/8", and die grinders and chipping hammers using a 3/8" hose.

**1/2" Series:** Recommended for tools requiring up to 90 cfm of air, such as drills up to 1-1/4", impact wrenches 3/4" to 1-1/4", grinders 4" to 8", and heavy chipping and riveting hammers using a 1/2" hose.

Foster industrial couplers feature the standard industrial interchange design most widely used in industry. Please specify the same series size couplers and plugs when ordering. Plugs of one series size will not fit couplers of another size. **Other types and styles of couplers and connectors are available.**

### Quick Change Couplers

with Male Pipe Thread

Model No.	Series	Thread Size
2903	1/4"	1/8" MPT
3103	1/4"	1/4" MPT
3303	1/4"	3/8" MPT
4104	3/8"	1/4" MPT
4304	3/8"	3/8" MPT
4504	3/8"	1/2" MPT
5105	1/2"	3/8" MPT
5305	1/2"	1/2" MPT
5505	1/2"	3/4" MPT



### Quick Change Couplers

with Female Pipe Thread

Model No.	Series	Thread Size
2803	1/4"	1/8" FPT
3003	1/4"	1/4" FPT
3203	1/4"	3/8" FPT
4004	3/8"	1/4" FPT
4204	3/8"	3/8" FPT
4404	3/8"	1/2" FPT
5005	1/2"	3/8" FPT
5205	1/2"	1/2" FPT
5405	1/2"	3/4" FPT



### Quick Change Plugs

with Male Pipe Thread

Model No.	Series	Thread Size
12-3	1/4"	1/8" MPT
10-3	1/4"	1/4" MPT
14-3	1/4"	3/8" MPT
40-4	3/8"	1/4" MPT
42-4	3/8"	3/8" MPT
44-4	3/8"	1/2" MPT
52-5	1/2"	3/8" MPT
54-5	1/2"	1/2" MPT
56-5	1/2"	3/4" MPT



### Quick Change Plugs

with Female Pipe Thread

Model No.	Series	Thread Size
13-3	1/4"	1/8" FPT
11-3	1/4"	1/4" FPT
15-3	1/4"	3/8" FPT
41-4	3/8"	1/4" FPT
43-4	3/8"	3/8" FPT
45-4	3/8"	1/2" FPT
53-5	1/2"	3/8" FPT
55-5	1/2"	1/2" FPT
57-5	1/2"	3/4" FPT



### Quick Change Couplers

with Hose Stem

Model No.	Series	Hose I.D.
3603	1/4"	1/4"
3703	1/4"	3/8"
4604	3/8"	1/4"
4804	3/8"	3/8"
4904	3/8"	1/2"
5705	1/2"	3/8"
5805	1/2"	1/2"
5905	1/2"	3/4"



### Quick Change Couplers

with Hose Stem

Model No.	Series	Hose I.D.
16-3	1/4"	1/4"
17-3	1/4"	3/8"
46-4	3/8"	1/4"
48-4	3/8"	3/8"
49-4	3/8"	1/2"
59-5	1/2"	3/8"
60-5	1/2"	1/2"
61-5	1/2"	3/4"



### Barbed Hose Stems

Brass

Model No.	Thread Size	Hose I.D.
M-3	1/8" MPT	1/4"
M-4	1/8" MPT	5/16"
M-5	1/8" MPT	3/8"
M-6	1/4" MPT	3/16"
M-7	1/4" MPT	1/4"
M-8	1/4" MPT	5/16"
M-9	1/4" MPT	3/8"
M-11	1/4" MPT	1/2"
M-12	3/8" MPT	1/4"
M-13	3/8" MPT	3/8"
M-14	3/8" MPT	1/2"
M-15	3/8" MPT	3/4"
M-16	1/2" MPT	3/8"
M-17	1/2" MPT	1/2"
M-19	1/2" MPT	3/4"



### Barbed Hose Stems

Steel

Model No.	Thread Size	Hose I.D.
3501	1/8" MPT	1/4"
3502	1/4" MPT	1/4"
3503	1/8" MPT	3/8"
3504	3/8" MPT	1/4"
3505	1/4" MPT	3/8"
3506	3/8" MPT	3/8"
3508	1/2" MPT	3/8"
3509	1/4" MPT	1/2"
3510	3/8" MPT	1/2"
3511	3/4" MPT	1/2"
3512	1/2" MPT	1/2"
3513	1/2" MPT	3/4"
3514	3/4" MPT	3/4"
3518	1" MPT	1"



Can be used in conjunction with Dixon universal coupling hose clamps.





# Air Hose Couplings & Fittings

## Universal Couplings

Male Thread

Model No.	Male Thread
UM-25-M	1/4"
UM-37-M	3/8"
UM-50-M	1/2"
UM-75-M	3/4"
UM-100-M	1"



## Universal Couplings

Female Thread

Model No.	Female Thread
UF-25-M	1/4"
UF-37-M	3/8"
UF-50-M	1/2"
UF-75-M	3/4"
UF-100-M	1"



## Universal Couplings

Hose End

Model No.	Hose I.D.
UH-37-M	3/8"
UH-50-M	1/2"
UH-62-M	5/8"
UH-75-M	3/4"
UH-100-M	1"



## Universal Coupling Accessories



**AC1**  
Safety Lock Clip



**AWR-4**  
Rubber Gasket for  
Universal Coupling



**UD-301-M**  
Universal "Dead-End"  
Coupling



**UW-300-M**  
Universal 3-Way  
Coupling

## Universal Coupling

Hose Clamps

Model No.	Hose I.D.	For Hose O.D.
CD	3/8"	11/16" to 7/8"
B5	1/2"	1-1/16" to 1-3/16"
BU9	3/4"	1-3/16" to 1-5/16"
A-10	7/8"	1-5/16" to 1-1/2"
B14	1"	1-21/32" to 1-15/16"



## Double Bolt Hose Clamps

Model No.	Hose I.D.	Fits Hose O.D.
SL29	1/2"	7/8" to 1-1/8"
J48	3/4"	1-1/8" to 1-3/16"
JX49	1"	1-7/16" to 1-17/32"
DL14	1-1/4"	1-5/8" to 1-13/16"
DL20	1-1/2"	1-3/4" to 2-3/64"



## Barbed Hose Stems

Steel



Model No.	Hose O.D.
DMA	1/4" x 1/4"
DMB	3/8" x 3/8"
DM1	1/2" x 1/2"
DM6	3/4" x 3/4"
DM11	1" x 1"

## Swivel Barbed Hose Stems

Brass



Model No.	MPT	Hose I.D.
M7S	1/4"	1/4"
M13S	3/8"	3/8"
M17S	1/2"	1/2"

## Swivel Fittings

Brass



Model No.	MPT	FPT
25US	1/4"	1/4"
38US	3/8"	3/8"

## Couplings

Brass



Model No.	FPT
PF2072	1/8"
PF2074	1/4"
PF2076	3/8"
PF2078	1/2"
PF2079	3/4"
PF2080	1"
PF20842	1/4" x 1/8"
PF20862	3/8" x 1/8"
PF20864	3/8" x 1/4"
PF20884	1/2" x 1/4"
PF20886	1/2" x 3/8"

## Adapters

Brass



Model No.	MPT	FPT
H0202	1/8"	1/8"
H0402	1/4"	1/8"
H0404	1/4"	1/4"
H0604	3/8"	1/4"
H0606	3/8"	3/8"
H0806	1/2"	3/8"
H0808	1/2"	1/2"
H0809	3/4"	3/4"
H0810	1"	1"

## Reducer Bushing

Brass



Model No.	MPT	FPT
PF20942	1/4"	1/8"
PF20962	3/8"	1/8"
PF20964	3/8"	1/4"
PF20982	1/2"	1/8"
PF20984	1/2"	1/4"
PF20986	1/2"	3/8"
PF209124	3/4"	1/4"
PF209126	3/4"	3/8"
PF209128	3/4"	1/2"
PF209168	1"	1/2"
B21612	1"	3/4"

## Hex Nipples

Brass



Model No.	MPT	FPT
PF22222	1/8"	1/8"
PF22242	1/8"	1/4"
PF22244	1/4"	1/4"
PF22264	1/4"	3/8"
PF22266	3/8"	3/8"
PF22286	3/8"	1/2"
PF22288	1/2"	1/2"



## Nippon Pneumatic Model JAC-2

### Vacuum Air Cleaner



Inexpensive, efficient tool for cleaning auto interiors. Ideal for repair shops and foundries for vacuuming scrap and dust instead of blowing off.

- Compact and lightweight
- Tremendous vacuuming power
- Venturi Style



## Michigan Pneumatic Model BLS

### Safety Air Blow Gun

The first air duster ever made with a conical air curtain system to protect workers from injury. **OSHA approved.**



- 1/4" male inlet
- Eliminates blowing metal chips
- Adjustable air curtain angle
- Designed for safety and efficiency

## Michigan Pneumatic Model 336-RT

### Rubber-Tip Blow Gun



- Handy hang-up hook
- Rugged construction
- 1/4" female inlet
- Ideal for use on delicate surfaces
- Extension blow guns available

### Safety Brush Blow Gun

Exclusive 2-in-1 safety brush blow gun features a standard blow gun with a choice of built-in wire, nylon or horsehair brushes for fast, easy air-blast cleaning. **Blow brush conforms to OSHA standards. Replacement brushes available.**



- Model 801S** Safety blow gun with steel brush
- Model 802S** Safety blow gun with nylon brush
- Model 803S** Safety blow gun with horsehair brush
- Model 810K** Safety blow gun kit with all 3 brushes: steel, nylon and horsehair

## Blow/Vacuum Gun

A two-in-one cleaning gun for high powered vacuum cleaning or precise, high-velocity air pressure cleaning of machine tools. Also useful for cooling industrial and manufacturing processes. **Deep hole gun kit available.**

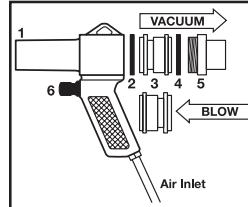

1. Body
2. O-Ring
3. Venturi
4. O-Ring
5. End Section
6. Trigger Assembly

Vacuum .....	4"
Air Pressure .....	101.5 psi
Air Consumption:.....	17.65 cfm
Air Output.....	123.65 cfm

### Model:

- BV11-DBK** Gun with dust bag kit
- BV22-DBK** Gun with dust bag kit
- BV11** 11mm Blow/Vacuum gun without dust bag kit
- BV22** 22mm Blow/Vacuum gun without dust bag kit

## Positive Grip Air Chuck Model CHAP-4400

1/4" I.D. x 12" hose with brass ball chuck and 1/4" female swivel fittings. Ideal for up to 250 psi.



## Tire Inflation Gauge Model TGC-090

Rugged, compact, lightweight and sturdy. Designed for cars and trucks. Features aluminum casting and solid brass dial calibrated from 10-90 psi in 2 lb. increments.



## Safety Air Blow Gun Model F5048AA

Lightweight, heavy-duty aluminum extension provides longer reach for cleaning hard-to-reach areas. Delivers full power from the air compressor. Side ports draw ambient air inward, intensifying the volume of air power at the tip. **Meets OSHA safety standards.**

- Dead-man trigger
- Adjustable auxiliary handle

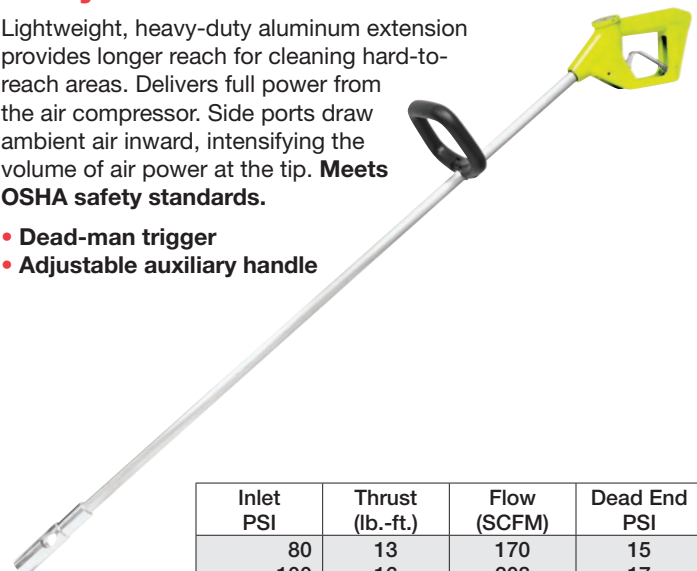

Inlet PSI	Thrust (lb.-ft.)	Flow (SCFM)	Dead End PSI
80	13	170	15
100	16	208	17
120	18	244	21
(max.) 150	24	302	29

# Air Movers/Ventilators



Michigan Pneumatic

## Venturi Style Air Movers

Michigan Pneumatic venturi style air movers are used in many industrial and construction sites where there is a need to disperse hazardous fumes, move air into a confined space, cool individuals in elevated temperature conditions, or ventilate equipment and machinery with a blast of directed air. Common applications include shipyards, refineries, chemical plants, paper mills and manhole ventilation.

- No moving parts
- Minimal required maintenance
- Can be used as a blower or for exhaust
- Safe in hazardous areas
- Performance tested
- Lightweight and portable

**MADE  
U.S.A.  
IN THE**



MP-3AMS

MP-6AM

MP-10AM

Michigan Pneumatic Model JF20

## Jet Fan

Features a heavy-duty, hi-tech, four blade design that is versatile for a wide range of applications. Can be used either as a blower or an exhauster, and is well suited for confined areas for the removal of hazardous fumes or contaminated air from applications such as welding or sand blasting.

- Six turbulence-eliminating guide vanes
- Operates at lower RPMs while moving more air
- Heat treated to T6 aircraft aluminum specifications
- Stainless steel fan guard meets OSHA standards
- Use for general ventilation

**MADE  
U.S.A.  
IN THE**



JF20

Model No.	Overall Length	Base Diameter	Top of Horn Diameter	Bolt Circle Diameter	Base Slot Diameter	Weight	Air Inlet Thread
MP-3AMS	16.75"	7.31"	6.00"	6.56"	0.4"	6.2 lbs.	1/2"
MP-3AM	30.50"	7.31"	7.00"	6.56"	0.4"	9.2 lbs.	1/2"
MP-6AM	44.25"	11.25"	12.50"	10.50"	0.4"	23.2 lbs.	1"
MP-8AM	46.06"	14.37"	14.25"	13.62"	0.5"	35.2 lbs.	1"
MP-10AM	48.00"	17.00"	15.75"	15.50"	1.0"	41.6 lbs.	1"
JF20	12.50"	27.00"	-	* 20.00"	1.0"	95.0 lbs.	3/4"

\* Matches American Petroleum Institute tank opening

### Inlet Pressure - Total Air Flow

Model No.	40 psig	60 psig	80 psig	100 psig
MP-3AMS	815 cfm	981 cfm	1182 cfm	
MP-3AM	1017 cfm	1231 cfm	1462 cfm	
MP-6AM	2385 cfm	2885 cfm	3347 cfm	-
MP-8AM	3152 cfm	4152 cfm	4929 cfm	
MP-10AM	4898 cfm	6182 cfm	7304 cfm	
JF20	5920 cfm	7600 cfm	9100 cfm	10420 cfm

### Inlet Pressure - Air Consumption

Model No.	40 psig	60 psig	80 psig	100 psig
MP-3AMS	36 scfm	50 scfm	62 scfm	
MP-3AM	35 scfm	45 scfm	62 scfm	
MP-6AM	73 scfm	98 scfm	124 scfm	-
MP-8AM	114 scfm	152 scfm	193 scfm	
MP-10AM	154 scfm	209 scfm	274 scfm	
JF20	60 scfm	114 scfm	186 scfm	292 scfm

Pneumatic air movers have been tested at an independent laboratory. The free flow ratings listed above are based on tests to AMCA Standard 210. Under identical testing situations, pneumatic air movers equalled or exceeded the air flow of competitively manufactured air movers.

## A

**Aircraft Accessories** ..... 33, 102-104  
**Air Hammers - Automotive** 98-99, 104  
**Air Hoists** ..... 138  
**Air Hose** ..... 154, 157  
**Air Line Accessories** ..... 152-160  
**Air Marking Pen** ..... 91  
**Air Movers** ..... 161  
**Air Nippers** ..... 76

## B

**Balancers** ..... 148-149  
**Beam Clamps** ..... 144  
**Bench Grinders** ..... 73  
**Bevelers** ..... 82  
**Blow Guns** ..... 160

## C

**C-Clamps** ..... 150  
**Car Shaker** ..... 151  
**Caulking Gun** ..... 151  
**Chain Hoists**  
 Air..... 138  
 Hand ..... 139-141  
 Lever ..... 142-143  
**Chain Pullers** ..... 142-143  
**Chipping Hammers** ..... 109-111, 114  
 Accessories ..... 112-114, 155  
**Chisels**  
 Chipping Hammer..... 112  
 Clay Digger ..... 132-133  
 Panel Cutter ..... 102  
 Pavement Breaker ..... 132-133  
 Rivet Buster ..... 108  
 Riveter..... 102-103, 108  
 Weldflux Scaler ..... 119  
 Zip Gun ..... 102-103  
**Chucks** ..... 24, 38-39, 42  
**Clamps** ..... 144, 150, 157, 159  
**Clay Diggers** ..... 129  
 Accessories ..... 129, 132-133, 155  
**Collets & Collet Inserts** ..... 59-61  
**Compression Riveters** ..... 92-93  
**Concrete Vibrators** ..... 135  
**Confined Space Ventilators** ..... 161  
**Connectors** ..... 137, 158-159  
**Construction Equip.** .... 105-108, 124-137  
**Core Knock-Out Tool** ..... 114  
**Couplers** ..... 137, 158-159  
**Cut-Off, Utility** ..... 74  
**Cutting Tools** ..... 43, 74-85

## D

**Die Grinders** ..... 53-58  
 Accessories ..... 59-61  
**Drill Chucks** ..... 24, 38-39, 42  
**Drills**  
 Accessories ... 33, 38-39, 42, 134-137  
 1/4"-1/2" ..... 30-32, 34-35  
 9/16"-3" ..... 36-37, 39-41, 43  
 Angle..... 30, 32  
 Corner..... 41  
 Heavy-Duty ..... 32, 34-37, 40-41  
 Magnetic ..... 43  
 Non-Reversible ..... 30-32, 34-35, 41  
 Reversible ..... 30-31, 34-37, 40  
 Rock..... 136  
 Wood Borer..... 36-37, 40

## E

**Electric Tools** ..... 75, 79-84  
**Engraving Tools** ..... 91

## F

**Filing Tools** ..... 52, 77  
**Filters** ..... 153  
**Fittings** ..... 155, 158-159  
**Foot Control Pedal** ..... 95-96

## G

**Gauges** ..... 152-153  
**Grease Guns** ..... 151  
**Grinders**  
 Accessories ..... 59-61, 72-73  
 Angle..... 54-55, 66-69  
 Belt..... 63-64  
 Bench..... 73  
 Cone ..... 63-64  
 Cup Wheel ..... 68-71  
 Die..... 53-58  
 Electric ..... 73, 75  
 Extended Die ..... 54-55, 58, 62  
 Pencil, High-Speed..... 53  
 Port-A-Belt..... 63-64  
 Small Wheel ..... 62-64  
 Straight ..... 62-65  
 Vertical ..... 70-71  
 Water Feed ..... 68-69  
**Grinding Wheels** ..... 72-73

## H

**Hammers**  
 Accessories ..... 101-105, 112-114  
 119, 120, 134-135, 155  
 Automotive..... 99, 104  
 Chipping ..... 109-111, 114  
 Clay Diggers ..... 129  
 Nail Driving Attachment..... 101, 105  
 One-Shot ..... 98  
 Palm..... 98  
 Paving ..... 130-131  
 Riveting ..... 105  
 Roto ..... 134  
 Scaling ..... 115-118, 120, 122-123  
**Hoists**  
 Air..... 138  
 Hand Chain..... 139-141  
 Lever ..... 142-143  
 Tugger ..... 146-147  
**Hose, Air** ..... 154, 157  
**Hose Swivel** ..... 155  
**Hose Reels** ..... 149  
**Hydraulic Jacks** ..... 145  
**Hydraulic Pump** ..... 88

## I

**Impact Wrenches**  
 Accessories ..... 22-25  
 Angle..... 5, 13  
 Automotive..... 4-8  
 Heavy-Duty ..... 6, 8, 10, 14-15  
 Industrial ..... 9-21  
 Pistol ..... 4-10, 15, 20-21  
 Pulse/Pulsus ..... 17-21  
 Ratchet ..... 4  
 Straight ..... 4, 6, 9-14, 21  
 Torque Controlled ..... 21

## J

**Jacks**  
 Toe & Screw ..... 151  
 Hydraulic..... 145

## L

**Lubricators** ..... 152-154

## M

**Manifold** ..... 156  
**Marking Pen** ..... 91  
**Metal Shears** ..... 80-81, 83

## N

**Needle Scalars** ..... 115-117, 120-121  
**Nibblers**  
 Air..... 82, 85  
 Electric..... 82, 84  
**Nippers** ..... 76  
 Accessories ..... 76  
**Nutrunners** ..... 39

## O

**Oil** ..... 155

## P

**Paint Guns** ..... 91  
**Pavement Breakers** ..... 130-131  
 Accessories ..... 132-133  
**Planishing Hammer Accessories** . 104  
**Polishers** ..... 47-48  
**POP® Riveters** ..... 86-87, 89  
**Pullers** ..... 142-143  
**Pulse/Pulsus Tools** ..... 17-21  
**Punch/Flange Tools** ..... 91

## R

**Rammers** ..... 124-127  
 Accessories ..... 128  
**Ratchet Wrenches** ..... 4  
**Regulators** ..... 152-153  
**Retainers**  
 Chipper ..... 113-114  
 Rivet Buster ..... 108  
 Riveter..... 102-103, 105  
**Riveter Pump** ..... 88  
**Riveters**  
 Accessories..... 88-89, 94-97,  
 101-103, 105, 155  
 Aircraft ..... 100-101, 104  
 Automotive..... 98-99, 104  
 Blind..... 86-90  
 Chisels ..... 102-103  
 Compression..... 92-93  
 Hand ..... 89  
 Heavy-Duty ..... 105  
 Nail Driving Attachment ..... 101, 105  
 One-Shot ..... 98  
 POP® ..... 86-89  
 Rivet Busters ..... 105-107  
 Rivet Sets..... 97, 103, 105  
 Riv-Nut/Rivet-Nut ..... 88, 90  
 Squeezer Accessories ..... 88, 94-97  
 Yoke ..... 92-93  
**Rivet Busters** ..... 105-107

Accessories ..... 105, 108, 155  
**Rivet Sets** ..... 97, 103, 105  
**Rock Drills** ..... 134, 136  
 Accessories ..... 134-137  
**Roto Hammers** ..... 134  
 Accessories ..... 134-135  
**Routers** ..... 57

## S

**Sanders**  
 Accessories ..... 63, 72-73  
 Angle..... 44, 68-69  
 Belt..... 49-50, 63-64  
 Disc..... 44  
 Dual Action ..... 45-46  
 Jitterbug..... 51  
 Orbital ..... 45-47, 50-51  
 Orbital w/Vacuum ..... 45-47  
 Palm..... 46, 50-52  
 Right Angle ..... 44, 68-69  
 Straight ..... 52  
 Vacuum Assisted ..... 45-47  
 Vertical ..... 48  
 Water Feed ..... 69  
**Sand Rammers** ..... 124-127  
 Accessories ..... 128  
**Saws**  
 Accessories ..... 77-78  
 Band ..... 79  
 Chain..... 79  
 Circular..... 74-75  
 Concrete ..... 79  
 Panel..... 74-75  
 Reciprocating..... 77-78  
 Rotary ..... 74-75

**Scaling Hammers**  
 Accessories ..... 112-113, 119  
 Concrete ..... 122-123  
 Long Reach..... 118  
 Needle..... 115-117, 120-121  
 Piston..... 122-123  
 Triplex ..... 122-123  
 Weldflux ..... 115-118, 120

**Scissor Shears** ..... 80-81, 83  
**Screwdrivers** ..... 4, 18-20, 26-29  
 Accessories ..... 24-25

**Scribe** ..... 91  
**Shears**  
 Air..... 80-81, 83  
 Electric ..... 80-81, 83

**Sockets, Impact** ..... 22-24  
**Spray Guns** ..... 91

**Springs, Retainer**  
 Chipper ..... 113-114  
 Rivet Buster ..... 108  
 Riveter..... 102-103

**Squeezers, Rivet** ..... 92-93  
 Accessories ..... 88, 94-97  
**Stone Tool** ..... 99  
**Swivels** ..... 155, 158-159

## T

**Tampers** ..... 126-127  
**Tappers** ..... 35  
**Tire Gauge** ..... 160  
**Tool Balancers** ..... 148-149  
**Torque Controlled, Impacts** ..... 21  
**Trimmers** ..... 74, 76  
**Trolleys** ..... 144  
**Tuggers** ..... 146-147

## U

**Universal Couplings** ..... 159  
**Utility Cut-Off** ..... 74

## V

**Vacuums, Air Cleaner** ..... 160  
**Ventilators/Air Movers** ..... 161  
**Vertical Grinders** ..... 70-71  
**Vertical Sanders** ..... 48  
**Vibrators** ..... 135, 151  
**Vises** ..... 151

## W

**Weldflux Scalars** ..... 115-118, 120  
**Winches** ..... 146-147  
**Wire Brush/Wheel** ..... 72  
**Wire Trimmers** ..... 76  
**Wood Borers** ..... 36-37, 40

## Z

**Zip Guns** ..... 99-101

As a valuable link in your supply chain, **Michigan Pneumatic** maintains an enormous warehouse inventory.

If you are unable to find the items you require, please call our Customer Service Staff:

**1-800-521-8104**

# Conversion Tables



In.-Lbs. x 0.113 = Newton Meters (Nm)

Nm x 8.849 = In.-Lbs.

Ft. -Lbs. x 1.356 = Nm

Nm x 0.737 = Ft.-Lbs.

## Torque Conversion

### Ft.-Lbs. to Newton Meters (Nm)

Ft.-Lbs.	Nm	Ft.-Lbs.	Nm
1	1.356	64	86.8
2	2.7	65	88.1
3	4.1	66	90.0
4	5.4	67	90.9
5	6.8	68	92.2
6	8.1	69	93.6
7	9.5	70	94.9
8	10.9	71	96.3
9	12.2	72	97.6
10	13.6	73	99.0
11	14.9	74	100.3
12	16.3	75	102.0
13	17.6	76	103.1
14	19.0	77	104.4
15	20.3	78	105.8
16	21.7	79	107.1
17	23.1	80	108.5
18	24.4	81	110.0
19	25.8	82	111.2
20	27.1	83	112.6
21	28.5	84	114.0
22	29.8	85	115.3
23	31.2	86	117.0
24	32.5	87	118.0
25	33.9	88	119.3
26	35.3	89	121.0
27	36.6	90	122.0
28	38.0	91	123.4
29	39.3	92	125.0
30	40.7	93	126.1
31	42.0	94	127.5
32	43.4	95	129.0
33	44.8	96	130.2
34	46.1	97	131.5
35	47.5	98	133.0
36	48.8	99	134.2
37	50.2	100	135.6
38	52.0	110	149.2
39	52.9	115	156.0
40	54.2	120	163.0
41	55.6	125	170.0
42	57.0	130	176.3
43	58.3	135	183.1
44	60.0	140	190.0
45	61.0	145	197.0
46	62.4	150	203.4
47	63.7	155	210.2
48	65.1	160	217.0
49	66.4	165	224.0
50	67.8	170	231.0
51	69.2	175	237.3
52	70.5	180	244.1
53	71.9	185	251.0
54	73.2	190	258.0
55	74.6	195	264.4
56	75.9	200	271.2
57	77.3	225	305.1
58	78.7	250	339.0
59	80.0	275	373.0
60	81.4	300	407.0
61	82.7	350	475.0
62	84.1	400	542.4
63	85.4		

## Torque Conversion

### In.-Lbs. to Newton Meters (Nm)

Ft.-Lbs.	Nm	Ft.-Lbs.	Nm
5	0.565	90	10.17
10	1.13	100	11.30
15	1.70	110	12.40
20	2.26	120	13.60
25	2.83	130	14.70
30	3.39	140	15.80
35	3.96	150	17.00
40	4.52	160	18.10
45	5.09	170	19.20
50	5.65	180	20.30
60	6.78	190	21.50
70	7.91	200	22.60
80	9.04		

## Air Pressure

PSI	kPa*	Bar†
90	620	6.0
95	655	6.5
100	690	7.0

\* Preferred - Approximate to the nearest 5 kPa

† Approximate to the nearest .5 Bar

## Standard Sheet Steel Gauge

Gauge	Decimal	Gauge	Decimal
3	.239	12	.104
4	.224	13	.089
5	.209	14	.074
6	.194	15	.067
7	.179	16	.059
8	.164	17	.053
9	.149	18	.047
10	.134	19	.041
11	.119	20	.035

## Lbs. to Kilograms

Lbs.	Kg.	Lbs.	Kg.
1/16	.028	10	4.536
1/8	.057	11	4.989
3/16	.085	12	5.443
1/4	.113	13	5.987
5/16	.142	14	6.350
3/8	.170	15	6.804
7/16	.198	16	7.257
1/2	.227	17	7.711
9/16	.255	18	8.165
5/8	.283	19	8.618
11/16	.312	20	9.072
3/4	.340	21	9.525
13/16	.369	22	9.979
7/8	.397	23	10.433
15/16	.425	24	10.886
1	.454	25	11.340
2	.907	26	11.793
3	1.361	27	12.247
4	1.814	28	12.701
5	2.268	29	13.154
6	2.722	30	13.608
7	3.175	31	14.061
8	3.629	32	14.515
9	4.082		





# MICHIGAN PNEUMATIC TOOL, Inc.

10650 Cloverdale • P.O. Box 04950 • Detroit, MI 48204-0950

Toll Free: 1-800-521-8104 • Phone: (313) 933-5890 • Fax: 313-933-0440

www.michiganpneumatic.com • e-mail: mpt@michiganpneumatic.com

## Commercial Credit Application

Date	DUNS Number	Purchase Order Required? <input type="checkbox"/> Yes <input type="checkbox"/> No	Taxable? <input type="checkbox"/> Yes <input type="checkbox"/> No	If Tax Exempt, enter Tax Exempt number (certificate copy must be attached)
------	-------------	--	--	---

### Company Information

Full Legal Business Name	Billing Phone Number ( )	E-mail Address	
DBA or AKA	Billing Fax Number ( )	Shipping Phone Number ( )	Shipping Fax Number ( )
Billing Address	City	State	Zip Code
Shipping Address	City	State	Zip Code

### Business Credit Information

Name of Principal(s), Authorized Officer(s) or Owner(s) 1.	Title(s)	Home Address	Phone Number ( )
2.			Phone Number ( )
3.			Phone Number ( )
Name of Person Responsible for Paying Invoices	Title	Phone Number ( )	Number of Employees
Type of Business			
Taxpayer ID Number	In Business Since	Number of Locations	Estimated Annual Sales
Names of Persons Authorized to Make Purchases			
Company Type (check one) <input type="checkbox"/> Sole Proprietorship <input type="checkbox"/> Partnership <input type="checkbox"/> Corporation <input type="checkbox"/> Other (please specify)			

### Trade & Bank References (please supply companies which are well rated with Dun & Bradstreet)

Trade Reference Name	Contact	Phone Number ( )	Fax Number ( )
Address	City	State	Zip Code
Trade Reference Name	Contact	Phone Number ( )	Fax Number ( )
Address	City	State	Zip Code
Trade Reference Name	Contact	Phone Number ( )	Fax Number ( )
Address	City	State	Zip Code
Bank Name	Phone Number ( )	Fax Number ( )	Contact
Checking Account Number			
Bank Address	City	State	Zip
Savings Account Number			

For faster processing of your application, please fill out all information where required. Your assistance will be greatly appreciated. Please enclose your latest year end financial statement and interim statements if possible.

### Guaranty Agreement

In consideration of the extension of credit, granted by Michigan Pneumatic Tool, Inc. ("Seller"), the undersigned does hereby unconditionally guaranty payment of whatever amount the Credit Applicant, named above, shall at any time owe to Seller on account of goods and materials hereafter delivered, furnished or supplied, whether said indebtedness is in the form of notes, bills or open account. This shall be an open and continuing guaranty, and shall continue in force notwithstanding any change in the form of such indebtedness, or renewals of extensions granted by Seller, without obtaining any consent thereto, and until expressly revoked by written notice from me to you, and any such revocation shall not, in any manner, affect my liability as to any indebtedness contracted for prior thereto. The undersigned Guarantor further agrees to pay all expenses, including court costs, attorney's fees paid or incurred by the Seller in collection of any or all amounts owed them by the Credit Applicant or in enforcing this Guaranty Agreement.

This guaranty shall be a continuing, absolute and unconditional guaranty, and shall be enforceable by Seller, its successor or assigns. All diligence in collection or protection, and all presentment, demand, protest, and/or notice of dishonor, default, nonpayment, or of the creation and existence of any and all guaranteed debts, and of any and all extensions of credit and indulgence hereunder, are expressly waived. The liability of the undersigned Guarantor(s) shall be joint and several. Payment from the Guarantor of monies due and owing as a result of this Guaranty Agreement shall be due upon demand by Seller.

The undersigned represents and warrants that all of the information provided in this Commercial Credit Application is true and accurate and that Seller may rely upon it in deciding to grant credit.

If this credit application is approved, I agree to your terms of Net 30 Days. A finance charge of 1-1/2% per month, 18% per annum, will be added on past due invoices.

Print Name: \_\_\_\_\_ Print Name: \_\_\_\_\_

Address: \_\_\_\_\_ Address: \_\_\_\_\_

Sign Individually: \_\_\_\_\_ Sign Individually: \_\_\_\_\_

Date: \_\_\_\_\_ Date: \_\_\_\_\_



# Air Tool Repair Service

Let Michigan Pneumatic Tool Be Your Service Department

- All tools are completely torn down.
- Every part is carefully inspected for wear and tear.
- All worn parts are replaced.
- Every part is thoroughly cleaned and degreased.
- Tools are reassembled to manufacturer's specifications.
- Every tool is inspected with air consumption meters, tachometers and torque calibrators.
- Fast service is standard procedure. Estimates are provided upon request, or when the cost to repair exceeds 50% of the new tool price.



Gena Davidovs, Denis Birger, Ben Rudicil, Charles Cremeans  
Andrew Skakun, Scott Fronczak

**Your Satisfaction with MPT's Quality and Performance is Guaranteed**

## Repair Service Rental Fleet



**Michigan Pneumatic Tool** is here to back you up. Need a tool while your tool is being serviced? Rent a replacement to keep your job site running. **Michigan Pneumatic Tool** stocks a complete line of air tools and material handling equipment. From impact wrenches, rivet busters and hoists to massive tuggers, **Michigan Pneumatic Tool** is standing by to meet your daily demands. Call today for a quote.

## Maintenance and Lubrication

All **Michigan Pneumatic** air tools are built to withstand the most rigorous applications. Receive your money's worth from your tools by maintaining and operating them properly. Proper tool installation, care and regularly scheduled preventive maintenance can more than double tool life. Proper air line filters, regulators and lubricators will also increase tool efficiency.

### Air Supply

Optimum air tool performance is based on a clean, dry air supply that delivers 90 psi of air pressure at the tool, while the tool is running. Lower air pressure will reduce the efficiency of the tool. Air line filters will effectively eliminate moisture and corrosive particles from the air supply. To get the ultimate in performance from your air tool's ample air compressor capacity, proper air hoses and fittings are essential.

### Lubrication

Proper lubrication is the most important requirement in preventive maintenance. The majority of tool failures can be linked to inadequate lubrication. Tools should be oiled daily through the air inlet or through the lubricators. Air line lubricators automatically provide oil to tools allowing them to operate at peak efficiency. Use a light oil similar to a #10 spindle oil, or **Michigan Pneumatic** oil for best results.

### Periodic Inspection

For maximum performance and protection of your air operated equipment, inspect all tools regularly to prevent unnecessary damage and prevent downtime. All air line accessories should be checked on a regular basis.



## **MICHIGAN PNEUMATIC® TOOL, INC.**

10650 Cloverdale  
P.O. Box 04950  
Detroit, Michigan 48204-0950

Featuring tools manufactured by:

### **NPK®**

Nippon Pneumatic Manufacturing Company, Ltd.  
Osaka, Japan

**Call Toll Free: 1-800-521-8104**

Phone: (313) 933-5890 • Fax: (313) 933-0440  
On the Web: [www.michiganpneumatic.com](http://www.michiganpneumatic.com)  
e-mail: [mpt@michiganpneumatic.com](mailto:mpt@michiganpneumatic.com)

Copyright © 2008 Michigan Pneumatic® Tool, Inc. Prices subject to change without notice. Please call for current pricing information.