



Vehicle Services



irtools.com

If your tools aren't working, neither are you



For more than 100 years, professional technicians have relied on Ingersoll Rand for quality and performance on the toughest jobs. Our advanced engineering and manufacturing have set a standard of excellence often copied, but never matched. So, don't settle for less. Count on genuine Ingersoll Rand tools, accessories, and equipment.

You can depend on Ingersoll Rand

- Best-in-class power and durability
- Improved ease of use
- Reduced downtime
- World-wide service network

IR Ingersoll Rand



HAMMERHEAD

LOW PROFILE IMPACTOOL™



2015 MAX

From Ingersoll Rand, the company that invented the Impactool in 1934, comes a revolutionary product that is unlike any other on the market today. The Hammerhead Low-Profile Impactool offers the power of an impact with the reach of a ratchet, and it's going to change the way you work. Say goodbye to awkward extensions and swivel sockets, and watch your productivity soar as you conquer tasks in minutes that once took you hours.

"It's a knuckle saver... It gets into tight spots. You're not taking out half your tool box to get the job done... It' saves time."

- Joe Illan
Community Auto Repair
Union, New Jersey

AWARD-WINNING INNOVATION



Come check out more customer testimonials on our youtube channel at:

www.youtube.com/irtoolscom

IR Ingersoll Rand

Contents



Air Impacttools™ and Accessories 6

Ingersoll Rand air Impacttools are the tools professional mechanics use when nothing else will do the job. They'll break loose a frozen bolt when others can't make it budge. With fewer working parts, simplified maintenance, and less wasted energy, Ingersoll Rand air Impacttools are the finest examples of delivering more power to professional mechanics.



Air Ratchets and Accessories 17

Compact. Convenient. Real time-savers. Air ratchets have become essential elements in every serious toolbox. Ingersoll Rand ratchets combine access and power to make jobs more productive and profitable, and feature unique qualities you won't find anywhere else.



Sockets 21

Backed by an extensive heritage of reliability and innovation, Ingersoll Rand introduces a comprehensive line of industrial-grade sockets that really make an impact.

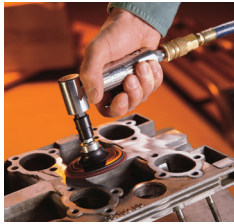

Air Grinders, Cutting Tools and Accessories 28

With high-strength steels, advanced plastics, and new composite materials in today's cars and trucks, you need versatile tools for precise, controlled cutting. Ingersoll Rand cutting tools are the reliable choice of auto body and repair shops, used for everything from muffler and exhaust work to sunroof installations and body repairs.



Air Finishing Tools and Accessories 35

Ingersoll Rand has the most complete line of air finishing tools. Sanders, polishers, and buffers, from traditional styles for heavy material removal to the newest models for excellent control and brilliant surfaces. All Ingersoll Rand finishing tools are designed for long-life and swirl-free finishes.



Air Drills, Screwdrivers, and Accessories 41

Ingersoll Rand air drills have industrial-grade chucks and keyless chuck versions that are extra tough for drilling, sawing, valve guide reaming, cylinder honing, and wire brushing. They are powerful, efficient, and durable with smooth, quiet operation.



Air Hammers and Accessories 45

Our air hammers are designed so you can let the tool do the work, whether it's cutting, punching, chipping, or scraping. Each air hammer comes with a coil spring retainer for fast and easy chisel changes. You can also buy a five-piece chisel set, or get an Ingersoll Rand air hammer kit which includes both the hammer and the chisel set.

Mini Air Tools and Accessories 48

Ingersoll Rand offers a full line of mini air tools — 1/4" & 3/8" mini impacttool, mini random orbital sander, mini polisher, mini surface prep sander, and mini drill driver. All mini tools are also available in a kit.



Air Compressors and System Components 52

For more than 75 years, Ingersoll Rand has been the world leader in air compressors and air system components. We understand rising energy costs and reduced margins require increased reliability and efficiency from not only your air compressor, but your entire air system. Simply stated, your air system is much more than an air compressor. It's the complete system — the piping, filters, dryers, drains, hoses, valves, and point-of-use tools.



Lubrication Equipment and Accessories 67

Ingersoll Rand lubrication equipment reflects the same high standards of performance as our tools and air compressors, with a full range of products that will keep all types of fluids moving efficiently. These products are the result of more than 70 years of experience in pump and air system technology, and include models specifically designed for popular applications.



Accessories 79

We offer an extensive line of accessories to match our tools with the requirements of every job. These accessories put the reliability and quality of Ingersoll Rand behind every job you do.



Pullers and Hoists 90

Ingersoll Rand pullers and hoists are designed to handle tough pulling or lifting jobs with minimal effort by the operator. Whether it's a low-, medium-, or heavy-duty job, you can trust our pullers and hoists to carry the load safely and easily.



Air Impacttools™



There are good reasons why Ingersoll Rand pneumatic Impacttools are so highly regarded by professionals, especially in the automotive service industry. With decades of proven engineering expertise behind them, our Impacttools deliver rugged reliability and power in durable, compact packages. Ingersoll Rand pneumatic Impacttools offer the best power-to-weight ratios available on the market.



| Model | Max Torque ft-lb (Nm) | Working Torque Range ft-lb (Nm) | Free Speed rpm | Weight lb (kg) | Length in (mm) | Average Air Consumption cfm (L/min) | Air Consumption @ Load cfm (L/min) | Sound Pressure / Power dBA | Air Inlet NPTF in | Min Hose Size in (mm) |
|-----------------------------|--------------------------|---------------------------------------|----------------------|-------------------|-------------------|---|---|-------------------------------------|-------------------------|-----------------------------|
| 1/4" MINI IMPACTTOOL | | | | | | | | | | |
| 2101XP | 50 (68) | 25 - 40 (34 - 54) | 11,000 | 1.4 (0.6) | 6.3" (160) | 1.8 (50) | 18.2 (516) | 81.8 / 92.8 | 1/4" | 3/8" (10) |
| 2101XP-QC* | 50 (68) | 25 - 40 (34 - 54) | 11,000 | 1.4 (0.6) | 6.8" (173) | 1.8 (50) | 18.2 (516) | 81.8 / 92.8 | 1/4" | 3/8" (10) |
| 3/8" MINI IMPACTTOOL | | | | | | | | | | |
| 2102XP* | 50 (68) | 25 - 40 (34 - 54) | 11,000 | 1.4 (0.6) | 6.3" (160) | 1.8 (50) | 18.2 (516) | 81.8 / 92.8 | 1/4" | 3/8" (10) |
| 3/8" SQUARE DRIVE | | | | | | | | | | |
| 211* | 150 (204) | 20 - 125 (27 - 170) | 10,000 | 2.40 (1.09) | 6.6" (168) | 2.5 (71) | 11 (311) | 104 / 117 | 1/4" | 3/8" (10) |
| 216B | 200 (271) | 15 - 160 (20 - 217) | 8,500 | 2.8 (1.27) | 7.7 (196) | 3 (85) | 19 (538) | 94.8 / 105.8 | 1/4" (6) | 3/8" (10) |
| 212* | 150 (205) | 20 - 125 (27 - 170) | 11,500 | 2.89 (1.31) | 6" (152) | 2.5 (71) | 11 (311) | 97 / 108 | 1/4" | 3/8" (10) |
| 2015MAX | 180 (244) | 45 - 160 (61 - 217) | 9,000 | 3.4 (1.54) | 13.1 (332) | 3.5 (99) | 19 (538) | 96.6 / 107.6 | 1/4" | 3/8" (10) |
| 2115QTiMAX* | 300 (407) | 25 - 230 (34 - 312) | 15,000 | 2.49 (1.13) | 5.95" (151) | 4 (113) | 17 (481) | 89.7 / 100.7 | 1/4" | 3/8" (10) |
| 2115TiMAX | 300 (407) | 25 - 230 (34 - 312) | 15,000 | 2.48 (1.12) | 5.95" (151) | 4 (113) | 17 (481) | 96.6 / 107.6 | 1/4" | 3/8" (10) |

*Not pictured.

2101XP

1/4" Mini Impacttool

Whether you're working in tight spaces or doing finely detailed finish work, our mini tools deliver the power, versatility, and durability you want, in a conveniently smaller size

- Hard-hitting 5-vane motor delivers smooth and robust performance
- Easily accessible forward / reverse switch for one-handed operation



Fastens conveniently
in hard-to-reach
places

2101K

1/4" Mini Impacttool Kit

- Includes 10-piece 1/4" socket set

2015MAX

Air Impactool

This revolutionary product is unlike any other on the market today. The Hammerhead Low Profile Impactool offers the power and speed of an impact with the reach of a ratchet. The combination of MAX power, MAX control, and MAX access now allows you to use an Ingersoll Rand Impactool for virtually any application. Say goodbye to awkward extensions and swivel sockets, and watch your productivity soar as you conquer tasks in minutes that once took you hours.



MAX Power

With 180 ft-lb max torque and 7,100 rpm, Hammerhead offers more than twice the power of the leading competitor's ratchet.

MAX Control

A feather-touch trigger, two-position forward power regulator, and conveniently located forward/reverse ring provide precise control.

MAX Access

A head height of under 2" and reactionless torque allow you to safely use this powerful tool in tight spaces.

216B

In-line Air Impactool

This durable in-line wrench is handy for the cramped spaces common to small engine repair and other general service work. The butterfly-style throttle valve lets you adjust speed smoothly in either direction in one continuous motion.

- 175 ft-lb max torque
- Contoured composite butterfly throttle for comfort and control
- Recessed regulator dial



2115TiMAX

Air Impactool

The new 2115TiMAX delivers best in class performance for a tool less than six inches long and weighing less than two and a half pounds. The minimal size of this tool will allow greater access to tight spaces, while the minimal weight will reduce operator fatigue all while still delivering MAX performance.



MAX Power

300 ft-lbs max power in reverse - that's best in class power performance

MAX Control

Enhanced power settings, a feather touch trigger and patented push button forward/reverse provide maximum control

MAX Reliability

FREE two-year limited warranty with tool registration

Best power-to-weight
ratio in its class

1/2" Impacttools

| Model | Max Torque ft-lb (Nm) | Working Torque Range ft-lb (Nm) | Free Speed rpm | Weight lb (kg) | Length in (mm) | Average Air Consumption cfm (L/min) | Air Consumption @ Load cfm (L/min) | Sound Pressure / Power dBA | Air Inlet NPTF in | Min Hose Size in (mm) |
|-------------------|--------------------------|---------------------------------------|-------------------|-------------------|-------------------|---|---|-------------------------------------|-------------------------|-----------------------------|
| 1/2" SQUARE DRIVE | | | | | | | | | | |
| 231C | 600 (813)** | 25 – 350 (34 – 475) | 8,000 | 5.8 (2.63) | 7.3" (185) | 4.2 (119) | 22 (623) | 99 / 110 | 1/4" | 3/8" (10) |
| 236* | 450 (610) | 25 – 200 (34 – 271) | 7,400 | 5.3 (2.4) | 7.1" (180.3) | 4.3 (122) | 24 (680) | 90.3 / 101.3 | 1/4" | 3/8" (10) |
| 244A | 500 (678) | 40 – 350 (54 – 475) | 7,000 | 6 (2.72) | 7.3" (185) | 5.4 (153) | 21 (595) | 93 / 104 | 1/4" | 3/8" (10) |
| 244A-2* | 500 (678) | 40 – 350 (54 – 475) | 7,000 | 6.3 (2.85) | 9.5" (241) | 5.4 (153) | 21 (595) | 93 / 104 | 1/4" | 3/8" (10) |
| 231HA* | 590 (800)** | 25 – 350 (34 – 475) | 8,000 | 5.8 (2.63) | 7.3" (185) | 4.2 (119) | 22 (623) | 94 / 105 | 1/4" | 3/8" (10) |
| 231HA-2 | 590 (800)** | 25 – 350 (34 – 475) | 8,000 | 6.1 (2.76) | 9.1" (236) | 4.2 (119) | 22 (623) | 94 / 105 | 1/4" | 3/8" (10) |

*Not pictured.

**Reverse bias.

231C

Air Impactool

The classic 231C is the most popular tool in its class. Introduced over 25 years ago and continuously refined, it offers the sheer power and performance features to tackle the toughest jobs with ease — as well as proven durability and economy.

- Adjustable power regulator
- Pressure-fed lubrication
- Easy-to-service 2-piece construction



The most popular
Impactool in the world

244A

Air Impactool

Bring out the "big gun" for tire-changing, shock and spring work, front-end work, and other heavy automotive and truck work. The impact mechanism pumps out 500 ft-lb of torque at a free speed of 7,000 rpm to get the job done fast.

- Powerful with smooth, balanced blows
- Pressure-fed lubrication system automatically greases the impact mechanism
- Non-biased 500 ft-lb in forward and reverse



231HA-2

Extended Anvil Air Impactool

The 231HA-2 has set the standard for Impactool performance for over three decades. Refined engineering and design have perfected performance and made the 231HA-2 one of the most popular tire service Impactools ever. This elite mechanism is the perfect balance between superior power and proven durability.

- Pressure-fed lubrication system
- Handle exhaust directs air away from user
- Adjustable power regulation



Top choice in tire
service centers

Sockets

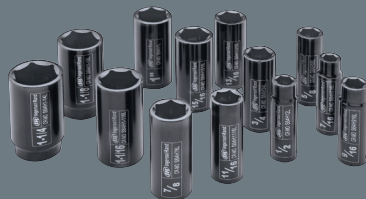

Genuine Ingersoll Rand Impact sockets are built with top-quality materials for performance and durability. For more information, turn to the sockets section — starting on page 21. See pages 14 – 16 for all other Impactool accessories.

| Model | Max Torque ft-lb (Nm) | Working Torque Range ft-lb (Nm) | Free Speed rpm | Weight lb (kg) | Length in (mm) | Average Air Consumption cfm (L/min) | Air Consumption @ Load cfm (L/min) | Sound Pressure / Power dBA | Air Inlet NPTF in | Min Hose Size in (mm) |
|-------------------|--------------------------|------------------------------------|-------------------|-------------------|-------------------|--|---------------------------------------|-------------------------------|-------------------------|--------------------------|
| 1/2" SQUARE DRIVE | | | | | | | | | | |
| 2025MAX* | 180 (244) | 45-160 (61-217) | 9,000 | 3.4 (1.54) | 13.1 (332) | 3.5 (99) | 19 (538) | 96.6/107.6 | 1/4" | 3/8" (10) |
| 2125QTiMAX* | 332 (450)** | 25 - 251 (34 - 340) | 15,000 | 2.51 (1.14) | 6.1" (155) | 4 (113) | 17 (481) | 89.7 / 100.7 | 1/4" | 3/8" (10) |
| 2130 | 550 (745)** | 50 - 500 (68 - 680) | 9,500 | 4.2 (1.9) | 7.25" (184) | 4.4 (124.6) | 22 (623) | 96.6 / 109.6 | 1/4" | 3/8" (10) |
| 2130-2* | 550 (745)** | 50 - 500 (68 - 680) | 9,500 | 4.6 (2.05) | 9.25" (235) | 4.4 (124.6) | 22 (623) | 96.6 / 109.6 | 1/4" | 3/8" (10) |
| 232TGSL | 625 (847)** | 40 - 400 (54 - 544) | 10,000 | 6 (2.72) | 7.3" (185) | 5.4 (153) | 23 (651) | 105 / 109.3 | 1/4" | 3/8" (10) |

*Not pictured.

**Reverse bias.

2130

Air Impactool

The 2130 has all the performance features you have come to expect from the Ingersoll Rand family of Impacttools. This Impacttool features a powerful twin-hammer mechanism and a composite housing, providing superior ergonomics in a lightweight package.

- 550 ft-lb maximum torque
- Full-stroke tease throttle
- Multi-position power management



Ingersoll Rand power and durability at an exceptional value

232TGSL

ThunderGun® Street Legal™ Air Impactool

As close as you can get to the real racing tools used by 100 percent of NASCAR® pit crews. It features 625 ft-lb of torque in reverse, with 10,000 rpm to deliver pit crew power, speed, and durability.

- Our fastest 1/2" Impactool
- 10,000 rpm for lightning fast removal is best-in-class
- 625 ft-lb of torque



Impact Boots



Even the industry's hardest-working Impacttools could use added protection from the rigors of the jobsite. Our impact boots can be found on page 16. For a complete listing of Impacttool accessories, see pages 14 - 16.

1/2" Impacttools

| Model | Drive in | Max Torque (reverse) ft-lb (Nm) | Nut Busting Torque ft-lb (Nm) | Forward Torque Range ft-lb (Nm) | Blows per minute | Free Speed rpm | Sound Pressure / Power dBA | Net Weight lb (kg) | Overall Length in (mm) | Average Air Consumption cfm (L/min) | Air Inlet NPTF in | Min Hose Size in (mm) |
|-------------------|----------|---------------------------------|-------------------------------|---------------------------------|------------------|----------------|----------------------------|--------------------|------------------------|-------------------------------------|-------------------|-----------------------|
| 1/2" SQUARE DRIVE | | | | | | | | | | | | |
| 2135TiMAX | 1/2" | 780 (1054) | 1,100 (1486) | 50 – 550 (68 – 746) | 1,250 | 9,800 | 109 | 3.95 (1.79) | 7.35 (186.7) | 5 (142) | 1/4" | 3/8" (10) |
| 2135Ti-2MAX* | 1/2" | 780 (1054) | 1,100 (1486) | 50 – 550 (68 – 746) | 1,250 | 9,800 | 109 | 4.4 (1.99) | 9.47 (240.5) | 5 (142) | 1/4" | 3/8" (10) |
| 2135QTiMAX* | 1/2" | 780 (1054) | 1,100 (1486) | 50 – 550 (68 – 746) | 1,250 | 9,800 | 86 | 4.05 (1.83) | 7.35 (186.7) | 5 (142) | 1/4" | 3/8" (10) |
| 2135QTi-2MAX* | 1/2" | 780 (1054) | 1,100 (1486) | 50 – 550 (68 – 746) | 1,250 | 9,800 | 86 | 4.5 (2.04) | 9.47 (240.5) | 5 (142) | 1/4" | 3/8" (10) |

*Not pictured.

**Reverse bias.

2135TiMAX

Air Impact Wrench

The Titanium 2135TiMAX delivers 1,100 ft-lb of nut-busting torque in a gun that weighs just 3.95 lb. The 7-vane power plant drives enough torque to break away a nut tightened to over 1,100 ft-lb in under six seconds.

MAX Power

780 ft-lb maximum reverse torque from a tool weighing less than 4 lb. — that's the best power-to-weight ratio in its class

MAX Control

Feather-touch trigger, wider range of power regulator settings in forward, always max power in reverse, patented one-hand forward / reverse control

MAX Reliability

Free two-year limited warranty with tool registration



The best power-to-weight ratio in its class



Quiet Tools

All the power, without all the noise.

At Ingersoll Rand, we don't just stand behind our tools; we're equally devoted to the people who use them. We're constantly looking for ways to make your job easier.

With the innovative line of Quiet Tools from Ingersoll Rand, you get durable, reliable tools that deliver the power you need, but with less noise. Our patented Quiet Tool technology reduces the sound levels caused by air pulsating through the impact motor, without compromising our best-in-class torque levels.

Power and performance with less noise? Sure sounds good to us.

Models: 2115QTiMAX, 2125QTiMAX, 2135QTiMAX, 2135QTi-2MAX

Impactool Tune-up Kits

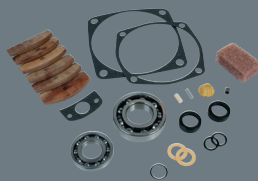

Extend the life of your tools. Even the most durable and reliable tools need preventive maintenance. Our Impactool tune-up kits and full line of Impactool accessories can be found on pages 14 – 16.

3/4" Impacttools

| Model | Max Torque ft-lb (Nm) | Working Torque Range ft-lb (Nm) | Free Speed rpm | Weight lb (kg) | Length in (mm) | Average Air Consumption cfm (L/min) | Air Consumption @ Load cfm (L/min) | Sound Pressure / Power dBA | Air Inlet NPTF in | Min Hose Size in (mm) |
|-------------------|--------------------------|---------------------------------------|-------------------|-------------------|-------------------|---|---|-------------------------------------|-------------------------|-----------------------------|
| 3/4" SQUARE DRIVE | | | | | | | | | | |
| 259 | 1050 (1424) | 200 – 800 (271 – 1085) | 6,000 | 8.8 (4.0) | 8.6 (218) | 8 (227) | 30 (850) | 91.6/102.6 | 3/8" | 3/8" (10) |
| 261 | 1,100 (1491) | 200 – 900 (272 – 1224) | 5,500 | 12.4 (5.62) | 8.8" (224) | 9.5 (269) | 38 (1076) | 98.1 / 109.1 | 3/8" | 1/2" (13) |
| 261-3* | 1,100 (1491) | 200 – 900 (272 – 1224) | 5,500 | 13 (5.9) | 11.8" (300) | 9.5 (269) | 38 (1076) | 98.1 / 109.1 | 3/8" | 1/2" (13) |
| 261-6* | 1,100 (1491) | 200 – 900 (272 – 1224) | 5,500 | 13.7 (6.21) | 14.8" (376) | 9.5 (269) | 38 (1076) | 98.1 / 109.1 | 3/8" | 1/2" (13) |
| 2141 | 1,200 (1627) | 200 – 900 (272 – 1224) | 8,000 | 7 (3.2) | 8.2" (208) | 9.5 (269) | 40 (1133) | 99.9 / 110.9 | 3/8" | 1/2" (13) |
| 2161XP | 1,250 (1695) | 300 – 1,000 (459 – 1654) | 6,000 | 11.8 (5.35) | 8.5" (216) | 10 (283) | 46 (1303) | 98 / 111 | 3/8" | 1/2" (13) |
| 2161XP-6* | 1,250 (1695) | 300 – 1,000 (459 – 1654) | 6,000 | 13.1 (5.95) | 14.5" (368) | 10 (283) | 46 (1303) | 98 / 111 | 3/8" | 1/2" (13) |

*Not pictured.

261

Air Impactool

The highly regarded 261 model combines compact size at only 8.8" long with high output, which makes it perfect for everything from spring work to pinion nut and track pad removal and major engine teardowns.

- Jumbo hammer mechanism
- Up to 1,100 ft-lb of torque
- Pressure-fed lube system for trouble-free performance and longer life

For optional power regulator, please order part #2920-K329.



259

Air Impactool

The new 259 3/4" Impactool™ delivers the power, durability, reliability, and value to get the job done right. It offers impressive performance, value, and convenience not found in competitive models.

- Smaller and up to 2 pounds (.91 kg) lighter than other 3/4" impacts in its class
- Rocking dog impact mechanism works well on a wide range of air pressures
- Silenced exhaust reduces tool noise while in use



2141

Air Impactool

The 2141 delivers the best power-to-weight ratio and best size ratio in its class. The 2141 also provides great maneuverability for tight, awkward spaces.

- 1,200 ft-lb maximum torque
- Weighs just 7 lb
- Contoured professional touch trigger and ergonomically designed handle for increased comfort



The best power-to-weight ratio in its class

2161XP

Air Impactool

The 2161XP combines a 6-vane, high-output air motor, through-bolt construction, ergonomic handle and housing design to create an Impactool that offers increased power and durability.

- Most powerful 3/4" Impactool in the industry
- Maximum torque of 1,250 ft-lb
- 3-position power regulator and 360° swivel inlet



1" Impacttools

| Model | Max Torque ft-lb (Nm) | Working Torque Range ft-lb (Nm) | Free Speed rpm | Weight lb (kg) | Length in (mm) | Average Air Consumption cfm (L/min) | Air Consumption @ Load cfm (L/min) | Sound Pressure / Power dBA | Air Inlet NPTF in | Min Hose Size in (mm) |
|------------------------|--------------------------|---------------------------------------|--------------------------|-------------------|-------------------|---|---|-------------------------------------|-------------------------|-----------------------------|
| 1" SQUARE DRIVE | | | | | | | | | | |
| 271 | 1,100 (1491) | 200 – 900 (272 – 1224) | 5,500 | 12.5 (5.67) | 8.9" (226) | 9.5 (269) | 39 (1104) | 98.1 / 109.1 | 3/8" | 1/2" (13) |
| 285B* | 1,475 (2000) | 100 – 900 (136 – 1220) | 5,000 | 24.6 (11.16) | 13.2" (335) | 10 (283) | 37 (1048) | 103.4 / 114.4 | 1/2" | 1/2" (13) |
| 285B-6 | 1,475 (2000) | 100 – 900 (136 – 1220) | 5,000 | 27.8 (12.61) | 20.1" (511) | 10 (283) | 37 (1048) | 103.4 / 114.4 | 1/2" | 1/2" (13) |
| 280* | | 1,600 (2169) | 150 – 1,000 (204 – 1360) | | 6,000 | 22 (9.98) | | 13" (330) | 10 (283) | 55 (1557) |
| 122.11/2" | 1/2" (13) | | | | | | | | | 109.1 / |
| 280-6 | 1,600 (2169) | 150 – 1,000 (204 – 1360) | 6,000 | 23.8 (10.80) | 18.5" (470) | 10 (283) | 55 (1557) | 109.1 / 122.1 | 1/2" | 1/2" (13) |
| #5 SPLINE DRIVE | | | | | | | | | | |
| 285B-S6* | 1,475 (2000) | 100 – 900 (136 – 1220) | 5,000 | 27.8 (12.61) | 20.1" (511) | 10 (283) | 37 (1048) | 103.4 / 114.4 | 1/2" | 1/2" (13) |
| *280-S-6* | 1,600 (2169) | 150 – 1,000 (204 – 1360) | 6,000 | 23.8 (10.80) | 18.5" (470) | 10 (283) | 55 (1557) | 109.1 / 122.1 | 1/2" | 1/2" (13) |

271

Air Impactool

The shortest 1" air Impactool is also one of the most powerful. It combines a compact size with high power output, making it ideal for tire changing, spring work, pinion nut removal, tractor pad removal, and shock work.

- Impressive power-to-size ratio
- Up to 1,100 ft-lb of torque
- Pressure-fed lube system for longer service life



280-6

Air Impactool

High-production truck tire changing requires the brute force only this jumbo hammer impact mechanism delivers. Reach into deep truck wheels easily with this 6" extended anvil wrench, designed for high-production truck tire changing.

- 1,600 ft-lb of maximum torque
- Jumbo power mechanism for power and durability
- In-handle exhaust directs air away from user



285B-6

Air Impactool

The 285B models combine exceptional power, control and durability. They deliver 1,770 ft-lb of maximum torque @ 120 psi, with 5,250 rpm free speed and a high-efficiency, 6-vane motor. The swept-back 285B handle provides excellent maneuverability.

- Delivers 1,475 ft-lb maximum torque
- Fast-torque™ delivers 1,000 ft-lb in 2 seconds
- Improved feather touch trigger



Enhanced durability
for longer life



| Model | Max Torque ft-lb (Nm) | Working Torque Range ft-lb (Nm) | Free Speed rpm | Weight lb (kg) | Length in (mm) | Average Air Consumption cfm (L/min) | Air Consumption @ Load cfm (L/min) | Sound Pressure / Power dBA | Air Inlet NPTF in | Min Hose Size in (mm) |
|------------------------|-----------------------|---------------------------------|----------------|----------------|----------------|-------------------------------------|------------------------------------|----------------------------|-------------------|-----------------------|
| 1" SQUARE DRIVE | | | | | | | | | | |
| 2171XP | 1,250 (1695) | 300 – 1000 (459 – 1654) | 6,000 | 13.1 (5.95) | 12.5" (318) | 10 (282) | 46 (1303) | 98 / 111 | 3/8" | 1/2" (13) |
| 295A | 1,475 (2000) | 100 – 900 (136 – 1220) | 5,000 | 22.3 (10.12) | 10.5" (267) | 10 (283) | 45 (1274) | 101.1 / 112.1 | 1/2" | 1/2" (13) |
| 290 | 1,600 (2169) | 150 – 1,000 (203 – 1356) | 6,000 | 21.9 (9.93) | 9.75" (248) | 10 (283) | 60 (1699) | 104.6 / 117.6 | 1/2" | 3/4" (19) |
| 2190Ti* | 1,650 (2237) | 150 – 1,000 (203 – 1627) | 6,800 | 14 (6.4) | 15.38" (391) | 12 (336) | 58 (1642) | 103.8 / 116.8 | 1/2" | 1/2" (13) |
| 2190Ti-6 | 1,650 (2237) | 150 – 1,000 (203 – 1627) | 6,800 | 15.5 (7.03) | 21.48" (546) | 12 (336) | 58 (1642) | 103.8 / 116.8 | 1/2" | 1/2" (13) |
| 2190DTi-6* | 1,650 (2237) | 150 – 1,000 (203 – 1627) | 6,800 | 16 (7.3) | 21.48" (546) | 12 (336) | 58 (1642) | 103.8 / 116.8 | 3/8" | 1/2" (13) |
| 293* | 2,000 (2712) | 1,000 – 1,600 (1360 – 2176) | 3,500 | 22.8 (10.34) | 11.3" (287) | 12 (340) | 64 (1812) | 90.3 / 103.3 | 1/2" | 3/4" (19) |
| #5 SPLINE DRIVE | | | | | | | | | | |
| 290-S* | 1,600 (2169) | 150 – 1,000 (203 – 1356) | 6,000 | 21.9 (9.93) | 10" (254) | 10 (283) | 60 (1699) | 104.6 / 117.6 | 1/2" | 3/4" (19) |
| 293-S* | 2,000 (2712) | 1,000 – 1,600 (1360 – 2176) | 3,500 | 22.8 (10.34) | 11.3" (287) | 12 (340) | 64 (1812) | 90.3 / 103.3 | 1/2" | 3/4" (19) |

*Not pictured.

2171XP

Air Impactool

The 2171XP combines a 6-vane high output air motor, through-bolt construction, ergonomic handle and housing design to create an Impactool that offers increased power and durability.

- Maximum torque of 1,250 ft-lb
- 3-position power regulator
- 360° swivel inlet



290

Air Impactool

Designed for getting into cramped spaces with big power, the 290 has a 3-way adjustable handle. It's a good choice for spring work, tractor pads, bus maintenance, off-road equipment, and farm equipment.

- Up to 1,600 ft-lb of torque

For optional thread-on muffler, order part #2910-674.



2190Ti-6

Air Impactool

Designed specifically for high-volume fleet service, the revolutionary chainsaw-grip handle provides comfortable control to the operator. The 2190Ti-6 delivers an impressive 1,650 ft-lb of maximum torque in a lightweight package and comes standard with a 6" extended anvil.

- 1,650 ft-lb of maximum torque
- Weighs 15.5 lb
- Extended robust anvil bushing provides long life under heavy shop usage

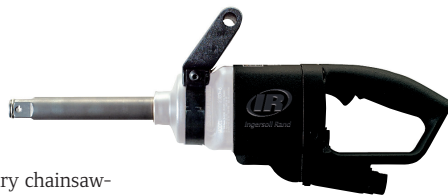

295A

Air Impactool

The 295A model combines exceptional power, control, and durability. It delivers 1,770 ft-lb of maximum torque @ 120 psi (1,475 ft-lb @ 90 psi), with 5,250 rpm free speed and a high-efficiency, 6-vane motor. The top-mounted 295A dead handle provides great leverage for difficult underbody work.

- Delivers 1,770 ft-lb maximum torque
- Fast-torque™ delivers 1,000 ft-lb in 2 seconds
- Improved feather touch trigger
- Rubber boots protect tools from exterior damage



Impactool Hammer Kit



See pages 14 – 16 for our full line of Impactool accessories.

Impactool Tune-up Kits

Extend the life of your tools with genuine Ingersoll Rand repair kits and replacement parts. Every Ingersoll Rand part is specifically designed to enhance durability and improve the productivity of your tool.

| Part Number | For Use With |
|------------------------------------|-------------------------------|
| 3/8" IMPACTOOL TUNE-UP KITS | |
| 2015-TK | 2015MAX |
| 211-TK2 | 211 |
| 212-TK2 | 212 |
| 2115-TK2 | 2115TiMAX Series |
| 1/2" IMPACTOOL TUNE-UP KITS | |
| 2015-TK | 2025MAX |
| 2130-TK1 | 2130, 2130-2 |
| 2135-TK2 | 2135 Series, 2135TiMAX Series |
| 236-TK1 | 236 |
| 231HP-TK1 | 231HA, 231HA-2 |
| 231-TK2 | 2141 |
| 231-TK3 | 231C |
| 244-TK2 | 244A, 244A-2 |

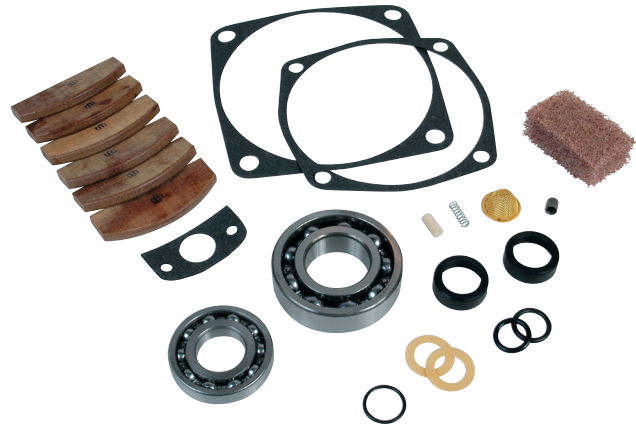

| Part Number | For Use With |
|------------------------------------|-----------------------------|
| 3/4" IMPACTOOL TUNE-UP KITS | |
| 259-TK1 | 259 |
| 261-TK2 | 261, 261-3, 261-6, 271 |
| 2141-TK1 | 2141 |
| 2161-TK2 | 2161XP, 2161XP-6 |
| 1" IMPACTOOL TUNE-UP KITS | |
| 280-TK2 | 280, 280-6, 280-S6 |
| 285B-TK1 | 285B, 285B-6, 285B-S6 |
| 295A-TK1 | 295A |
| 2190-TK1 | 2190Ti, 2190DTi-6, 2190Ti-6 |
| 290-TK2 | 290 |

Impactool Hammer and Anvil Kits

| Part Number | For Use With |
|---|---------------------------|
| 3/8" IMPACTOOL HAMMER AND ANVIL KITS | |
| 2112-THK1 | 2112 |
| 2115-THK2 | 2115TiMAX Series |
| 1/2" IMPACTOOL HAMMER AND ANVIL KITS | |
| 2135-THK1 | 2135TiMAX, 2135QTiMAX |
| 2135-2-THK1 | 2135Ti-2MAX, 2135QTi-2MAX |
| 231B-THK1 | 231C, 231HA, 244A |
| 231B-THK2 | 231HA-2, 244A-2 |
| 231C-THK1 | 231C |
| 3/4" IMPACTOOL HAMMER AND ANVIL KITS | |
| 261-THK1 | 261 |
| 2141-THK1 | 2141 |
| 1" IMPACTOOL HAMMER AND ANVIL KITS | |
| 2190-THK1 | 2190Ti |
| 285A-6-THK1 | 285B |
| 2190-6-THK1 | 2190Ti-6, 2190DTi-6 |



If your tools aren't working, neither are you! Protect your tools with genuine Ingersoll Rand parts and services.

Air Tool Lubricants

Regular tool lubrication will keep your tool running at peak performance for a longer time. Our full line of air tool lubricants can be found on page 96.

Ergonomic Accessories

Ingersoll Rand offers a handy line of ergonomic accessories that enable you to work more safely and more comfortably. Our tool boots absorb vibrations and protect the tool from external damage. Ingersoll Rand comfort grips protect you from mechanical shocks and tool vibration, and our braces allow for more consistent torque output and eliminate the need for a dead handle.

Protective Tool Boots

| Part Number | Description | For Use With |
|-----------------------|---|---|
| PROTECTIVE TOOL BOOTS | | |
| 212-BOOT | Impactool boot with Ingersoll Rand logo printed on red boot | 212 |
| 2115M-BOOT | Premium Impactool boot with Ingersoll Rand logo | 2115TiMAX Series |
| 2130-BOOT | Premium Impactool boot with Ingersoll Rand logo | 2130, 2130-2 |
| 2135M-BOOT | Premium Impactool boot with Ingersoll Rand logo | 2135TiMAX, 2135Ti-2MAX, 2135QTiMAX, 2135QTi-2MAX, 2135QPTiMAX |
| 2015-BOOT | Premium Impactool boot with Ingersoll Rand logo | 2015MAX, 2025MAX |
| 2141-BOOT | Premium Impactool boot with Ingersoll Rand logo | 2141 |
| 259-BOOT | Premium Impactool boot with Ingersoll Rand logo | 259 |
| 2161-BOOT | Impactool boot with Ingersoll Rand logo printed on red boot | 2161XP, 2161XP-6 |
| 2190-BOOT | Premium Impactool boot with Ingersoll Rand logo | 2190Ti, 2190Ti-6 |

- Specifically designed for use with our air Impacttools
- Keep your tools clean and protected from external damage



212-BOOT



2135M-BOOT



2015-BOOT



232TGSL-P32

| Part Number | Description | For Use With |
|-----------------------|---|----------------------|
| PROTECTIVE TOOL BOOTS | | |
| 236-BOOT | Impactool boot with Ingersoll Rand logo printed on red boot | 236 |
| 244-BOOT | Impactool boot with Ingersoll Rand logo printed on red boot | 244A, 244A-2 |
| 261-BOOT | Impactool boot with Ingersoll Rand logo printed on red boot | 261, 261-3, 261-6 |
| 285-BOOT | Impactool boot with Ingersoll Rand logo printed on red boot | 285B, 285B-6 |
| 295-BOOT | Impactool boot with Ingersoll Rand logo printed on red boot | 295, 295-S |
| 231-BOOT | Impactool boot with Ingersoll Rand logo printed on red boot | 231C, 231HA, 231HA-2 |
| 232TGSL-P32 | ThunderGun Street Legal Impactool boot | 232TGSL |

285B Replacement Boots

| Part Number | Description | For Use With |
|-----------------------|----------------------------|-----------------------|
| PROTECTIVE TOOL BOOTS | | |
| 431L-62 | Rubber hammer case guard | 285B, 285B-6, 285B-S6 |
| 431L-32 | Rubber motor housing guard | 285B, 285B-6, 285B-S6 |



431L-62



431L-32

Light Holder Boots

| Part Number | Description | For Use With |
|----------------|---|------------------|
| 2115M-BOOT-LED | Premium boot with LED flashlight holder (kit includes LED flashlight) | 2115TiMAX Series |
| 231-BOOT-LED | Premium boot with LED flashlight holder (kit includes LED flashlight) | 231 |
| 2135M-BOOT-LED | Premium boot with LED flashlight holder (kit includes LED flashlight) | 2135TiMAX Series |



2115M-BOOT-LED



231-BOOT-LED



2135M-BOOT-LED

Air Ratchets



For more than 100 years, Ingersoll Rand has been designing world-class tools of the highest quality, durability, and reliability. This legacy of excellence and performance is evident in our line of pneumatic ratchets. Smaller in size and more powerful than competitive models, our ratchets are specifically engineered to make your job easier and you more productive. Our ratchets are also very convenient to use, thanks to enhanced ergonomics.



Air Ratchets

| Model | Square Drive | Max Torque ft-lb (Nm) | Free Speed rpm | Weight lb (kg) | Length in (mm) | Average Air Consumption cfm (L/min) | Average Air Consumption @ Load cfm (L/min) | Sound Pressure / Power dBA | Air Inlet NPTF in | Min Hose Size in (mm) |
|--------------------------|--------------|-----------------------|----------------|----------------|----------------|-------------------------------------|--|----------------------------|-------------------|-----------------------|
| 1/4" SQUARE DRIVE | | | | | | | | | | |
| 105-D2 | 1/4" | 25 (34) | 250 | 1.4 (0.64) | 7.3 (186) | 3 (85) | 18 (510) | 81.8/92.8 | 1/4" | 3/8" |
| 105-L2 | 1/4" | 25 (34) | 250 | 1.56 (0.71) | 8.41 (214) | 3 (85) | 18 (510) | 81.6/92.6 | 1/4" | 3/8" |
| 1105MAX-D21/4" | | 30 (41) | 300 | 1.43 (0.65) | 7.36 (187) | 3.5 (99) | 20 (566) | 88.9/99.9 | 1/4" | 3/8" |
| 3/8" SQUARE DRIVE | | | | | | | | | | |
| 105-D3* | 3/8" | 25 (34) | 250 | 1.4 (0.64) | 7.3 (186) | 3 (85) | 18 (510) | 81.8/92.8 | 1/4" | 3/8" |
| 1105MAX-D33/8" | | 30 (41) | 300 | 1.43 (0.65) | 7.36 (187) | 3.5 (99) | 20 (566) | 88.9/99.9 | 1/4" | 3/8" |

*Not pictured.

105-D2

Air Ratchet Wrench

The Ingersoll Rand 105 series air ratchets offer professional technicians an outstanding combination of value and performance, delivering impressive comfort and durability.

- 25 ft-lb max torque
- Low profile forward/reverse control
- Head construction offers increased durability
- Ergonomic design



105-L2

Air Ratchet Wrench

The Ingersoll Rand 105 series air ratchets offer professional technicians an outstanding combination of value and performance, delivering impressive comfort and durability. The extended head of the 105-L2 offers longer reach.

- 25 ft-lb max torque
- Low profile forward/reverse control
- Head construction offers increased durability
- Ergonomic design



1105MAX-D2

Air Ratchet Wrenches

With the 1105MAX series air ratchets, you get best-in-class power and speed coupled with superior features to give you MAX power, MAX control, and MAX comfort.

(Also available in 3/8" drive: 1105MAX-D3)

MAX Power

30 ft-lb of torque combined with 300 rpm provides optimal torque/speed combination.

MAX Control

Easily accessible variable power regulator combined with feather touch lever offers unprecedented control.

MAX Comfort

Ergonomic coupling nut improves handle comfort and composite handle insulates against cold.



Air Ratchet Repair Kits

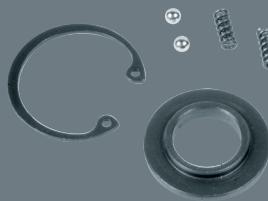

Keep your Ingersoll Rand air ratchet running strong with our genuine repair kits and parts — found on page 20.

Air Ratchets

| Model | Square Drive | Max Torque ft-lb (Nm) | Free Speed rpm | Weight lb (kg) | Length in (mm) | Average Air Consumption cfm (L/min) | Average Air Consumption @ Free Speed cfm (L/min) | Sound Pressure / Power dBA | AirInlet NPTF in | Min Hose Size in (mm) |
|--------------------------|--------------|-----------------------|----------------|----------------|----------------|-------------------------------------|--|----------------------------|------------------|-----------------------|
| 3/8" SQUARE DRIVE | | | | | | | | | | |
| 107XPA | 3/8" | 54 (73) | 160 | 2.75 (1.25) | 11" (279) | 4 (85) | 19 (510) | 94.4 / 100.4 | 1/4" | 3/8" |
| 109XPA | 3/8" | 76 (95) | 220 | 3.3 (1.4) | 12" (302) | 4 (113) | 24 (680) | 92.4 / 103.4 | 1/4" | 3/8" |
| 1207MAX-D3 | 3/8" | 65 (88) | 200 | 3.2 (1.45) | 10.8 (275) | 4 (113) | 23 (651) | 85.0/96.0 | 1/4" | 3/8" |
| 1/2" SQUARE DRIVE | | | | | | | | | | |
| 1077XPA* | 1/2" | 54 (73) | 160 | 2.75 (1.25) | 11" (279) | 4 (85) | 19 (510) | 94.4 / 105.4 | 1/4" | 3/8" |
| 1099XPA* | 1/2" | 76 (95) | 220 | 3.3 (1.4) | 12" (302) | 4 (113) | 24 (680) | 92.4 / 103.4 | 1/4" | 3/8" |
| 1207MAX-D4* | 1/2" | 65 (88) | 200 | 3.2 (1.45) | 10.8 (275) | 4 (113) | 23 (651) | 85.0/96.0 | 1/4" | 3/8" |

*Not pictured.

Air Ratchets

107XPA

Air Ratchet Wrench

Based on the industry's most popular ratchet, the 107XPA delivers an extra measure of durability with an advanced head design, plus a host of other features.

- 54 ft-lb maximum torque
- 360° adjustable exhaust directs air away from the operator and the work
- Variable speed lever-style throttle



109XPA

Air Ratchet Wrench

Optimized gear ratio and airflow for extra performance, coupled with exceptional durability.

- 76 ft-lb maximum torque at 220 rpm free speed • 360° adjustable exhaust directs air away from the operator and the work
- Variable speed button trigger



1207MAX-D3

Air Ratchet Wrenches

As a member of the Ingersoll Rand family of MAX tools, the 1207MAX series air ratchets combine best-in-class performance and a full complement of premium features to give professional technicians MAX Power, MAX Control, and MAX Comfort. It's another in the long line of tools designed to help make your job easier — and you more productive.

(Also available in 1/2" drive: 1207MAX-D4)

| | |
|--------------------|--|
| MAX Power | 65 ft-lb of maximum torque ensures enough power for tough applications. |
| MAX Control | Innovative forward/reverse collar, variable-speed power regulator, adjustable exhaust, and feather-touch trigger combine to offer unprecedented control. |
| MAX Comfort | Ergonomic composite handle is comfortable for extended use. |



Air Ratchet Boots



Even the industry's hardest-working air ratchets could use added protection from the rigors of the jobsite. Our air ratchet boots and accessories can be found on page 20

Air Ratchet Accessories

Extend the life of your tools with genuine Ingersoll Rand repair kits and replacement parts. Every Ingersoll Rand part is specifically designed to enhance durability and improve the productivity of your tool.

Air Ratchet Repair Kits

| Part Number | For Use With |
|-------------|-----------------|
| 107XPA-SK | 107XPA, 1077XPA |
| 109XPA-SK | 109XPA, 1099XPA |

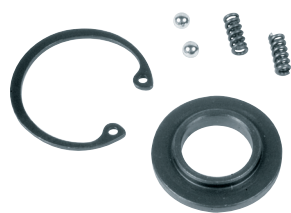

1077XPA-SK



1107-TRK1

Air Ratchet Head Repair Kits

| Part Number | For Use With |
|--------------|----------------------------|
| 103A-TRK-1 | 103A, 104B |
| 1033A-TRK1 | 1033A |
| 107XPA-TRK1 | 107XPA |
| 1077XPA-TRK1 | 1077XPA |
| 109XPA-TRK1 | 109XPA |
| 1099XPA-TRK1 | 1099XPA |
| 1105-D2-TRK1 | 1105MAX-D2, 105-D2, 105-L2 |
| 1105-D3-TRK1 | 1105MAX-D3, 105-D3 |
| 1207-D3-TRK1 | 1207MAX-D3 |
| 1207-D4-TRK1 | 1207MAX-D4 |
| 1215-TRK1 | 1215Ti |
| 1225-TRK1 | 1225Ti |

Air Ratchet Tune-up Kits

| Part Number | For Use With |
|-------------|-----------------|
| 107XPA-TK1 | 107XPA, 1077XPA |
| 109XPA-TK1 | 109XPA, 1099XPA |



1200-TK1

Boots

| Part Number | Description | For Use With |
|-------------|--|--|
| 103-BOOT | Ratchet head boot with Ingersoll Rand logo printed on red boot | 105-D2, 105-D3, 105-L2, 1105MAX-D2, 1105MAX-D3 |
| 107-BOOT | Ratchet head boot with Ingersoll Rand logo printed on red boot | 107XP, 107XPA, 1077XP, 1077XPA, R380 |
| 109-BOOT | Ratchet head boot with Ingersoll Rand logo printed on red boot | 109XP, 109XPA, 1099XP, 1099XPA |



107-BOOT

Sockets



Backed by a proud heritage of reliability and innovation, Ingersoll Rand introduces a comprehensive line of industrial-grade sockets consistent with the quality of our best-in-class Impactools.

- Impact-grade chrome-molybdenum steel provides the durability you expect from a global leader
- Highly visible laser etching for easy size identification
- Nearly 800 Impactool socket items for virtually any assembly or disassembly job
- Lifetime warranty

From air compressors to Impactools to sockets (and everything in between), Ingersoll Rand provides the toughest, highest quality products available.

Features and Benefits

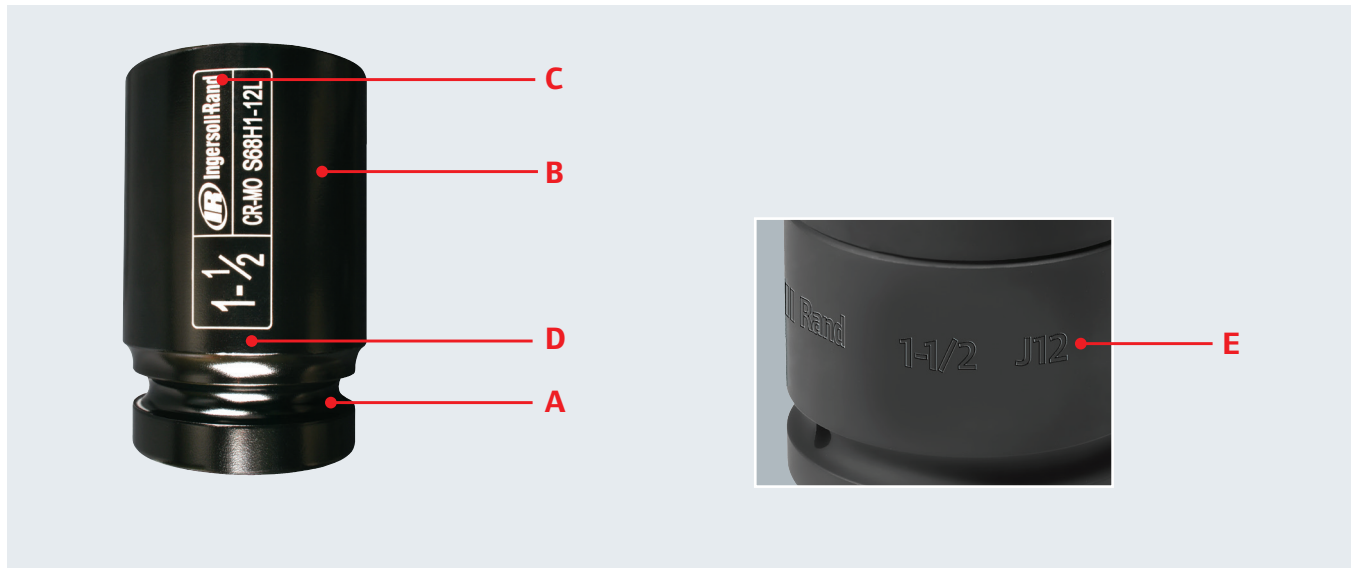

| Features | Benefits |
|--|---|
| A Impact-grade toughness | Designed for high-torque applications |
| B Chrome-molybdenum steel | Forged for high-strength durability |
| C Laser-etched size labeling | Enables easy size identification |
| D Electro-phosphate finish on 1/4" to 1" drive sizes | Projects a sleek look and high visibility |
| E Durable roll stamp feature on 1-1/2", 2-1/2", and #5 Spline drive sizes | Enables easy size identification in harsh work environments |
| Backed by a Lifetime Warranty | Provides peace of mind with proven reliability |

Model Number Configurator

S64H78U

SK3M8L

Single Item

| S | 6 | 4 | H | 78 | U |
|---|--|--|-----------------------------------|--|---|
| Socket Type | Output Type | Drive Size | SAE or Metric | Across Flats | Socket Length |
| A= Adapter E= Extension J= Universal Joint S= Socket | 12= 12 point 6= 6 point | 2= 1/4" 3= 3/8" 4= 1/2" 6= 3/4" 8= 1" | H= SAE M= Metric | SAE socket: i.e. 38= 3/8" (from 7/32" to 4-1/2") Metric socket: i.e. 20 (from 4mm to 125mm) Extensions: i.e. 3" (from 2" to 36") | L= Deep U= Universal UL= Universal Deep |

Socket Sets

| S | K | 3 | M | 8 | L |
|------------------|---------------|---|--|--|---|
| Socket Type | Kit | Drive Size | SAE or Metric | Number of pieces per kit | Socket Length |
| S= Socket | K= Kit | 2= 1/4" 3= 3/8" 4= 1/2" 34= Combo 3/8" & 1/2" 6= 3/4" 8= 1" | H= SAE M= Metric C= Combo SAE & Metric | 3= 3 pieces 4= 4 pieces 5= 5 pieces 7= 7 pieces 8= 8 pieces 9= 9 pieces 10= 10 pieces 13= 13 pieces 14= 14 pieces 86= 86 pieces | L= Deep F= Flip U= Universal |

Industrial-grade Impact Sockets

Backed by a proud heritage of reliability and innovation, Ingersoll Rand introduces a comprehensive line of industrial-grade sockets consistent with the quality of our best-in-class Impactools.

Features and Benefits

| Features | Benefits |
|---------------------------------|--|
| A Impact-grade toughness | Designed for high-torque applications |
| B Chrome-molybdenum steel | Forged for high-strength durability |
| C Laser-etched size labeling | Enables easier identification to get the job done faster |
| D Electro-phosphate finish | Projects a sleeker look for higher visibility |
| E Backed by a lifetime warranty | Provides peace of mind with proven reliability |

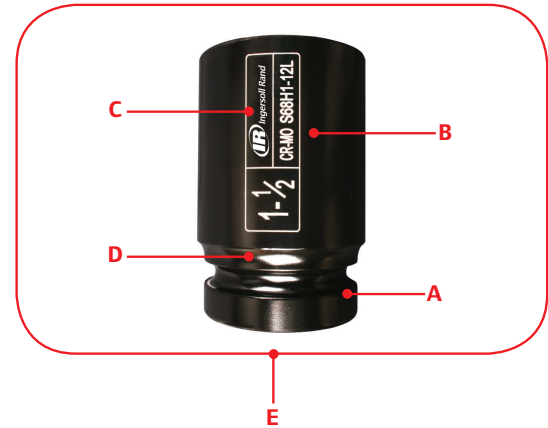

1/4" Square Drive Sockets

Sets

| Part Number | Pieces | Description | Contents |
|-------------|--------|---|---|
| SK2C10 | 10 | 1/4" drive combo SAE and metric standard socket set | 3/16", 1/4", 3/8", 1/2", 9/16", 4 mm, 6 mm, 10 mm, 12 mm, 14 mm |
| SK2M12 | 12 | 1/4" drive metric standard socket set | 6 mm, 7 mm, 8 mm, 9 mm, 10 mm, 11 mm, 12 mm, 13 mm, 14 mm, 50 mm extension, 10 mm extension, 3/8" F to 1/4" M adapter |



SK2C10



SK2M12

Adapters

| Part Number | Output Drive Size | Description |
|-------------|-------------------|------------------|
| A2F3M | 3/8" | 1/4" F to 3/8" M |
| J2 | 1/4" | Universal joint |



Extensions

| Part Number | Output Drive Size | Description |
|-------------|-------------------|--------------|
| E22H | 1/4" | 2" extension |
| E24H | 1/4" | 4" extension |
| E26H | 1/4" | 6" extension |



Ask your Ingersoll Rand representative or refer to catalog IRITS-1210-087 for our full line of industrial grade sockets.

3/8" Square Drive Sockets

Sets

| Part Number | Pieces | Description | Contents |
|-------------|--------|---|---|
| SK3H8 | 8 | 3/8" drive SAE standard socket set | 5/16", 3/8", 7/16", 1/2", 9/16", 5/8", 11/16", 3/4" |
| SK3H8L | 8 | 3/8" drive SAE deep socket set | 5/16", 3/8", 7/16", 1/2", 9/16", 5/8", 11/16", 3/4" |
| SK3H7U | 7 | 3/8" drive SAE universal socket set | 3/8", 7/16", 1/2", 9/16", 5/8", 11/16", 3/4" |
| SK3M8 | 8 | 3/8" drive metric standard socket set | 9 mm, 10 mm, 11 mm, 13 mm, 14 mm, 15 mm, 17 mm, 19 mm |
| SK3M8L | 8 | 3/8" drive metric deep socket set | 9 mm, 10 mm, 11 mm, 13 mm, 14 mm, 15 mm, 17 mm, 19 mm |
| SK3M10 | 10 | 3/8" drive metric standard socket set | 9 mm, 10 mm, 11 mm, 12 mm, 13 mm, 14 mm, 15 mm, 16 mm, 17 mm, 19 mm |
| SK3M7U | 7 | 3/8" drive metric universal socket set | 10 mm, 12 mm, 13 mm, 14 mm, 15 mm, 17 mm, 19 mm |
| SK3C8 | 8 | 3/8" drive combo SAE and metric standard socket set | 3/8", 1/2", 5/8", 11/16", 10 mm, 13 mm, 16 mm, 17 mm |



Adapters

| Part Number | Output Drive Size | Description |
|-------------|-------------------|------------------|
| A3F2M | 1/4" | 3/8" F to 1/4" M |
| A3F4M | 1/2" | 3/8" F to 1/2" M |
| J3 | 3/8" | Universal joint |



Extensions

| Part Number | Output Drive Size | Description |
|-------------|-------------------|---------------|
| E33H | 3/8" | 3" extension |
| E36H | 3/8" | 6" extension |
| E312H | 3/8" | 12" extension |



1/2" Square Drive Sockets

Sets

| Part Number | Pieces | Description | Contents |
|-------------|--------|--|---|
| SK4H13 | 13 | 1/2" drive SAE standard socket set | 7/16", 1/2", 9/16", 5/8", 11/16", 3/4", 13/16", 7/8", 15/16", 1", 1-1/16", 1-1/8", 1-1/4" |
| SK4H13L | 13 | 1/2" drive SAE deep socket set | 7/16", 1/2", 9/16", 5/8", 11/16", 3/4", 13/16", 7/8", 15/16", 1", 1-1/16", 1-1/8", 1-1/4" |
| SK4H7U | 7 | 1/2" drive SAE universal socket set | 1/2", 9/16", 5/8", 11/16", 3/4", 13/16", 7/8" |
| SK4M14 | 14 | 1/2" drive metric standard socket set | 10 mm, 11 mm, 12 mm, 13 mm, 14 mm, 15 mm, 16 mm, 17 mm, 18 mm, 19 mm, 21 mm, 22 mm, 26 mm, 27 mm |
| SK4M14L | 14 | 1/2" drive metric deep socket set | 10 mm, 11 mm, 12 mm, 13 mm, 14 mm, 15 mm, 16 mm, 17 mm, 18 mm, 19 mm, 21 mm, 22 mm, 26 mm, 27 mm |
| SK4M4L | 4 | 1/2" drive metric deep axle nut service socket set | 30 mm, 32 mm, 34 mm, 36 mm |
| SK4M7U | 7 | 1/2" drive metric universal socket set | 13 mm, 14 mm, 15 mm, 17 mm, 19 mm, 21 mm, 22 mm |
| SK4C3F | 3 | 1/2" drive lug nut service flip socket set | 3/4", 13/16", 19 mm x 21 mm, 3" extension |
| SK34C86 | 86 | 3/8" and 1/2" drive combo standard and deep socket set | Includes all sockets in SK3H8, SK3H8L, SK3M8, SK3M8L, SK4H13, SK4H13L, SK4M14, and SK4M14L |
| SK4M5L | 5 | 1/2" drive deep socket set | 17 mm, 19 mm, 21 mm, 22 mm, 24 mm |
| SK4M3L | 3 | 1/2" drive metric deep protective socket set | 17 mm, 19 mm, 21 mm |
| SK4M18 | 18 | 1/2" drive metric socket set | Standard: 10 mm, 11 mm, 13 mm, 14 mm, 17 mm, 19 mm, 21 mm, 22 mm, 24 mm Deep: 13 mm, 14 mm, 21 mm, 24 mm Deep Thin Wall: 17 mm, 19 mm, 21 mm, 125 mm extension, universal joint |
| SK4LNR | 8 | 1/2" drive metric lug nut removal set | 17 mm, 18.5 mm, 20 mm, 21.5 mm, 23 mm, 24.5 mm, 26 mm, 27.5 mm |



SK4H13



SK4M14L



SK34C86



SK4M14



SK4H13L



SK4H7U



SK4M7U



SK4C3F



SK4M4L

Adapters

| Part Number | Output Drive Size | Description |
|-------------|-------------------|------------------|
| A4F3M | 3/4" | 1/2" F to 3/8" M |
| A4F6M | 3/4" | 1/2" F to 3/4" M |
| J4 | 1/2" | Universal joint |



Extensions

| Part Number | Output Drive Size | Description |
|-------------|-------------------|--------------------------|
| E43H | 1/2" | 3" extension |
| E45H | 1/2" | 5" extension |
| E47H | 1/2" | 7" extension |
| E410H | 1/2" | 10" extension |
| E418H | 1/2" | 18" extra-long extension |
| E424H | 1/2" | 24" extra-long extension |
| E436H | 1/2" | 36" extra-long extension |



3/4" Square Drive Sockets

Sets

| Part Number | Pieces | Description | Contents |
|-------------|--------|------------------------------------|---|
| SK6H8 | 8 | 3/4" drive SAE standard socket set | 1", 1-1/16", 1-1/8", 1-1/4", 1-5/16", 1-3/8", 1-7/16", 1-1/2" |
| SK6H8L | 8 | 3/4" drive SAE deep socket set | 1", 1-1/16", 1-1/8", 1-1/4", 1-5/16", 1-3/8", 1-7/16", 1-1/2" |
| SK6M6L | 6 | 3/4" drive metric deep socket set | 24 mm, 27 mm, 30 mm, 32 mm, 33 mm, 36 mm |



SK6H8



SK6H8L



SK6M6L

Adapters

| Part Number | Output Drive Size | Description |
|-------------|-------------------|-----------------------|
| A6F4M | 1/2" | 3/4" F to 1/2" M |
| A6F8M | 1" | 3/4" F to 1" M |
| A6FS5M | #5 spline | 3/4" F to #5 spline M |
| J6 | 3/4" | Universal joint |



Extensions

| Part Number | Output Drive Size | Description |
|-------------|-------------------|--------------------------|
| E63H | 3/4" | 3" extension |
| E67H | 3/4" | 7" extension |
| E610H | 3/4" | 10" extension |
| E613H | 3/4" | 13" extra-long extension |



1" Square Drive Sockets

Sets

| Part Number | Pieces | Description | Contents |
|-------------|--------|---|--|
| SK8H8 | 8 | 1" drive SAE standard socket set | 7/8", 15/16", 1", 1-1/16", 1-1/8", 1-3/16", 1-1/4", 1-1/2" |
| SK8H8L | 8 | 1" drive SAE deep socket set | 7/8", 15/16", 1", 1-1/16", 1-1/8", 1-3/16", 1-1/4", 1-1/2" |
| SK8H9T | 9 | 1" drive SAE truck service socket set | 13/16" square; 7/8", 15/16", 1", 1-3/16", 1-1/2" hex; 1-1/16", 1-1/8", 1-1/4" deep thin wall hex |
| SK8C5T | 5 | 1" drive combo SAE and metric deep truck service socket set | 13/16" square; 33 mm & 1-1/2" deep hex; 1-1/8" and 1-1/4" deep thin wall hex |
| SK8M4L | 4 | 1" drive metric deep socket set | 27 mm, 30 mm, 32 mm, 33 mm |



SK8H8



SK8H8L



SK8H9T



SK8C5T



SK8M4L

Adapters

| Part Number | Output Drive Size | Description |
|-------------|-------------------|---------------------|
| A8F6M | 3/4" | 1" F to 3/4" M |
| A8F12M | 1-1/2" | 1" F to 1-1/2" M |
| A8FS5M | #5 spline | 1" F to #5 spline M |
| J8 | 1" | Universal joint |



Extensions

| Part Number | Output Drive Size | Description |
|-------------|-------------------|--------------------------|
| E83H | 1" | 3" extension |
| E87H | 1" | 7" extension |
| E810H | 1" | 10" extension |
| E813H | 1" | 13" extra-long extension |



Air Grinders and Cutting Tools



With high-strength steels, advanced plastics, and new composite materials in today's cars and trucks, you need versatile tools for precise, controlled cutting. Ingersoll Rand cutting tools are the reliable choice of auto body and repair shops, used for everything from muffler and exhaust work to sunroof installations and body repairs.

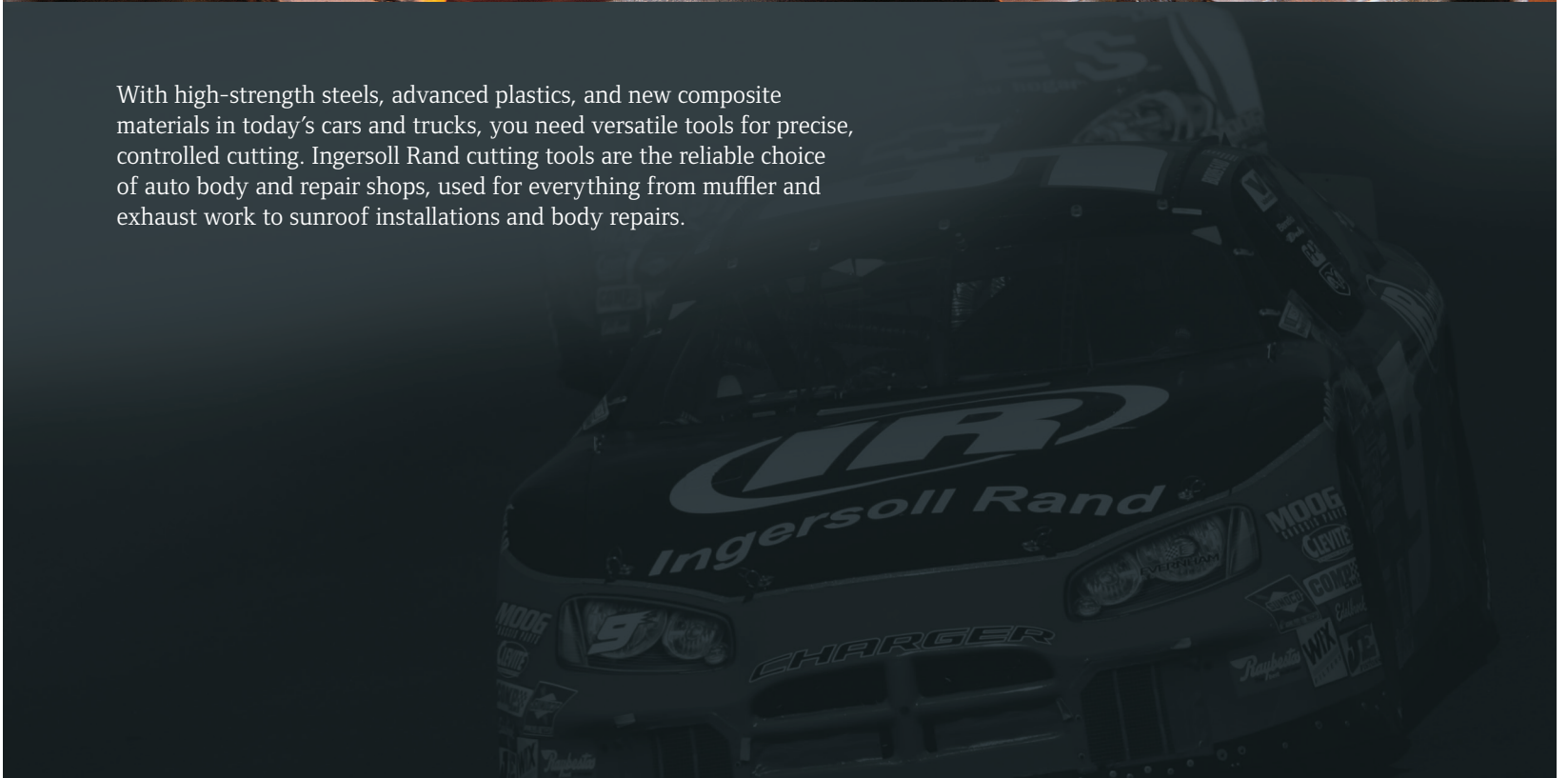

Air Grinders

| Model | Rated Power hp (kW) | Free Speed rpm | Output | Weight lb (kg) | Length in (mm) | Air Consumption cfm (L/min) | Average Air Consumption @ Load cfm (L/min) | Sound Pressure / Power dBA | Air Inlet NPTF in | Min Hose Size in (mm) |
|-------|------------------------|-------------------|-------------|-------------------|-------------------|--------------------------------|--|-------------------------------|-------------------------|--------------------------|
| 301 | 0.25 (0.19) | 21,000 | 1/4" Collet | 0.99 (0.45) | 5.0" (127) | 6 (170) | 25 (707) | 91.8 / 104.8 | 1/4" | 3/8" (10) |
| 302A | 0.25 (0.19) | 18,000 | 1/4" Collet | 0.97 (0.44) | 5.0" (127) | 3 (85) | 12 (340) | 94 / 105 | 1/4" | 3/8" (10) |
| 307A | 0.25 (0.19) | 28,000 | 1/4" Collet | 0.69 (0.31) | 4.8" (121) | 6 (170) | 25 (707) | 83 / 94 | 1/4" | 3/8" (10) |
| 308A | 0.5 (0.37) | 25,000 | 1/4" Collet | 1.16 (0.53) | 5.6" (143) | 3 (85) | 20 (566) | 91 / 102 | 1/4" | 3/8" (10) |

301

Multi-purpose Air Angle Die Grinder

Part of an expanded line of economical, heavy-duty grinders, the 301 packs valuable features into a compact package. Use it for grinding, edge-breaking, deburring, porting, and polishing. Wherever space is tight, its right-angle configuration provides easy access.

- Compact, lightweight, and easy to handle
- Self-locking throttle
- Precision-machined gearing delivers maximum power transfer



302A

Air Angle Die Grinder

When a straight tool isn't practical for working in confined areas, this economical die grinder with a right-angle head is the one to use. It's compact and well-designed for grinding, porting, polishing, deburring, and breaking sharp edges.

- Precision-machined steel gears
- Positive grip 1/4"-capacity collet chuck
- Self-locking throttle lever



307A

Mini Air Die Grinder

The 307A combines performance and versatility in a lightweight, compact package. It can be used with all types of accessories for porting, weld breaking, and smoothing sharp edges, as well as deburring, polishing, and grinding.

- Standard 1/4" collet for all types of accessories
- Safety lever prevents accidental starts
- Front exhaust helps keep work surface clean



308A

Air Die Grinder

A durable yet economical choice offering longer life and higher free speed at 25,000 rpm, this general-purpose tool is designed for porting, light weld grinding, and breaking sharp edges.

- Comes with two collet wrenches
- Self-locking throttle lever
- Positive grip 1/4"-capacity collet chuck



Air Grinders and Cutting Tools

Carbide Grinding Burr Kits



Our carbide burrs set the industry standard for quality, and come in a variety of types, styles, and sizes. See pages 33 and 34 for our complete line of Ingersoll Rand air cutting tools and grinder accessories.

Air Grinders

| Model | Rated Power hp (kW) | Free Speed rpm | Output | Weight lb (kg) | Length in (mm) | Average Air Consumption cfm (L/min) | Air Consumption @ Load cfm (L/min) | Sound Pressure / Power dBA | Air Inlet NPTF in | Min Hose Size in (mm) |
|--------------------------------|------------------------|----------------------|------------------|-------------------|-------------------|---|---|-------------------------------------|----------------------------|-----------------------------|
| 3102 | 0.33 (0.25) | 20,000 | 1/4" Collet | 1.27 (.58) | 6.75" (171) | 3 (85) | 18 (510) | 90 / 101 | 1/4" | 3/8" (10) |
| 3108 | 0.33 (0.25) | 25,000 | 1/4" Collet | 1.27 (.58) | 6.75" (171) | 3 (85) | 18 (510) | 92 / 103 | 1/4" | 3/8" (10) |
| 326 | N/A | 20,000 | N/A | 2.3 (1.04) | 8.88" (226) | 10 (283) | 25 (708) | 94.3 / 107.3 | 1/4" | 3/8" (10) |
| 345MAX*0.88 (0.66) | | 12,000 | 5/8" - 11 Thread | 3.44 (1.56) | 9.6" (244) | 10 (283) | 41 (1,160) | 79.6 / 90.6 | 1/4" | 3/8" (10) |
| 3445MAX0.88 (0.66) | | 12,000 | 5/8" - 11 Thread | 3.37 (1.53) | 9.6" (244) | 10 (283) | 41 (1,160) | 79.6 / 90.6 | 1/4" | 3/8" (10) |
| MINI TOOL SURFACE PREP GRINDER | | | | | | | | | | |
| 3103XP | 0.2 (0.15) | 15,000 | 1/4" - 20 Thread | 0.99 (0.45) | 5" (125) | 2.1 (59) | 19.4 (549) | 84.9 / 95.9 | 1/4" | 3/8" (10) |

*Not pictured.

3102

Composite Die Grinder

For the ultimate performance and versatility in a lightweight package with superior maneuverability, these grinders are the perfect choice. The 3102 features a composite grip for superior ergonomics and comfort. These powerful die grinders can be used in various applications including porting, weld braking, deburring, polishing, grinding, and more.

- 20,000 rpm
- Safety release throttle
- Positive grip 1/4"-capacity collet chuck



3108

Composite Die Grinder

The 3108 features a composite grip for superior ergonomics and comfort. These powerful die grinders can be used in various applications including porting, weld braking, deburring, polishing, grinding, and more.

- 25,000 rpm
- Safety release throttle
- Positive grip 1/4"-capacity collet chuck



3445MAX

Air Angle Grinder

The 3445MAX is the perfect choice for high performance material removal. This 4.5" air angle grinder combines a unique internal governor with a powerful 0.88 hp motor, to give you a best-in-class power to weight ratio grinder that will maximize your rate of material removal. (Also available in 5" 345MAX)

MAX Power 0.88 hp and 12,000 rpm motor delivers the power you need to grind through the toughest job.

MAX Productivity Internal governor maximizes speed under load, increasing your rate of material removal.

MAX Comfort Lower weight and enhanced grip design enables extended usage without fatigue.



326

Cut-off Tool

The heavy-duty cut-off tool is designed for durability and on-the-job performance. Ideal for cutting mufflers, tail pipes, sheet metal, nuts, and bolts.

- Provides 18,000 rpm for fast cutting
- Steel shield deflects debris away from operator
- Large hooked locking throttle lever provides user comfort and safety



3103XP

Mini Surface Prep Sander

Whether you're working in tight spaces or doing finely detailed finish work, our mini tools deliver the power, versatility, and durability you want, in a conveniently smaller size.

- Ball-bearing construction enhances durability and smooth power delivery
- Double-sided, adjustable speed settings provide variability for a broader range of applications
- includes 2" and 3" medium backing pads



Remove rough spots quickly and easily

3103K

Mini Surface Prep Sander Kit

- Includes 14-piece 2" and 3" sanding discs

Abrasive Convenience Packs



In addition to our abrasive convenience packs, Ingersoll Rand offers a line of 2" and 3" surface conditioning discs designed to maximize the productivity of our air grinders while ensuring the best possible finishes. See pages 33 and 34 for our full line of cutting tool and grinder accessories.

Surface Conditioning Kits

301-2MK

Surface Conditioning Kit

Ingersoll Rand has packed the 301 in a strong, blow-molded plastic case along with four coarse and four medium grit 2" Roloc™ surface conditioning pads and a disc holder.



301-32MK

Surface Conditioning Kit

This kit contains the 301 in a strong, blow-molded plastic case along with two coarse and two medium grit 3" Roloc surface conditioning pads, two coarse, two medium grit 2" Roloc surface conditioning pads, and two disc holders.



301-3MK

Surface Conditioning Kit

Four coarse and four medium grit 3" Roloc surface conditioning pads are packed in a strong blow-molded case with our popular 301 grinder.



301-K

Die Grinder Kit

Ingersoll Rand has packed the 301 in a strong, blow-molded plastic case complete with 10 mounted grinding tips.



3102K

Die Grinder Kit

For the ultimate performance and versatility in a lightweight package with superior maneuverability in an angle grinder, the 3102 is the perfect choice. The 3102 features a composite grip for superior ergonomics and comfort. This powerful grinder can be used in a variety of applications, including porting, weld braking, deburring, grinding, polishing, etc. The kit includes the 3102 Grinder, 2" and 3" Quick Change Backing Pads, along with a variety of 2" and 3" Quick Change Sanding Disks, 2" and 3" Quick Change Coarse and Medium Polishing Disks, all packaged in a strong, blow-molded plastic case.



307-K

Die Grinder Kit

The 307-K comes with 10 mounted grinding tips in a strong, blow-molded case.



4102K

Surface Preparation Kit

Along with the versatile, lightweight, and powerful 3102 Angle Grinder, this Kit comes along with the ultimate in Random Orbital Sanders, the 4151-HL. The 4151-HL adds to the Kit the benefit of a lightweight, 6" pad, 12,000 RPM, vacuum-ready, random orbital sander for all of the fine-finish requirements for the job at hand. Along with the Angle Grinder and the Random Orbital Sander, the kit includes a 3" Quick Change Backing Pad, 3" Quick Change Sanding Disks, 3" Quick Change Coarse and Medium Polishing Disks, a 6" Hook and Loop Backing Pad, and 6" Sanding Disks, all packaged in a strong, blow-molded plastic case.



3108K

Die Grinder Kit

The 3108 features a composite grip for superior ergonomics and comfort. These powerful die grinders can be used in various applications including porting, weld braking, deburring, polishing, grinding, and more.



Air Cutting Tools

| Model | Strokes Per Minute | Weight lb (kg) | Length in (mm) | Average Air Consumption cfm (L/min) | Air Consumption @ Load cfm (L/min) | Sound Pressure / Power dBA | Air Inlet NPTF in | Min Hose Size in (mm) |
|--------|--------------------|----------------|----------------|-------------------------------------|------------------------------------|----------------------------|-------------------|-----------------------|
| 7802SA | 4,200 | 2.8 (1.27) | 9.4" (239) | 4 (113) | 21 (595) | N/A | 1/4" | 3/8" (10) |
| 325B | 3,200 | 2.1 (0.95) | 7.3" (185) | 4 (113) | 17 (481) | 90.2 / 103.2 | 1/4" | 3/8" (10) |
| 429 | 10,000 | 1.3 (0.6) | 8.3" (210) | 8 (226) | 9 (255) | 84.3 / 95.3 | 1/4" | 1/4" (6) |
| 4429* | 5,750 | 1.6 (0.74) | 9.3" (235) | 4 (113) | 7.6 (215) | 66.2 / 77.2 | 1/4" | 1/4" (6) |

*Not pictured.

7802SA

Air Shear

This versatile cutting shear that makes clean cuts in cold-rolled steel up to 20-gauge without chips is ideal for body shops, sheet metal shops, air-conditioning fabricators, plastic fabricators, heating contractors, and machine shops.

- Cuts squares, angles, and circles
- Long-life tool with heavy-duty cutting blades
- Shears most types of plastics and all types of aluminum, tin, and steel



325B

Air Nibbler

Get a bigger bite and better angle cuts with our Air Nibbler. Instead of shearing or sawing, the tool actually "nibbles" cold-rolled steel, plastic, tin, aluminum, and other metals, up to 18-gauge thicknesses at a rate of more than 6' per minute. It's ideal for paint and auto body shops, tinsmiths, and sheet metal shops.

- Cuts out quarter panels without distorting the edges of the material
- Starts cuts in the center of a panel
- Holds a tight 1/4" radius with great accuracy



429

Air Reciprocating Saw

The 429 is a versatile air saw for cutting intricate shapes and light radius curves in all types of plastics, fiberglass, and composite materials, as well as aluminum and sheet metal. This reduced vibration tool is excellent for body shop repair, muffler and exhaust work, and sunroof installations.

- Comes with 6 high-speed steel cutting blades and 2 hex wrenches
- Cuts flat and curved surfaces
- Durable, long-life tool



Saw Blades



Saw blades, cutting tools, and all other grinder accessories can be found on pages 33 and 34.

Carbide Grinding Burr Kits

Ingersoll Rand carbide burrs are titanium nitride (TiN) coated to provide maximum edge retention and corrosion resistance. The TiN coating can improve the average lifetime of the burr by more than three times.

Note: Burrs have a maximum operating speed of 40,000 rpm.



1814TiN



1438TiN



M30TiN

The 30 piece, carbide burr mega set covers a wide range of applications. Handy storage box keeps burrs organized and ready for use.

Air Grinders and
Cutting Tools

| Part Number | | Description |
|-------------|--------------------------------|--|
| 1814TiN | 6-piece carbide burr kit | TiN coated carbide burrs — 1/8" shank, 1/4" head diameter with soft-sided case |
| 618TiN | 6-piece carbide burr kit | TiN coated carbide burrs — 1/8" shank, 1/4" and 1/8" head diameters with soft-sided case |
| 1818TiN | 6-piece carbide burr kit | TiN coated carbide burrs — 1/8" shank, 1/8" head diameter with soft-sided case |
| 1816TiN | 6-piece carbide burr kit | TiN coated carbide burrs — 1/8" shank, various head diameters with soft-sided case |
| 1438TiN | 6-piece carbide burr kit | TiN coated carbide burrs — 1/4" shank, 3/8" head diameter with soft-sided case |
| 614TiN | 6-piece carbide burr kit | TiN coated carbide burrs — 1/4" shank, 1/2" and 3/8" head diameters with soft-sided case |
| 1412TiN | 6-piece carbide burr kit | TiN coated carbide burrs — 1/4" shank, 1/2" head diameter with soft-sided case |
| 814TiN | 8-piece carbide burr kit | TiN coated carbide burrs — 1/4" shank, 1/2" and 3/8" head diameters with hard case |
| M30TiN | 30-piece carbide burr mega set | TiN coated carbide burrs — 1/4" and 1/2" shank, various head diameters and shapes with hard case |

Abrasive Convenience Packs

| Part Number | Description |
|---|--|
| SANDING VARIETY GRIT PACKS | |
| 02A-VARAO-6 | 2" AO Series sanding discs — 2 each 36, 50, 80 grit |
| 03A-VARAO-6 | 3" AO Series sanding discs — 2 each 36, 50, 80 grit |
| 02A-VARCO-6 | 2" CO Series sanding discs — 2 each 36, 50, 80 grit |
| 03A-VARCO-6 | 3" CO Series sanding discs — 2 each 36, 50, 80 grit |
| 23A-VARAO-6 | 2" and 3" AO Series sanding discs — 1 each 36, 50, 80 grit |
| SURFACE CONDITIONING / VARIETY GRIT PACKS | |
| 02A-VARBR-5 | 2" surface preparation discs — 2 each coarse and medium, 1 very fine |
| 03A-VARBR-5 | 3" surface preparation discs — 2 each coarse and medium, 1 very fine |
| 23A-VARBR-6 | 2" and 3" surface preparation discs — 1 each coarse, medium, 1 very fine |
| HIGH STRENGTH — BLENDING AND BUFFING DISCS | |
| 02A-MEDHS-4 | 2" medium-grade, blending kit 3 discs with backing pad and post |
| 03A-MEDHS-4 | 3" medium-grade, blending kit 3 discs with backing pad and post |
| QUICK STRIP — PAINT AND CORROSION DISCS | |
| 02A-CRSBS-4 | 2" coarse quick-strip kit 3 discs with backing pad and post |
| 03A-CRSBS-4 | 3" coarse quick-strip kit 3 discs with backing pad and post |
| COMPLETE SURFACE CONDITIONING KITS | |
| 02A-VAR-KIT | 2" complete surface preparation kit with backing pad and post |
| 03A-VAR-KIT | 3" complete surface preparation kit with backing pad and post |



Cut-off Wheels

| Part Number | Description |
|-------------|-------------------------------------|
| 9520 | 3" diameter cutting discs (5 pack) |
| 9521 | 3" diameter cutting discs (50 pack) |



Bi-metal Reciprocating Saw Blades

These Bi-metal technology blades are created using a solid-state diffusion process that applies high-speed steel to both edges of the backing material, which increases the contact area by 170 percent. Bi-metal blades have a new tooth profile that generates more (but smaller) chips: this reduces frictional heat that is generated during the cutting application, which will enhance overall performance.

| Part Number | Description | Teeth Per Inch | Quantity |
|---------------------|-----------------------------|----------------|----------|
| FINE | | | |
| P4FS-6 | Fine standard pitch | 32 | 6 |
| P4FS-20 | Fine standard pitch | 32 | 20 |
| P4FS-50 | Fine standard pitch | 32 | 50 |
| COARSE | | | |
| P4CS-6 | Coarse standard pitch | 24 | 6 |
| P4CS-20 | Coarse standard pitch | 24 | 20 |
| P4CS-50 | Coarse standard pitch | 24 | 50 |
| EXTRA COARSE | | | |
| P4EV-6 | Extra-coarse variable pitch | 14 – 18 | 6 |
| P4EV-20 | Extra-coarse variable pitch | 14 – 18 | 20 |
| P4EV-50 | Extra-coarse variable pitch | 14 – 18 | 50 |



Air Finishing Tools



Ingersoll Rand has the industry's most complete line of air finishing tools. Sanders, polishers, and buffers come in a variety of models from traditional styles for heavy material removal to the newest models for excellent control and brilliant surfaces. All Ingersoll Rand finishing tools are designed for long-life and swirl-free finishes.

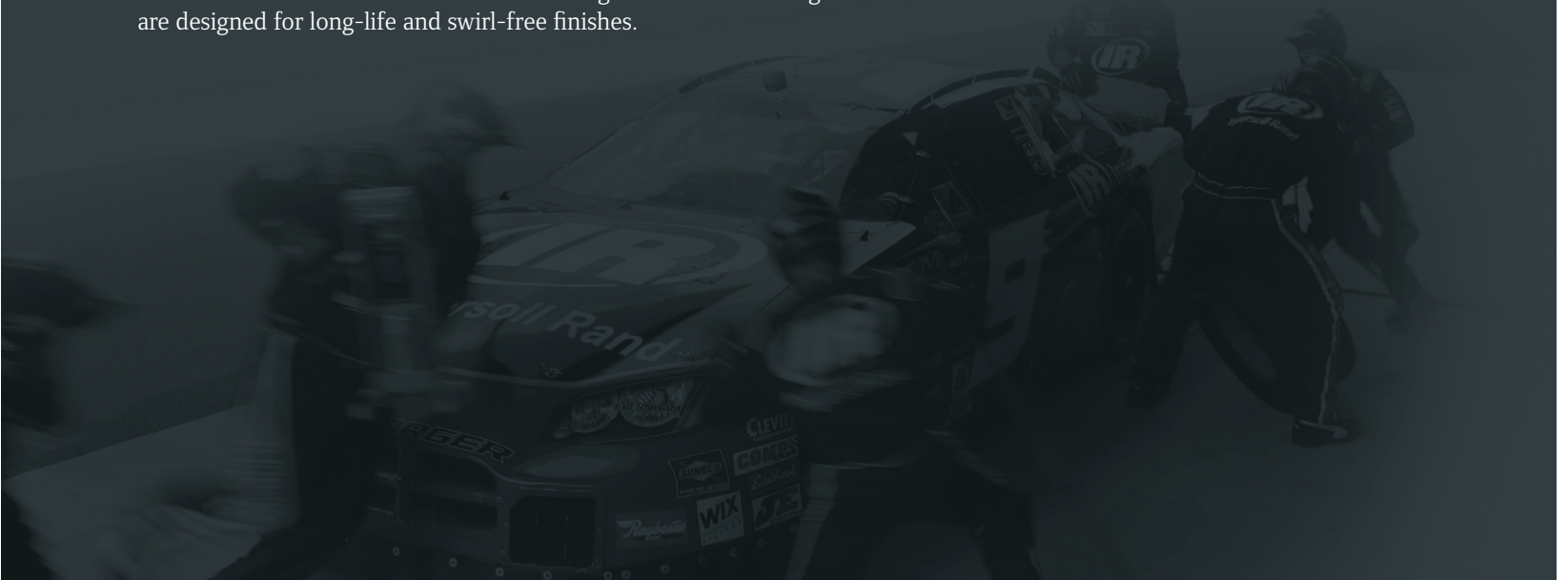

Air Finishing Tools

| Model | Free Speed rpm | Rated Power hp (kW) | Pad Size in (mm) | Weight lb (kg) | Average Air Consumption cfm (L/min) | Air Consumption @ Load cfm (L/min) | Sound Pressure / Power dBA | Chuck Size in (mm) | Air Inlet NPTF in | Min Hose Size in (mm) |
|-------|----------------|---------------------|--------------------------------|----------------|-------------------------------------|------------------------------------|----------------------------|--------------------|-------------------|-----------------------|
| 327* | 22,000 | 0.5 (0.38) | N/A | 1.6 (.73) | 15 (425) | 28 (793) | 90.9 / 103.9 | 3/8" (10) | 1/4" | 3/8" (10) |
| 327LS | 3,000 | 0.5 (0.37) | N/A | 1.13 (.51) | 14 (396) | 27 (765) | 95 / 108 | 3/8" (10) | 1/4" | 3/8" (10) |
| 312A | 8,000 | 0.3 (0.22) | 3-2/3" x 6-3/4" (93 x 171)*** | 4.6 (2.09) | 9 (255) | 12 (340) | 94.1 / 107.1 | N/A | 1/4" | 3/8" (10) |
| 317A | 18,000 | N/A | 5" (127) | 2.3 (1.04) | 12 (340) | 25 (708) | 86.7 / 99.7 | N/A | 1/4" | 3/8" (10) |
| 315 | 3,000** | N/A | 2-3/4" x 17-1/2" (70 x 445)*** | 6.6 (2.99) | 8 (226) | 9 (255) | 93.3 / 106.3 | N/A | 1/4" | 3/8" (10) |

*Not pictured. **1" length strokes per minute. ***Rectangular pad size.

327LS

Low-speed Air Tire Buffer

Designed for convenience, the many features of the 327LS make it an ideal tool for every tire shop. The quick-change chuck, built-in regulator, and lever-style throttle make patchwork, roughing areas for recapping, and cleaning tire moldings a breeze.

- Trigger design with lock-off feature allows for easy operation and protection from accidental start-up
- Piped-away exhaust (included) directs air away from work area and operator
- Convenient hanger keeps tool within easy reach



312A

Orbital Air Sander 3-2/3" x 6-3/4" Pad

The 312A air orbital sander has a free speed up to 8,000 rpm to make fast work of smoothing fiberglass, wood, and body filler, and to take care of any sanding job on paint, metal, and fiberglass. Plus, you can run the 312A with one hand, using the compact, contoured palm-grip.

- Balanced ball bearing construction
- Automatic release throttle lever with positive stop action
- Built-in regulator for positive speed control



317A

High-speed Air Sander 5" Pad

For small jobs and hard-to-reach places, the 317A is an economical high-speed sander ideal for light sanding, feather edging, and rust removal.

- Easy to handle, compact, and lightweight
- Built-in power regulator
- Comes with two backing pads; one is 3", and the other is 5" (stackable)



315

Twin-piston Straight-line Air Sander 2-3/4" x 17-1/2" Pad

The twin-piston design keeps extra power in reserve to prevent stalling and tackle sanding jobs like smoothing down body filler or shaping and leveling large, flat surfaces.

- 3,000 reciprocating strokes per minute
- Quick-action paper clamps
- Smooth, reliable power



Straight-line Sanding Pads



Constructed with non-metallic material to reduce side strap wear, our straight-line sanding pads are designed specifically for the Ingersoll Rand 315 straight-line sander. See pages 40 for our full line of finishing tool accessories.

| Model | Free Speed rpm | Rated Power hp (kW) | Pad Diameter in (mm) | Weight lb (kg) | Output | Average Air Consumption cfm (L/min) | Air Consumption @ Load cfm (L/min) | Sound Pressure / Power dBA | Air Inlet NPTF in | Min Hose Size in (mm) |
|--------------------------|----------------|---------------------|----------------------|----------------|-------------------|-------------------------------------|------------------------------------|----------------------------|-------------------|-----------------------|
| 311A | 12,000 | 0.25 (0.191) | 6" (150) | 4.2 (1.91) | 5/16" – 24 Thread | 4 (113) | 17 (481) | 85.6 / 98.6 | 1/4" | 3/8" (10) |
| 328B | 825 | 0.25 (0.191) | 8" (203) | 4.7 (2.13) | N/A | 4 (113) | 16 (453) | 90.45 / 93.7 | 1/4" | 3/8" (10) |
| 313A | 5,000 | 0.5 (0.37) | 7" (175) | 4.5 (2.04) | 5/8" – 11 Thread | 8 (226) | 29 (651) | 99.3 / 112.3 | 1/4" | 3/8" (10) |
| 314A* | 2,500 | 0.4 (0.30) | 7" (175) | 4.5 (2.04) | 5/8" – 11 Thread | 8 (226) | 29 (623) | 97.3 / 110.3 | 1/4" | 3/8" (10) |
| 318A | 2,800 | 1 (0.746) | 7" (175) | 4.5 (2.04) | 5/8" – 11 Thread | 6 (170) | 21 (595) | 90.5 / 103.5 | 1/4" | 3/8" (10) |
| 319A* | 5,000 | N/A | 7" (175) | 4.5 (2.04) | 5/8" – 11 Thread | 6 (170) | 20 (566) | 90.8 / 103.8 | 1/4" | 3/8" (10) |
| MINI AIR FINISHING TOOLS | | | | | | | | | | |
| 3128XP | 15,000 | 0.2 (0.15) | 3" (76.2) | 1.1 (0.5) | 1/4" – 20 Thread | 2.1 (58) | 14.7 (416) | 84.2 / 96.9 | 1/4" | 3/8" (10) |
| 3129XP | 6,000 | 0.3 (0.22) | 3" (76.2) | 1.3 (0.6) | 1/4" – 20 Thread | 2.2 (62) | 19.9 (561) | 83.5 / 94.5 | 1/4" | 3/8" (10) |

* 314A air angle polisher / buffer and 319A sander not pictured.

311A

Dual-action Quiet Air Sander — 6" Pad

A built-in silencer muffles noise as you work with this economical dual-action sander. It's a quality sander used for feather edging, metal preparation, and finish work on body filler. And its dual-action pad motion produces swirl-free finishes.

- Low vibration
- Balanced ball bearing construction
- Adjustable built-in regulator for positive speed control



328B

Gear-driven Orbital Air Sander — 8" Pad

The smooth strength and power of this air-gear-driven orbital sander lets you remove heavy material and body filler on large, flat surfaces leaving a clean, swirl-free finish.

- Dual-action pad motion (5/32" orbit)
- Long-life, low-vibration performance
- Balanced ball bearing construction



313A

Angle Air Sander — 7" Pad

With up to 5,000 rpm free speed, you can work faster on light and heavy sanding jobs, including roughing body filler, removing rust, and smoothing welds.

- Heavy-duty motor handles tough jobs
- Lightweight, only 4.5 lb
- Ball bearing construction for long life



318A

Vertical Air Polisher / Buffer — 7" Pad

Buff and polish all painted surfaces easily. This compact, lightweight vertical polisher / buffer gives you the results you want. The variable speed control lever throttle helps eliminate paint burning. Comes complete with a 7" backing pad.

- Long tool life from the planetary gear reduction feature
- Plenty of power from the 1 hp motor
- Handle exhaust directs air away from work area



3128XP

Mini Random Orbital Sander

- Delivers swirl-free finishes when feather edging, removing rust, preparing metal surfaces, or smoothing welds
- Durable ball-bearing construction ensures smooth power delivery
- Includes 3" hook and loop style backing pad



Sands smoothly, leaving no swirl marks behind

3129XP

Mini Polisher

- Free speed of 6,000 rpm delivers the same performance of polishers twice the size
- Double-sided, adjustable speed settings provide variability for a broader range of applications
- Includes 3" hook and loop style backing pad



Ideal for a smooth, professional finish

3128K

Mini Random Orbital Sander Kit

- Includes 71-piece hook and loop discs

3129K

Mini Polisher Kit

- Includes 4-piece hook and loop pads

Air Finishing Tools

| Model | Free Speed rpm | Rated Power hp (kW) | Pad Diameter in (mm) | Orbit Diameter in (mm) | Weight lb (kg) | Average Air Consumption cfm (L/min) | Air Consumption @ Load cfm (L/min) | Sound Pressure / Power dBA | Air Inlet NPTF in | Min Hose Size in (mm) |
|----------|----------------|---------------------|----------------------|------------------------|----------------|-------------------------------------|------------------------------------|----------------------------|-------------------|-----------------------|
| 4151 | 12,000 | 0.2 (0.15) | 6" (150) | 3/16" (5) | 1.92 (.87) | 8 (226) | 15.5 (439) | 81.6 / 91 | 1/4" | 5/16" (8) |
| 4151-5* | 12,000 | 0.2 (0.15) | 5" (125) | 3/16" (5) | 1.92 (.87) | 8 (226) | 15.5 (439) | 81.6 / 91 | 1/4" | 5/16" (8) |
| 4151-HL* | 12,000 | 0.2 (0.15) | 6" (150) | 3/16" (5) | 1.92 (.87) | 8 (226) | 15.5 (439) | 81.6 / 91 | 1/4" | 5/16" (8) |
| 4151-2* | 12,000 | 0.2 (0.15) | 6" (150) | 3/16" (5) | 2.4 (1.1) | 8 (226) | 15.5 (439) | 81.6 / 91 | 1/4" | 5/16" (8) |
| 4152 | 12,000 | 0.2 (0.15) | 6" (150) | 3/32" (2.5) | 1.92 (.87) | 8 (226) | 15.5 (439) | 81.6 / 91 | 1/4" | 5/16" (8) |
| 4152-HL* | 12,000 | 0.2 (0.15) | 6" (150) | 3/32" (2.5) | 1.92 (.87) | 8 (226) | 15.5 (439) | 81.6 / 91 | 1/4" | 5/16" (8) |

*Not pictured.

NOTE: HL models include a hook-and-loop pad.

4151

Vacuum-ready Random Orbital Air Sander

This vacuum-ready, low-vibration model produces an ultra high-quality finish and connects easily to central or portable vacuum systems. The 4151 extracts dust and particles through and around the pad, keeping foreign matter away from the motor. The vacuum sanding pad features a unique design with large 1/2" holes for efficient operation. Virtually all dust is instantly channeled away from the work.

- 12,000 rpm free speed for swirl-free finishes
- Durable, lightweight composite design weighs less than 2 lb
- 3/16" orbit diameter



4152

Vacuum-ready Random Orbital Air Sander

The 4152 sets a new standard in elite automotive finish work. This fine 3/32" orbit sander helps users achieve high-quality paint finishes. The 4152 utilizes a precision ground counterbalance to reduce vibration.

- 12,000 rpm free speed for swirl-free finishes
- Durable, lightweight composite design weighs less than 2 lb
- 3/32" orbit diameter



Vacuum Kits



Keep your work surface and area clean with our Jet-Vac dust extraction system and accessories. See page 39 for more information. Turn to page 40 for all other major components and accessories.

Vacuum Kits and Accessories

Influenced by jet engine technology, the Ingersoll Rand Jet-Vac dust extraction system sucks up more air than it takes to actually run the tool. Perfect for use with our sanders.

| Part Number | Description | For Use With |
|--------------------------------|---------------------------|---|
| JET-VAC CONVERSION KITS | | |
| 4151JV | Jet-Vac conversion kit | 4151, 4152 Series, Cyclone Standard, Cyclone Select, CycloVAC sanders |
| RSVK-5* | 5" Jet-Vac conversion kit | 4151, 4152 Series, Cyclone Standard, Cyclone Select, CycloVAC sanders |
| RSVK-6* | 6" Jet-Vac conversion kit | 4151, 4152 Series, Cyclone Standard, Cyclone Select, CycloVAC sanders |

*Not pictured.

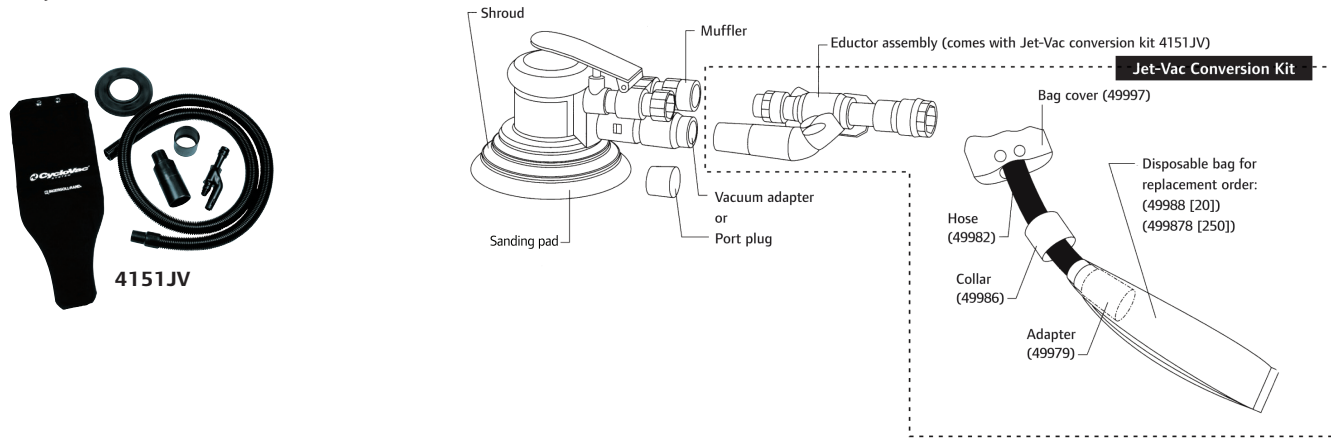

| Part Number | Description | For Use With |
|----------------------------|--|---|
| JET-VAC ACCESSORIES | | |
| 49600* | 6' (1.8 m) hose equipped with molded 1" ID cuffs at each end | 4151, 4152 Series, Cyclone Standard, Cyclone Select, CycloVAC sanders |
| 49973 | Disposable vacuum bag (single) | 4151, 4152 Series, Cyclone Standard, Cyclone Select, CycloVAC sanders |
| 49997 | Bag cover | 4151, 4152 Series, Cyclone Standard, Cyclone Select, CycloVAC sanders |
| 355-402* | Dust collection bag | 4151, 4152 Series, Cyclone Standard, Cyclone Select, CycloVAC sanders |
| 49979 | Vacuum adapter | 4151, 4152 Series, Cyclone Standard, Cyclone Select, CycloVAC sanders |
| 49982 | Vacuum hose | 4151, 4152 Series, Cyclone Standard, Cyclone Select, CycloVAC sanders |
| 49986* | Vacuum hose collar | 4151, 4152 Series, Cyclone Standard, Cyclone Select, CycloVAC sanders |
| 49987* | Disposable vacuum bags (250 pack) | 4151, 4152 Series, Cyclone Standard, Cyclone Select, CycloVAC sanders |
| 49988* | Disposable vacuum bags (20 pack) | 4151, 4152 Series, Cyclone Standard, Cyclone Select, CycloVAC sanders |

*Not pictured.



Air Finishing Tools

4100 Series Major Components and Accessories

| Model | Description |
|---|--|
| NON-VACUUM PADS 3/8" | |
| 49879-1 | 6" vinyl |
| 49094-1 | 5" vinyl |
| 49877-1 | 5" duck |
| VACUUM PADS 3/8" | |
| VPAD-6 | 6" petal pattern |
| 49694 | 6" hook-and-loop |
| 49096-1 | 5" petal pattern |
| VACUUM ADAPTER FOR MODEL 3154 | |
| 4151-A809A-25 | Vacuum adapter |
| SHROUDS | |
| 48266-1 | Short (standard on 4151) |
| 48878 | Long |
| JET-VAC VACUUM BAGS | |
| 49988 | Disposable bags (20 pack) |
| 49987 | Disposable bags (250 pack) |
| JET-VAC CONVERSION KIT | |
| 4151JV | 6" pad 48878 - (1) 6" shroud 49976 - (1) eductor assembly 49973 - (3) disposable bags 49979 - (1) bag adapter 49997 - (1) cloth bag cover 49982 - (1) hose 49986 - (1) collar |
| SERVICE KIT (FOR PREVENTIVE MAINTENANCE) | |
| 30131-2 | IR49837 pad wrench (included with every tool) |
| SPANNER WRENCH | |
| 44548 | Use to remove the lock ring securing the motor assembly |

| Model | Diameter | Description |
|--|----------|---|
| BACKING PADS FOR MODELS 313, 314, 318, 319 | | |
| 313A-825-7 | 7" | Standard-duty - rigid backing pad |
| 6130A | 7" | Heavy-duty - flexible backing pad |
| DUAL-ACTION BACKING PADS FOR MODELS 310 AND 311 | | |
| 311A-825-6 | 6" | Standard-duty - vinyl pad |
| 6120A | 6" | Heavy-duty - firm edge for firm support, cloth back |
| 6121A | 6" | Heavy-duty - soft edge for medium support, cloth back |
| 6122A | 5" | Heavy-duty - firm edge for firm support, cloth back |
| 6123A | 5" | Heavy-duty - soft edge for medium support, cloth back |
| DUAL-ACTION BACKING PAD FOR MODEL 328 | | |
| 328B-825-8 | 8" | Standard-duty - pad assembly |
| POLISHING PAD FOR MODELS 314, 318, OR ANY POLISHER WITH A 5/8"-11 SPINDLE | | |
| 6135A | 8" | 2" thick polyester foam |
| STRAIGHT LINE SANDING PAD FOR MODEL 315 | | |
| 315-39 | N/A | Non-metallic material; fits similar brands of straight-line sanders |

The full range of Ingersoll Rand sanding, backing, and polishing pads will help you complete every sanding, polishing, and grinding job to your satisfaction.

315-39 Straight-line Sanding Pads

For use with model 315. Non-metallic material reduces side strap wear caused by metallic sanding pads. Fits other similar brands of straight-line sanders.



6135A Polishing Pads

Polishing pads have 8" diameter, 2" thick polyester foam. For use with models 314, 318, or any polisher with a 5/8"-11 spindle.

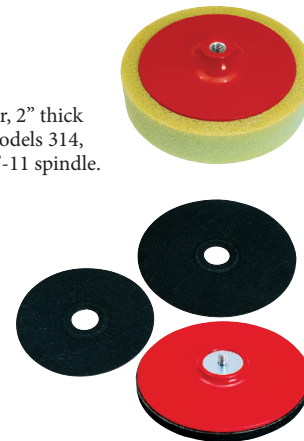

Air Drills and Screwdrivers



Ingersoll Rand air drills have industrial-grade chucks and keyless chuck versions that are extra-tough for drilling, sawing, valve guide reaming, cylinder honing, and wire brushing. They are powerful, efficient, and durable with smooth, quiet operation.



Air Drills and Screwdrivers

| Model | Chuck Size in (mm) | Free Speed rpm | Rated Power hp (kW) | Net Weight lb (kg) | Overall Length in (mm) | Average Air Consumption cfm (L/min) | Air Consumption @ Load cfm (L/min) | Sound Pressure / Power dBA | Air Inlet NPTF in | Min Hose Size in (mm) |
|-------------------------|--------------------|----------------|---------------------|--------------------|------------------------|-------------------------------------|------------------------------------|----------------------------|-------------------|-----------------------|
| 3/8" CHUCK DRILL | | | | | | | | | | |
| 7802A | 3/8" (10) | 2,000 | 0.5 (0.38) | 2.6 (1.1) | 7.8" (198) | 4 (113) | 26 (736) | 83 / 94 | 1/4" | 3/8" (10) |
| 7802RA | 3/8" (10) | 2,000 | 0.5 (0.38) | 2.9 (1.2) | 7.8" (198) | 4 (113) | 26 (736) | 82 / 93 | 1/4" | 3/8" (10) |
| 7802RAKC | 3/8" (10) | 2,000 | 0.5 (0.38) | 2.9 (1.2) | 7.4" (188) | 4 (113) | 26 (736) | 82 / 93 | 1/4" | 3/8" (10) |
| 1/2" CHUCK DRILL | | | | | | | | | | |
| 7803A | 1/2" (13) | 500 | 0.5 (0.38) | 3.2 (1.45) | 9" (229) | 4 (113) | 27 (765) | 83 / 94 | 1/4" | 3/8" (10) |
| 7803RA* | 1/2" (13) | 500 | 0.5 (0.38) | 3.3 (1.5) | 8.7" (221) | 4 (113) | 27 (765) | 83 / 94 | 1/4" | 3/8" (10) |
| 7803RAKC* | 1/2" (13) | 500 | 0.5 (0.38) | 3.3 (1.5) | 8.7" (221) | 4 (113) | 27 (765) | 83 / 94 | 1/4" | 3/8" (10) |

*Not pictured.

7802A

Air Drill

With its industrial-grade 3/8" chuck, this economical choice includes high-quality features for general drilling and hole-sawing jobs. The planetary gear reduction balances the load on bearings and gears for increased tool life.

- Variable speed throttle
- Lightweight, compact drill



7802RA

Reversible Air Drill

Use this economical, high-quality 3/8" drill for all your general purpose drilling, honing, reaming, and hole-sawing. With its reversible 0.5 hp motor, you can also drive and remove screws — including backing out tight screws without a struggle.

- Reversible motor with a quick reverse lever
- Variable speed throttle for starting holes easily
- Smooth, lightweight, compact drill



7802RAKC

Reversible Air Drill / Keyless Chuck

With its industrial-grade 3/8" chuck, this economical choice includes high-quality features for general drilling and hole-sawing jobs. The planetary gear reduction balances the load on bearings and gears for increased tool life.

- Variable speed throttle
- Lightweight, compact drill
- Keyless chuck



7803A

Air Drill

Here's the economical choice for power — a high-quality air drill designed for drilling, hole-sawing, cylinder honing, and any other job that calls for a 1/2" size. Its quality features for long life include the industrial-grade 1/2" chuck, ball and needle bearing construction, and double-reduction planetary gearing.

- No-load speed of 500 rpm
- Auxiliary side handle



Drill Bits

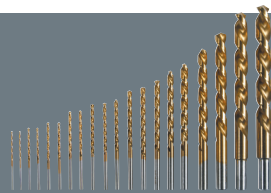

No matter what your drilling needs may be, count on Ingersoll Rand for the bits required to get the job done.

| Model | Free Speed rpm | Chuck Size in (mm) | Rated Power hp (kW) | Net Weight lb (kg) | Overall Length in (mm) | Average Air Consumption cfm (L/min) | Air Consumption @ Load cfm (L/min) | Sound Pressure / Power dBA | Air Inlet NPTF in | Min Hose Size in (mm) |
|--------------------------------|----------------|--------------------|---------------------|--------------------|------------------------|-------------------------------------|------------------------------------|----------------------------|-------------------|-----------------------|
| 1/4" MINI TOOL DRILL / DRIVER | | | | | | | | | | |
| 7804XP | 1,600 | 1/4" | N/A | 1.7 (0.78) | 7.3" (184) | 1.9 (54) | 17.5 (495) | 83.6 / 94.6 | 1/4" | 3/8" (10) |
| 3/8" CHUCK — RIGHT ANGLE DRILL | | | | | | | | | | |
| 7807R | 1,800 | 3/8" (10) | 0.33 (0.25) | 2.4 (1.13) | 8.1" (206) | 4 (113) | 17 (481) | 89 / 102 | 1/4" | 3/8" (10) |
| 1/4" CHUCK SCREWDRIVER | | | | | | | | | | |
| 371 | 1,800 | 1/4" hex | 0.44 (0.33) | 2.5 (1.15) | 7.4" (188) | 4 (113) | 29 (821) | 78 / 91 | 1/4" | 3/8" (10) |

7804XP

1/4" Mini Drill / Driver

- Double-sided, adjustable speed settings provide variability for a broader range of applications
- Double-bearing construction for longer life, impressive balance, and reduced vibration
- Reversible motor control

7804K

1/4" Mini Drill / Driver Kit

- Includes 22-piece drill bit and driver set



Hard-hitting 5-vane motor delivers smooth and robust performance

7807R

3/8" Angle Reversible Drill

The 7807R is an excellent choice for service work requiring a compact, low-profile angle head. It's a durable, reliable tool for drilling in all types of materials, including sheet metal, wood, and composites.

- Durable Jacobs multi-craft chuck
- Reversible, with convenient control
- Precision machine gearing ensures maximum power transfer and durability



371

Reversible Pistol-grip Screwdriver

The 371 is an excellent choice for soft-draw applications. This tool is well-suited for service work on HVAC systems, instrument panels, and trim components. It delivers reliable performance for driving sheet metal, self-tapping, and wood screws.

- Positive action clutch, for full torque throughout rundown
- Convenient one-handed operation, with reverse control at trigger
- Variable speed throttle for easy starts



Replacement Chucks and Chuck Keys

| Model | Capacity in (mm) | Thread in (mm) | Chuck Key Catalog Number | Tool Number |
|------------|------------------|-----------------------|--------------------------|--------------------------|
| 728-99-KC5 | 3/8" (10) | 3/8" x 24" (10 x 610) | Keyless | 7802, 7802R, 7811 |
| 728-99-KC8 | 1/2" (13) | 3/8" x 24" (10 x 610) | Keyless | 7806, 7803, 7803R, 7816R |
| 7803-99 | 1/2" (13) | 3/8" x 24" (10 x 610) | 7803-253 | 7803, 7803R, 7816R |



Drill Boots

| Part Number | Description | For Use With |
|-----------------------|---|-------------------------|
| PROTECTIVE TOOL BOOTS | | |
| 7802-BOOT | Air drill boot with Ingersoll Rand logo printed on red boot | 7802A, 7802RA, 7802RAKC |
| 7803-BOOT | Air drill boot with Ingersoll Rand logo printed on red boot | 7803A, 7803RA, 7803RAKC |

Air Hammers



Ingersoll Rand air hammers are designed so you can let the tool do the work, whether it's cutting, punching, chipping, or scraping. Each air hammer comes with a coil spring retainer for fast and easy chisel changes. You can also buy a five-piece chisel set, or get an Ingersoll Rand air hammer kit, which includes both the hammer and the chisel set.



Air Hammers

| Model | Shank Opening in (mm) | bpm @ 90 psi | Bore Diameter in (mm) | Stroke Length in (mm) | Weight lb (kg) | Length in (mm) | Average Air Consumption cfm (L/min) | Air Consumption @ Load cfm (L/min) | Sound Pressure / Power dBA | Air Inlet NPTF in | Min Hose Size in (mm) |
|--------|-----------------------|--------------|-----------------------|-----------------------|----------------|----------------|-------------------------------------|------------------------------------|----------------------------|-------------------|-----------------------|
| 115 | 0.401" (10.1) | 5,000 | 0.75" (19) | 1.63" (41) | 2.6 (1.18) | 6.1" (155) | 2 (57) | 14 (396) | 101.3 / 114.3 | 1/4" | 3/8" (10) |
| 115K* | 0.401" (10.1) | 5,000 | 0.75" (19) | 1.63" (41) | 2.6 (1.18) | 6.1" (155) | 2 (57) | 14 (396) | 101.3 / 114.3 | 1/4" | 3/8" (10) |
| 116 | 0.401" (10.1) | 3,500 | 0.69" (17.5) | 2.63" (67) | 3.4 (1.54) | 7.8" (198) | 3 (85) | 15 (425) | 104.4 / 117.4 | 1/4" | 3/8" (10) |
| 116K* | 0.401" (10.1) | 3,500 | 0.69" (17.5) | 2.63" (67) | 3.4 (1.54) | 7.8" (198) | 3 (85) | 15 (425) | 104.4 / 117.4 | 1/4" | 3/8" (10) |
| 117 | 0.401" (10.1) | 2,000 | 0.69" (17.5) | 3.5" (89) | 4.1 (1.86) | 9.9" (251) | 3 (85) | 14 (396) | 103.5 / 116.5 | 1/4" | 3/8" (10) |
| 117K* | 0.401" (10.1) | 2,000 | 0.69" (17.5) | 3.5" (89) | 4.1 (1.86) | 9.9" (251) | 3 (85) | 14 (396) | 103.5 / 116.5 | 1/4" | 3/8" (10) |
| 121-K6 | 0.401" (10.1) | 3,000 | 0.75" (19) | 2.28" (58) | 3.5 (1.59) | 7.6" (194) | 3 (85) | 15 (425) | 98.3 / 111.3 | 1/4" | 3/8" (10) |
| 121/Q* | 0.401" (10.1) | 3,000 | 0.75" (19) | 2.28" (58) | 3.5 (1.59) | 7.6" (194) | 3 (85) | 15 (425) | 98.3 / 111.3 | 1/4" | 3/8" (10) |
| 132* | 0.401" (10.1) | 1,725 | 0.56" (14) | 4.00" (102) | 3.4 (1.54) | 8.5" (216) | 3 (85) | 11 (311) | N/A | 1/4" | 5/16" (8) |

*Not pictured.

115

Air Hammer

This powerful yet economical high-speed air hammer is designed for light exhaust system work and general cutting, chipping, and scraping.

- Up to 5,000 blows per minute
- Alloyed steel barrel and heat-treated piston for longer life
- Built-in power regulator and trigger control

Also available: 115K includes 5-piece chisel kit.



116

Air Hammer

The economical air hammer for fast cutting action, especially for medium exhaust system, panel cutting, and general repair work.

- Up to 3,500 blows per minute
- Handles a range of cutting applications
- Longer-life alloyed steel barrel and heat-treated piston

Also available: 116K includes 5-piece chisel kit.



117

Air Hammer

An economical air hammer with a longer piston stroke, this tool is designed for exhaust work, bolt cutting, and front-end work. The trigger control and a built-in power regulator give you full control of the speed and power.

- Longer-stroke piston
- Alloyed steel barrel and heat-treated piston for longer life
- Up to 2,000 blows per minute

Also available: 117K includes 5-piece chisel kit.



121-K6

Air Hammer Kit

Make fast work of body panel crimping and cutting, bushing, driving, shearing, and general front-end work with this air hammer.

- 3,000 blows per minute
- Tough 1-piece alloy barrel
- Kit includes blow-molded case and 6-piece chisel set

Also available: 121/Q tool only.



9500 Chisel Set

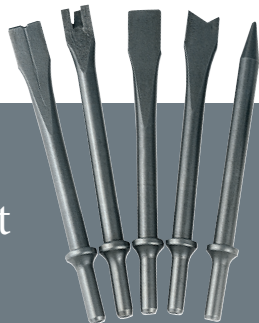

A five-piece chisel set in a plastic pouch with 0.401" shank diameters to match your Ingersoll Rand air hammer.

Needle and Chisel Scaler

| Model | Needle Quantity | Needle Size in (mm) | bpm @ Free Speed rpm | Bore Diameter in (mm) | Stroke Length in (mm) | Weight lb (kg) | Length in (mm) | Average Air Consumption cfm (L/min) | Air Consumption @ Load cfm (L/min) | Sound Pressure / Power dBA | Air Inlet NPTF in | Min Hose Size in (mm) |
|--------|-----------------|---------------------|----------------------|-----------------------|-----------------------|----------------|----------------|-------------------------------------|------------------------------------|----------------------------|-------------------|-----------------------|
| 125 | 19 | 1/8" (3.2) | 4,600 | 1" (25) | 1.1" (28.6) | 6.2 (2.8) | 18.3" (465) | 8 (226) | 15 (425) | 99.6 / 112.6 | 1/4" | 5/16" (8) |
| 125CI* | N/A | N/A | 4,600 | 1" (25) | 1.1" (28.6) | 4.1 (1.9) | 11.4" (289) | 8 (226) | 15 (425) | 99.6 / 112.6 | 1/4" | 5/16" (8) |

*Not pictured.

125

Needle Scaler

For surface preparation work involving the cleaning or removal of paint, rust, dirt, or weld slag, the 125 is a durable, dependable, and economical solution.

- 19 needles
- Each needle diameter measures 1/8"
- 4,600 blows per minute at free speed



125 Chisels

| Model | Type | Width* in (mm) |
|-------------|--------------|----------------|
| WF-14B-007 | Wide Chisel | 1-3/8" (35) |
| WF-14A-007 | Spoon Chisel | 1-3/8" (35) |
| WF-14C-008 | Wide Chisel | 2" (50) |
| WF-14D-008 | Wide Chisel | 3" (75) |
| PF2200-3231 | Round nose | 1/4" (6) |
| PF2200-3232 | Cape chisel | 1/4" (6) |

*All chisels are 7" in length.

125CI

Chisel Scaler

Same great features as the 125 only instead of needles, tool uses a chisel.



Replacement Needle Set

| Part Number | Description | Width* in (mm) |
|--------------|-------------|----------------|
| PF2219-22-19 | Needle set | 1/8" (3) |

*All chisels are 7" in length.

Spring Retainers

| Model | Description | For Use With |
|------------|------------------|---------------|
| 115-183 | Spring retainer | 115, 116, 117 |
| AVC10-183A | Spring retainer | 121, 132 |
| AVC1-83 | Beehive retainer | 121, 132 |

Replacement Chisels

| Model | Description |
|--------|--|
| 9500 | 5-piece hammer chisel set |
| 9505 | Hammer spring retainer, 2 pack |
| 9512 | Quick change hammer retainer for 121, 132, 115, 116, 117 |
| 950011 | Tailpipe cut-off tool |
| 950012 | Slotted panel cutter |
| 950013 | Rivet and bolt cutter |
| 950014 | Pneumatic scraper |
| 950015 | Pneumatic hammer chisel |
| 950016 | Pneumatic cold chisel, 8" |
| 950017 | Pneumatic cold chisel |
| 950018 | Muffler and tailpipe remover |
| 950019 | Pneumatic ball joint separator |

Mini Air Tools



Our mini tools range in size between 5" and 7-1/4" in length, making them small enough to easily fit in the palm of almost anyone's hand, and ideal for tight spaces and fine detail finish work. They perfectly complement our existing lineup of full-size automotive maintenance and repair tools — delivering the power, versatility, and durability that you have come to expect from Ingersoll Rand.

The mini tools feature composite housings with ergonomic textured grips to provide comfort and exceptional resistance to grease, chemicals, and extreme temperatures. They also feature lightweight, pistol-grip designs with thumb-actuated switches engineered for balance and one-handed operation, variable-speed triggers, and a complete accessory package.

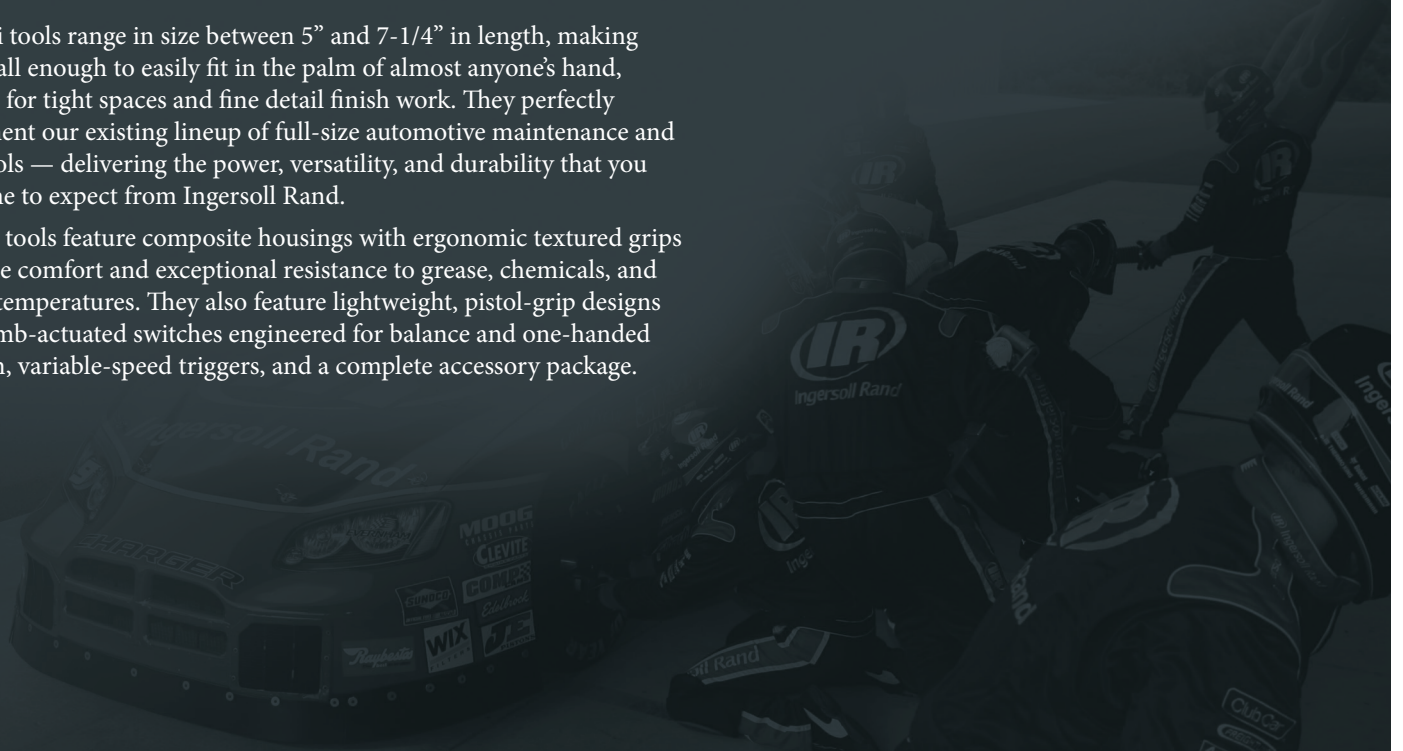

Mini Tools

2101XP Specifications

| | |
|-------------------------------------|-------------------|
| Drive - in | 1/4" |
| Torque Range (forward) - ft-lb (Nm) | 25 - 40 (34 - 54) |
| Max Torque (reverse) - ft-lb (Nm) | 50 (68) |
| Free Speed - rpm | 11,000 |
| Blows Per Minute - bpm | 1,250 |
| Standard Bolt Capacity - in | 5/16" |
| Net Weight - lb (kg) | 1.4 (0.6) |
| Kit Weight - lb (kg) | 3 (1.4) |
| Overall Length - in (mm) | 6.3 (160) |
| Average Air Consumption - cfm | 1.8 |
| @ Load - cfm | 18.2 |
| Sound (pressure / power) - dBA | 81.8/92.8 |
| Air Inlet - in | 1/4" |
| Min Hose Size - in | 3/8" |

2101XP-QC Specifications

| | |
|-------------------------------------|-------------------|
| Drive - in | 1/4" |
| Torque Range (forward) - ft-lb (Nm) | 25 - 40 (34 - 54) |
| Max Torque (reverse) - ft-lb (Nm) | 50 (68) |
| Free Speed - rpm | 11,000 |
| Blows Per Minute - bpm | 1,250 |
| Standard Bolt Capacity - in | 5/16" |
| Net Weight - lb (kg) | 1.4 (0.7) |
| Kit Weight - lb (kg) | 3 (1.4) |
| Overall Length - in (mm) | 6.8 (173) |
| Average Air Consumption - cfm | 1.8 |
| @ Load - cfm | 18.2 |
| Sound (pressure / power) - dBA | 81.8/92.8 |
| Air Inlet - in | 1/4" |
| Min Hose Size - in | 3/8" |

2102XP Specifications

| | |
|-------------------------------------|-------------------|
| Drive - in | 3/8" |
| Torque Range (forward) - ft-lb (Nm) | 25 - 40 (34 - 54) |
| Max Torque (reverse) - ft-lb (Nm) | 50 (68) |
| Free Speed - rpm | 11,000 |
| Blows Per Minute - bpm | 1,250 |
| Standard Bolt Capacity - in | 5/16" |
| Net Weight - lb (kg) | 1.4 (0.6) |
| Kit Weight - lb (kg) | 3 (1.4) |
| Overall Length - in (mm) | 6.3 (160) |
| Average Air Consumption - cfm | 1.8 |
| @ Load - cfm | 18.2 |
| Sound (pressure / power) - dBA | 81.8/92.8 |
| Air Inlet - in | 1/4" |
| Min Hose Size - in | 3/8" |



2101XP

1/4" Mini Impactool

- Powerful impact mechanism is engineered to deliver 45 ft.-lb. (61 Nm) of torque (forward) where you need it most
- Hard-hitting five-vane motor delivers smooth and robust performance
- Easily accessible forward / reverse switch for one-handed operation



2101XP-QC

1/4" Quick Change Mini Impactool

- Powerful impact mechanism is engineered to deliver 45 ft.-lbs. (61 Nm) of torque (forward) where you need it most
- Hard-hitting 5-vane motor delivers smooth and robust performance
- Easily accessible forward/reverse switch for one-handed operation
- Quick change feature allows for simple and convenient attachment exchange



2102XP

3/8" Mini Impactool

- Powerful impact mechanism is engineered to deliver 45 ft.-lbs. (61 Nm) of torque (forward) where you need it most
- Hard-hitting 5-vane motor delivers smooth and robust performance
- Easily accessible forward/reverse switch for one-handed operation
- Ideal for those hard-to-reach places where conventional tools cant go

Mini Tools

7804XP Specifications

| | |
|--------------------------------|-----------|
| Drive - in | 1/4" |
| Torque - ft-lbs (Nm) | 1.1 (1.5) |
| Free Speed - rpm | 1,600 |
| Net Weight - lb (kg) | 1.7 (0.8) |
| Kit Weight - lb (kg) | 2.7 (1.2) |
| Overall Length - in (mm) | 7.3 (185) |
| Average Air Consumption - cfm | 1.9 |
| @ Load - cfm | 17.5 |
| Sound (pressure / power) - dBA | 83.6/94.6 |
| Air Inlet - in | 1/4" |
| Min Hose Size - in | 3/8" |



7804XP

1/4" Mini Drill/Driver

- Hard-hitting five-vane motor delivers smooth and robust performance
- Double-sided, adjustable speed settings provide variability for a broader range of applications
- Double-bearing construction for longer life, impressive balance, and reduced vibration
- Reversible motor control

3103XP Specifications

| | |
|--------------------------------|-----------|
| Drive - in | 1/4" |
| Free Speed - rpm | 15,000 |
| Rated Power - hp | 0.2 |
| Net Weight - lb (kg) | 1.0 (0.5) |
| Kit Weight - lb (kg) | 2.7 (1.2) |
| Overall Length - in (mm) | 5 (127) |
| Average Air Consumption - cfm | 2.1 |
| @ Load - cfm | 19.4 |
| Sound (pressure / power) - dBA | 84.9/95.9 |
| Air Inlet - in | 1/4" |
| Min Hose Size - in | 3/8" |



3103XP

Mini Surface Prep Sander

- Ideal for the removal of rust, surface deposits, and welds in hard-to-reach areas
- Ball-bearing construction enhances durability and smooth power delivery
- Includes 2" and 3" medium backing pads

3128XP Specifications

| | |
|--------------------------------|-----------|
| Pad Size - in (mm) | 3" (75) |
| Free Speed - rpm | 15,000 |
| Rated Power - hp | 0.2 |
| Net Weight - lb (kg) | 1.1 (0.5) |
| Kit Weight - lb (kg) | 2.8 (1.3) |
| Overall Length - in (mm) | 5.5 (140) |
| Average Air Consumption - cfm | 2.1 |
| @ Load - cfm | 14.7 |
| Sound (pressure / power) - dBA | 84.2/96.9 |
| Air Inlet - in | 1/4" |
| Min Hose Size - in | 3/8" |



3128XP

Mini Random Orbital Sander

- Engineered for the most aggressive sanding applications
- Delivers swirl-free finishes when feather edging, removing rust, preparing metal surfaces, or smoothing welds
- Durable ball-bearing construction ensures smooth power delivery
- Includes 3" hook & loop style backing pad

3129K Specifications

| | |
|--------------------------------|------------|
| Pad Size - in (mm) | 3" (75) |
| Free Speed - rpm | 6,000 |
| Rated Power - hp | 0.3 |
| Net Weight - lb (kg) | 1.3 (0.6) |
| Kit Weight - lb (kg) | 2.9 (1.3) |
| Overall Length - in (mm) | 6" (152) |
| Average Air Consumption - cfm | 2.2 |
| @ Load - cfm | 19.9 |
| Sound (pressure / power) - dBA | 83.5/94.85 |
| Air Inlet - in | 1/4" |
| Min Hose Size - in | 3/8" |



3129XP

Mini Polisher

- Ideal for buffing and polishing paint, metal, and plastic surfaces to a highgloss finish
- Free speed of 6,000 rpm delivers the same performance of polishers twice the size
- Double-sided, adjustable speed settings provide variability for a broader range of applications
- Includes 3" hook & loop style backing pad

Mini Tool Kits

2101K

Mini 1/4" Impactool Kit



Kit Includes 2101XP and 10-piece 1/4" socket set

7804K

Mini 1/4" Drill/Driver Kit



Kit Includes 7804XP and 22-piece drill bit and driver set

3103K

Mini Surface Prep Sander Kit



Kit Includes 3103XP and 14-piece 2" and 3" sanding discs

3128K

Mini Random Orbital Sander Kit



Kit Includes 3128XP and 71-piece hook & loop discs

3129K

Mini Polisher Kit



Kit Includes 3129XP and 4-piece hook & loop pads

Mini Tool Accessories

| Part Number | Description |
|---------------------------|---|
| MINI POLISHER ACCESSORIES | |
| 03H-PAD-HL | 3" hook-and-loop backer pad (fits polisher and RO sander) |
| 03F-SFTWL-6 | 3" hook-and-loop wool pad (for compounding) |
| 03F-MEDFM-6 | 3" hook-and-loop waffle pad white (for compounding) |
| 03F-SFTFM-6 | 3" hook-and-loop waffle pad yellow (for polishing) |



3" hook-and-loop backer pad



3" hook-and-loop wool pad

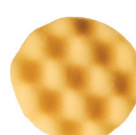

3" hook-and-loop waffle pad, white



3" hook-and-loop waffle pad, yellow



6-piece box as shown

| Part Number | Description | Grit |
|---------------------------|--------------------------------------|------|
| 3" HOOK AND LOOP AO PAPER | | |
| 03H-040AO-50 | 3" hook-and-loop aluminum oxide disc | 40 |
| 03H-080AO-50 | 3" hook-and-loop aluminum oxide disc | 80 |
| 03H-100AO-50 | 3" hook-and-loop aluminum oxide disc | 100 |
| 03H-120AO-50 | 3" hook-and-loop aluminum oxide disc | 120 |
| 03H-180AO-50 | 3" hook-and-loop aluminum oxide disc | 180 |
| 03H-220AO-50 | 3" hook-and-loop aluminum oxide disc | 220 |
| 03H-240AO-50 | 3" hook-and-loop aluminum oxide disc | 240 |
| 03H-320AO-50 | 3" hook-and-loop aluminum oxide disc | 320 |
| 03H-360AO-50 | 3" hook-and-loop aluminum oxide disc | 360 |
| 03H-400AO-50 | 3" hook-and-loop aluminum oxide disc | 400 |
| 03H-500AO-50 | 3" hook-and-loop aluminum oxide disc | 500 |
| 03H-800AO-50 | 3" hook-and-loop aluminum oxide disc | 800 |



50-piece box as shown

Air Compressors and System Components



For more than 75 years, Ingersoll Rand has been the world leader in air compressors and air system accessories. We understand the needs and requirements for air systems and the business demands that you face every day. Rising energy costs and reduced margins require increased reliability and efficiency from not only your air compressor, but your entire air system. Simply stated, your air system is much more than an air compressor. It's the complete system — the piping, filters, dryers, drains, hoses, valves, and point-of-use tools.



Selecting an Air Compressor — FAQs

How will compressed air be used?

The type of work being performed is probably the most important factor in selecting a compressor.

Where will the compressor be located?

Indoors: heated environment to prevent air lines from freezing while providing sufficient ventilation to cool compressor where elevated temperatures may exist. Outdoors: protection against ambient environment and provisions for cold-weather starting.

How much pressure (psi) is needed?

Compressor discharge pressure must exceed the psi requirement of all pneumatic tools or equipment being operated.

How much airflow (cfm) is needed?

Cubic feet per minute (cfm) is the measure of airflow the compressor can create. The measurement cfm is stated in two different forms: piston displacement (pd) or actual cubic feet per minute (acfm). Always consider acfm, as it reflects the amount of useable compressed air.

What horsepower is required?

Horsepower is directly proportional to the cfm rating of the compressor. The higher the horsepower, the more air (cfm) the compressor can deliver. Do not rely solely on horsepower when specifying or selecting an air compressor.

What type and size of tank is needed?

The tank provides a reserve of air to meet peak flow and pressure demands. The larger the receiver, the more reserve available. Tanks are available in vertical and horizontal designs; configuration is dependent upon available floor space.

What are the electrical requirements?

Identify available incoming electrical service before specifying an air compressor. Always have a qualified electrician review electrical requirements.

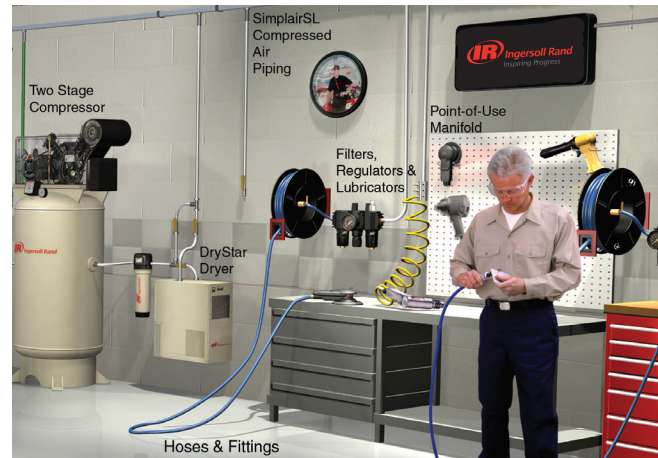

Know Your Power Source

All residential and commercial buildings have 115 V / 60 Hz power. Many residential, commercial, and industrial buildings have 230 V / single-phase / 60 Hz power, but this should be confirmed. When electric power is not available, select a gas engine-driven compressor. Do not use a gas engine compressor indoors.

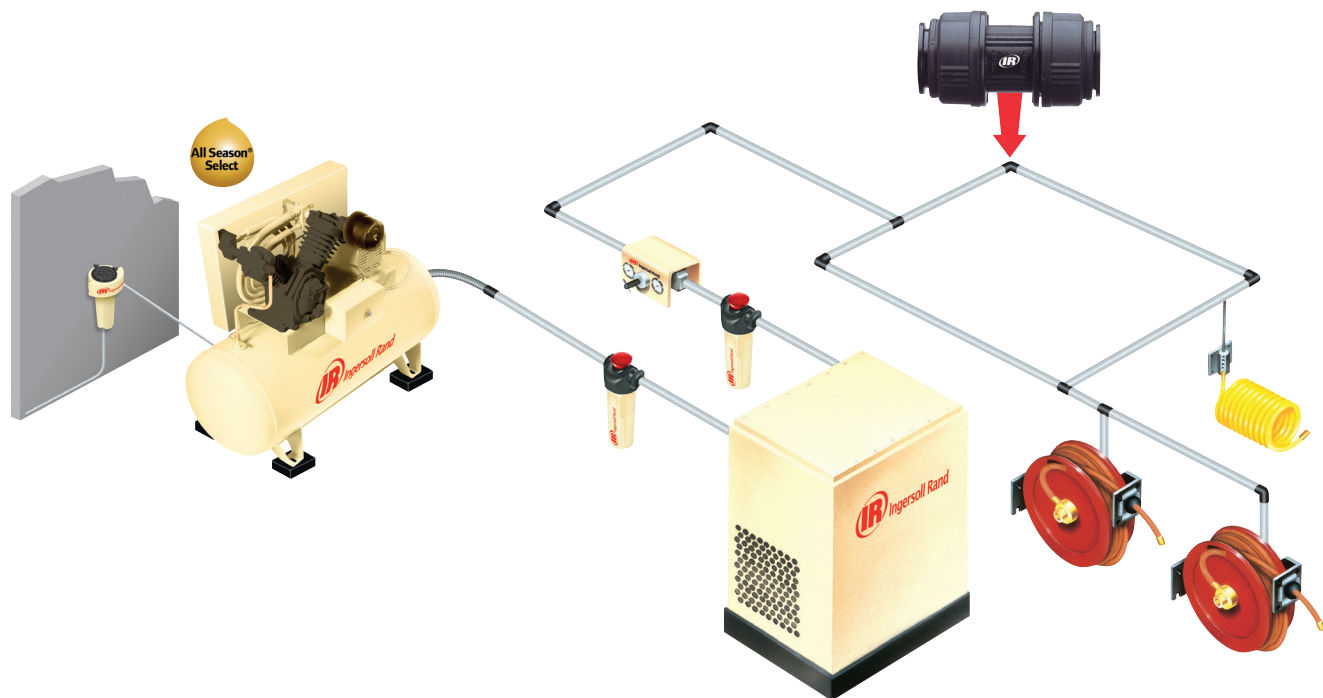

Single and Two-stage Air Compressors

Single-stage

Single-stage models compress air to a final pressure in one stroke. They generally are used for pressures between 70 and 90 psi (maximum pressure to 135 psi).

- Oversized belt wheel provides reliable design and cooler operation
- Durable cast-iron cylinders, heads, and frame are designed for continuous operation and extended pump life
- Extended service intervals — Ingersoll Rand synthetic lubricant provides 2,000-hour oil change intervals (four times longer than mineral-based lubricants)
- High-efficiency stainless steel finger valves are simple, efficient, and easy to maintain
- Manual thermal overload protection of the motor — no starter required
- Sight glass makes it easy to check oil level



Two-stage

A two-stage model compresses air to an intermediate pressure in the first stage, removes heat compression through an intercooler, and compresses air to a final pressure in a second compression stage. Two-stage compressors are more efficient and are generally used for pressures above 100 psi (maximum pressure to 175 psi).

- Two-stage design provides 175 psi operation
- Removable cylinders are easy to repair and provide even 360° cooling, which helps eliminate hot spots
- One-piece connecting rod for fewer wear parts
- Low oil level switch provides constant protection
- Centrifugal unloader ensures loadless starts, providing maximum starter protection
- Finned copper intercooler runs cooler in even the most demanding conditions
- Overhung crankshaft is precision-balanced to run smoothly and quietly
- Splash lubrication is simple and reliable



Single-stage Air Compressors

| Model | Running Power hp | Voltage DC volts | Tank Capacity gal | Airflow @ 90 psi acfm | Max psi | Air NPT Outlet in | Package Dimensions L x W x H in | Net Weight lb |
|----------------------------------|------------------|------------------|-------------------|-----------------------|---------|-------------------|---------------------------------|---------------|
| SINGLE-STAGE UNIT — TWIN STACK | | | | | | | | |
| P1IU-A9 | 2 | 115-1-60 | 4.5 twin | 4.4 | 125 | 3/8" | 21" x 15" x 17" | 58 |
| SINGLE-STAGE UNITS — GARAGE MATE | | | | | | | | |
| P1.5IU-A9 | 2 | 115-1-60 | 20 vert | 5.2 | 135 | 3/8" | 22" x 23" x 43" | 200 |
| SS3F2-GM | 2 | 115-1-60 | 30 horiz | 5.7 | 135 | 3/8" | 46" x 25" x 35" | 185 |

Twin-stack

Single-stage — Portable

The Ingersoll Rand twin-stack air compressor is designed to provide power, durability, and portability on the jobsite. Built to last, this oil-lube compressor with durable cast-iron cylinders is designed for 100% continuous-duty applications. The twin-stack includes a 1/4" universal coupler, conveniently mounted regulator and pressure gauge, 4.5-gallon twin tanks, All-Season Select® lubricant, and a power cord.

- Lightweight and compact
- Durable cast-iron construction
- Extended pump life — double the life of similar oil-free products



P1IU-A9

Garage Mate

Single-stage — Portable

Designed for professionals and serious do-it-yourselfers, the Garage Mate compact compressor delivers maximum air for impact guns, ratchets, grinders, drills, nail guns, paint sprayers, sanders, and more. This portable single-stage compressor provides the power you need to get the job done faster.

- 100% cast-iron cylinders and frame
- Manual thermal overload motor protection
- Belt-driven for quiet operation — 80 dBa



P1.5IU-A9

Single-stage Air Compressors

| Model | Running Power hp | Voltage DC volts | Engine | Tank Capacity gal | Airflow @ 90 psi acfm | Max psi | Air NPT Outlet in | Package Dimensions L x W x H in | Net Weight lb |
|--|------------------|------------------|--------|-------------------|-----------------------|---------|-------------------|---------------------------------|---------------|
| WHEELBARROW SINGLE-STAGE — ELECTRIC-DRIVEN | | | | | | | | | |
| SS3J2-WB | 2 | 115 / 230-1-60 | N/A | 8 twin | 5.7 | 135 | 3/8" | 43" x 18" x 25" | 175 |
| SS3J3-WB | 3 | 230-1-60 | N/A | 8 twin | 11.3 | 135 | 3/8" | 43" x 18" x 25" | 175 |
| WHEELBARROW SINGLE-STAGE — GASOLINE-DRIVEN | | | | | | | | | |
| SS3J5.5GH-WB | 5.5 | N/A | Honda | 8 twin | 11.8 | 135 | 3/8" | 43" x 18" x 25" | 175 |

Wheelbarrow

Single-stage — Portable

Ingersoll Rand electric and gas engine-driven wheelbarrow air compressors are lightweight with a low-profile design to provide maximum maneuverability. Built to last, these cast-iron, oil-lube compressors are designed for 100% continuous-duty applications. Includes pressure switch, regulator, and gauge; two quick disconnects to power multiple tools; and twin 8-gallon capacity tanks. Electric model features a belt drive to provide quiet operation (76 dBA), a 6' power cord, and dual voltage (2-hp model only). Where electric power is not readily available, the gas-driven model is powered by either a 5.5-hp Honda or Briggs & Stratton high-performance engine.

- Designed for maximum maneuverability on the jobsite
- Durable cast iron construction
- 100% continuous-duty for tough applications
- Includes two quick disconnects to power multiple tools



SS3J5.5GH-WB

Installation Kits

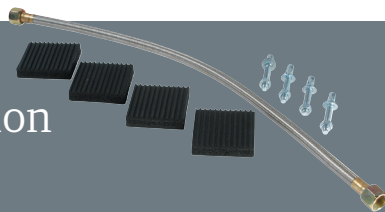

The complete line of Ingersoll Rand Installation Kits can be found on page 66. The complete line of Ingersoll Rand air compressor accessories can be found on pages 63-66.

Single-stage Air Compressors

| Model | Running Power hp | Voltage DC volts | Tank Capacity gal | Airflow @ 90 psi acfm | Max psi | Air NPT Outlet in | Package Dimensions L x W x H in | Net Weight lb |
|--------------------------------|------------------|------------------|-------------------|-----------------------|---------|-------------------|---------------------------------|---------------|
| SINGLE-STAGE — ELECTRIC-DRIVEN | | | | | | | | |
| SS3L3 | 3 | 230-1-60 | 60 vert | 11.3 | 135 | 3/8" | 20" x 23" x 66" | 300 |
| SS5L5 | 5 | 230-1-60 | 60 vert | 18.1 | 135 | 1/2" | 20" x 30" x 71" | 310 |

Single-stage

Electric-driven

Our single-stage electric air compressors are ideal for almost anyone — from the do-it-yourselfer to the professional air compressor user. Each compressor features durable cast iron construction, 100 percent continuous-duty cycle for the toughest applications, and extended pump life for years of trouble-free service.

- Industrial-quality design
- Durable cast-iron construction
- 135 psi maximum operating pressure



Two-stage Air Compressors

| Model | Running Power hp | Engine | Tank Capacity gal | Airflow @ 175 psi acfm | Max psi | Air NPT Outlet in | Package Dimensions L x W x H in | Net Weight lb |
|--------------------------------|------------------|---------|-------------------|------------------------|---------|-------------------|---------------------------------|---------------|
| TWO-STAGE TYPE 30 — GAS-DRIVEN | | | | | | | | |
| 2475F14G | 14 | Kohler* | 30 horiz | 25 | 175 | 1/2" | 44" x 22" x 46" | 424 |
| 2475F13GH | 13 | Honda* | 30 horiz | 25 | 175 | 1/2" | 44" x 22" x 41" | 430 |

*Includes alternator.

Type 30 Series

Gas-driven

Ingersoll Rand Type 30 two-stage compressors meet the needs of fleet or field service applications. Featuring truck-bed mounting, Type 30 units include electronic ignition, idle engine control, a 30-gallon ASME receiver, an OSHA-approved, fully enclosed belt guard, a weather-resistant powdercoat paint finish, and an extended pump life.

- Durable cast-iron construction
- 175 psi maximum operating pressure
- Easy installation
- 100% duty cycle
- Two-year pump warranty with purchase of start-up kit



Two-stage Air Compressors

| Model | Running Power hp | Tank Capacity gal | Airflow @ 175 psi acfm | Max psi | Air NPT Outlet in | Package Dimensions L x W x H in | Net Weight lb | Start-up Kit Part Number |
|--------------------------|------------------|-------------------|------------------------|---------|-------------------|---------------------------------|---------------|--------------------------|
| TYPE 30 STANDARD PACKAGE | | | | | | | | |
| 2340L5-V | 5 | 60 vert | 14.7 | 175 | 1/2" | 20" x 33" x 69" | 400 | 32305880 |
| 2340N5-V | 5 | 80 vert | 14.7 | 175 | 1/2" | 24" x 33" x 67" | 475 | 32305880 |
| 2475N5-V | 5 | 80 vert | 16.8 | 175 | 1/2" | 26" x 38" x 70" | 500 | 32305880 |
| 2475N7.5-V | 7.5 | 80 vert | 24 | 175 | 3/4" | 26" x 38" x 70" | 500 | 32305880 |
| 2545E10-V | 10 | 120 horiz | 35 | 175 | 3/4" | 73" x 28" x 51" | 835 | 32305898 |
| 2545EK10-V | 10 | 120 vert | 35 | 175 | 3/4" | 44" x 32" x 82" | 985 | 32305898 |
| 7100E15-V | 15 | 120 horiz | 50 | 175 | 3/4" | 72" x 29" x 57" | 1,035 | 32305898 |

*Available voltages: 230/1/60 (5 – 7.5 hp only), 200/1/60 (2475, 5 hp), 200/3/60, 230/3/60, 460/3/60. Please specify voltage required when placing your order.

Type 30 Value Package

5 to 15 Horsepower

Ingersoll Rand, the world leader in air power, brings industrial-class, two-stage compressors to automotive applications. Featuring a cast-iron pump with splash lubrication for efficient operation and easy serviceability, this new range delivers non-stop performance and reliability for commercial or automotive service applications. Type 30 compressors have been designed to generate maximum air output at 175 psi, with more than 10,000 hours of durability.

- 100% cast iron cylinder head with deep-groove directional cooling fins
- High-efficiency stainless steel valves
- Oversized industrial-grade bearings for extended pump life
- High-efficiency intercooler
- 100% cast iron pump
- High-efficiency inlet air filter with sound attenuation baffles
- Balanced pistons for maximized efficiency and minimized vibration
- Oversized cast-iron balanced belt wheel to allow continuous-duty operation
- Two-year pump warranty with purchase of start-up kit



Purchase an Ingersoll Rand start-up kit and increase the warranty on your pump from one year to two years!



Air Compressors

Electric Drain Valves



Ingersoll Rand electric drain valves (EDV) are full-feature automatic electronic drain valves that deliver drier air by removing condensate from compressors, receivers, dryers, aftercoolers, filters, and drip legs. Ingersoll Rand air compressor accessories can be found on pages 63-66.

Two-stage Air Compressors

| Model | Running Power hp | Tank Capacity gal. | Airflow @175 psi acfm | Max psi | Air NPT Outlet in | Package Dimensions L x W x H in | Net Weight lb |
|------------|------------------|--------------------|-----------------------|---------|-------------------|---------------------------------|---------------|
| 2545E10-VP | 10 | 120 horiz | 35 | 175 | 3/4" | 72" x 30" x 56" | 835 |
| 2545K10-VP | 10 | 120 vert | 35 | 175 | 3/4" | 44" x 32" x 82" | 830 |

Type 30 Value Plus Packages

For applications that demand a heavier-duty cycle. Step up to this enhanced version of our base package. It is ideal for light industry applications. The Value Plus Package comes factory-fitted with options for unmatched reliability in most diversified applications

- 100% Cast-Iron Pump for durability
- 100% Continuous Duty Rating
- Designed to run 24 hours a day
- Two-year pump warranty with purchase of IR start-up kit
- 175 Maximum PSI for greater storage capabilities
- Magnetic starter
- ASME rated Storage Tank
- Auto Start & Stop Control
- Electronic Drain Valve
- Air-cooled After-cooler
- Nation-wide Service Coverage



Two-stage Air Compressors

| Model | Running Power hp | Tank Capacity gal | Airflow @ 175 psi acfm | Max psi | Air NPT Outlet in | Package Dimensions L x W x H in | Net Weight lb | Start-up Kit Part Number |
|-------------------------|------------------|-------------------|------------------------|---------|-------------------|---------------------------------|---------------|--------------------------|
| TYPE 30 PREMIUM PACKAGE | | | | | | | | |
| 2475N5-P | 5 | 80 vert | 16.8 | 175 | 3/4" | 30" x 37" x 73" | 500 | 32305880 |
| 2475N7.5-P | 7.5 | 80 vert | 24 | 175 | 3/4" | 26" x 38" x 70" | 500 | 32305880 |
| 2545E10-P | 10 | 120 horiz | 35 | 175 | 3/4" | 72" x 30" x 56" | 835 | 32305898 |
| 2545K10-P | 10 | 120 vert | 35 | 175 | 3/4" | 44" x 32" x 82" | 850 | 32305898 |
| 7100E15-P | 15 | 120 horiz | 50 | 175 | 1" | 72" x 30" x 56" | 1,035 | 32305898 |

*Available voltages: 230/1/60 (5 – 7.5 hp only), 200/3/60, 230/3/60, 460/3/60.
Please specify voltage required when placing your order.

Type 30 Premium Packages

In addition to the features on our Value Packages, the Premium Package models include:

- Air-cooled aftercooler to help remove additional moisture
- Low oil protection switch to prevent the pump from running dry
- Electronic drain valve that automatically drains water from compressor tank
- Two-year pump warranty with purchase of start-up kit
- Magnetic motor starter



Purchase an Ingersoll Rand start-up kit and increase the warranty on your pump from one year to two years!

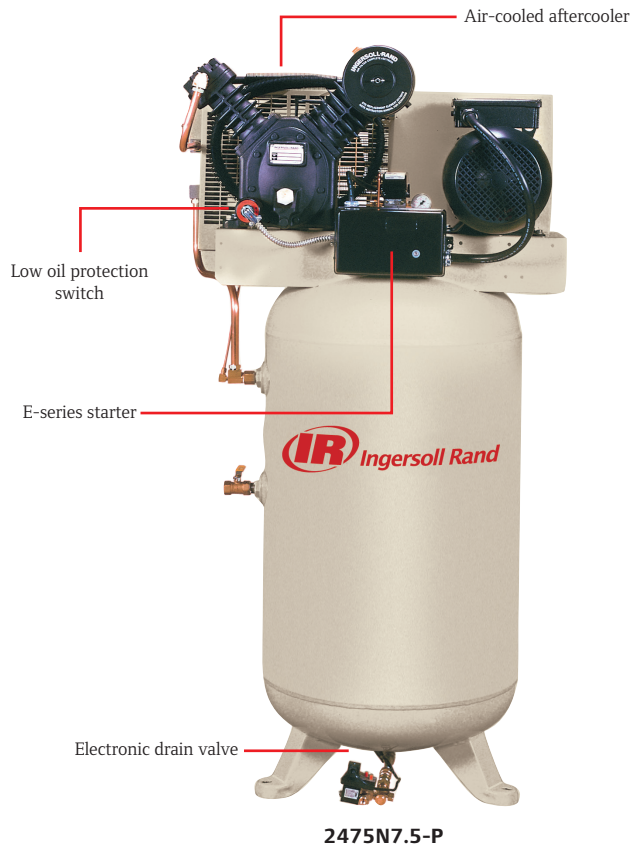

Lubricants



All-Season Select lubricant is a synthetic, all-temperature blend designed to increase efficiency, reduce wear, and prevent carbon build-up. Use of All-Season Select lubricant extends pump warranty to two years. Ingersoll Rand air compressor accessories can be found on pages 63-66.

Rotary Screw Air Compressors

Rotary screw models compress air through two oil-flooded, intermeshed helical screws. This form of compression offers maximum efficiency at much higher air quality levels than reciprocating models with constant pressure capabilities. Rotary screw air compressors can operate 24/7, continuous-duty at extremely quiet noise levels compared to reciprocating compressors, and have up to five times the operating life.

- Low sound — operates at low sound levels of 64 to 69 dBA
- Closely maintained pressure delivers pulse-free air
- 9,000-hour / 2-year coolant — Ultra-Plus coolant offers superior separation for lower coolant make-up, and will not varnish or sludge; improved cooling characteristics reduce operating temperatures, improving the life of the airend



High-efficiency
Integrated Compression
Module



Rotary Screw
Airends

UP Series 5-15 HP

| Model | Running Power hp | Tank Capacity gal | Airflow acfm | Discharge Pressure psi | Air NPT Outlet in | Package Dimensions in | Net Weight lb |
|-------------|---------------------|----------------------|-----------------|---------------------------|----------------------|--------------------------|------------------|
| UP6-5-125 | 5 | 80 | 18.5 @ 125 psi | 125 | 3/4" | 53.6" x 28.9" x 60.7" | 925 |
| UP6-5-150 | 5 | 80 | 16 @ 150 psi | 150 | 3/4" | 53.6" x 28.9" x 60.7" | 925 |
| UP6-7.5-125 | 7.5 | 80 | 28 @ 125 psi | 125 | 3/4" | 53.6" x 28.9" x 60.7" | 925 |
| UP6-7.5-150 | 7.5 | 80 | 25 @ 150 psi | 150 | 3/4" | 53.6" x 28.9" x 60.7" | 925 |
| UP6-10-125 | 10 | 80 | 38 @ 125 psi | 125 | 3/4" | 53.6" x 28.9" x 60.7" | 925 |
| UP6-10-150 | 10 | 80 | 34 @ 150 psi | 150 | 3/4" | 53.6" x 28.9" x 60.7" | 925 |
| UP6-15c-125 | 15 | 80 | 55 @ 125 psi | 125 | 3/4" | 53.6" x 28.9" x 60.7" | 925 |
| UP6-15c-150 | 15 | 80 | 50 @ 150 psi | 150 | 3/4" | 53.6" x 28.9" x 60.7" | 925 |

Our 5-15HP UP Series rotary screw air compressors provide best-in-class performance in rotary screw technology. Each compressor package comes standard with 230 / 460-3-60 ODP electric motor, air-cooled aftercooler to reduce discharge air temperatures, full voltage motor starter that is mounted and wired (wired for 230-3-60 voltage standard), dual control (auto start and stop, constant speed control), low sound / full sheet metal enclosure, package pre-filter, 9,000-hour rated Ultra-Plus coolant, spin-on oil filter and separator element, A.S.M.E coded horizontal receiver tank with electric drain valve, and NEMA-1 electrical protection. These models operate at 64 to 69 dBA.

Recommended accessories:

- Installation kit (page 79)
- Maintenance kit (page 79)



Rotary Screw Air Compressors

UP Series 5-15 HP Total Air System

| Model | Running Power hp | Tank Capacity gal | Airflow acfm | Operating Pressure psi | Discharge Pressure psi | Air NPT Outlet in | Package Dimensions in | Net Weight lb |
|----------------|------------------|-------------------|----------------|------------------------|------------------------|-------------------|-----------------------|---------------|
| UP6-5TAS-125 | 5 | 80 | 18.5 @ 125 psi | 125 | 115 | 3/4" | 53.6" x 28.9" x 60.7" | 1,000 |
| UP6-5TAS-150 | 5 | 80 | 16 @ 150 psi | 150 | 140 | 3/4" | 53.6" x 28.9" x 60.7" | 1,000 |
| UP6-7.5TAS-125 | 7.5 | 80 | 28 @ 125 psi | 125 | 115 | 3/4" | 53.6" x 28.9" x 60.7" | 1,000 |
| UP6-7.5TAS-150 | 7.5 | 80 | 25 @ 150 psi | 150 | 140 | 3/4" | 53.6" x 28.9" x 60.7" | 1,000 |
| UP6-10TAS-125 | 10 | 80 | 38 @ 125 psi | 125 | 115 | 3/4" | 53.6" x 28.9" x 60.7" | 1,000 |
| UP6-10TAS-150 | 10 | 80 | 34 @ 150 psi | 150 | 140 | 3/4" | 53.6" x 28.9" x 60.7" | 1,000 |
| UP6-15cTAS-125 | 15 | 80 | 55 @ 125 psi | 125 | 115 | 3/4" | 53.6" x 28.9" x 60.7" | 1,000 |
| UP6-15cTAS-150 | 15 | 80 | 50 @ 150 psi | 150 | 140 | 3/4" | 53.6" x 28.9" x 60.7" | 1,000 |

Are you looking to save space and installation cost by having a complete clean, dry air system in a single package? The UP Series 5-15 HP Total Air System (TAS) is an innovative solution to your compressed air needs. The TAS has the same features and benefits of the standard UP Series 5-15HP unit, but also comes standard with an Energy Star cycling refrigerated air dryer with stainless steel heat exchanger, integrated compressor and dryer controls for optimum operation, panel-mounted dew point indicator, dual filters (general purpose and high-efficiency) mounted and piped, single-point condensate drain system with electric drain (115-volt), and high-efficiency moisture separator. These models operate at 64 to 69 dBA.

- Two coalescing filters: general purpose and high-efficiency
- Cycling refrigerated air dryer
- Pre-piped, single-point condensate drain system
- Eliminates up to 80 percent of traditional installation cost of individual air treatment equipment
- Intelligent design separates temperature-sensitive components and air treatment center on "cool side" from heat generating airennd on the "hot side"

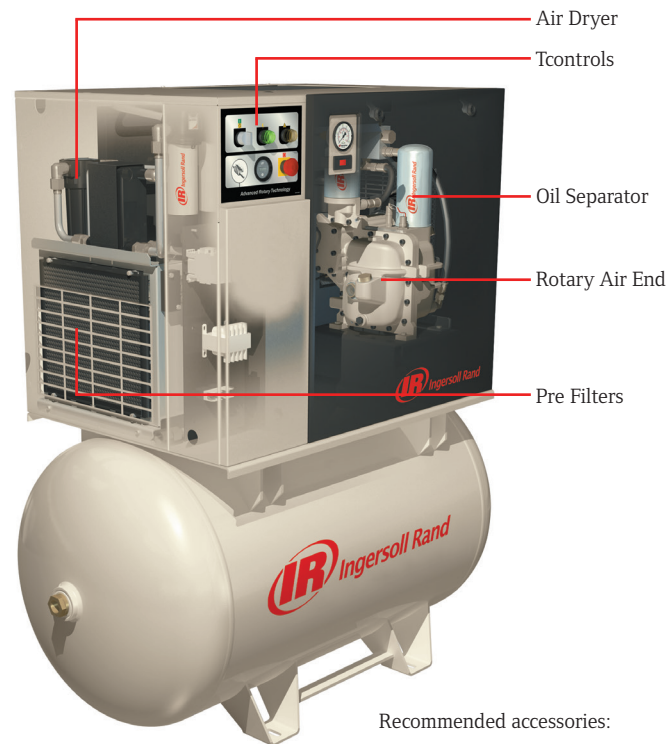

Recommended accessories:

- Installation kit (page 99)
- Maintenance kit (page 99)

Maintenance Kits



The competitively priced Maintenance Kit includes all parts required for every 3,000-hour or annual maintenance of your UP-Series rotary compressor. Ingersoll Rand air compressor accessories can be found on pages 63-66.

Refrigerated Dryers

Ingersoll Rand refrigerated air dryers protect your tools, machinery, and equipment from harmful moisture while saving energy and reducing system downtime. The unique design improves dryer efficiency and minimizes maintenance by using fewer moving parts. The easy-to-read diagnostic controls provide a constant indication of dryer performance. Units are compact, lightweight, and can be easily installed. Ingersoll Rand refrigerated air dryers are ideal for general industrial applications, and they use environmentally friendly refrigerants.

Protect your downstream equipment by preventing 100% saturated compressed air from rusting tools, and washing away lubricants with a refrigerated dryer. Ingersoll Rand's ISO class 6 refrigerated dryer can handle air flows from 7 to 212 SCFM. The dryer's corrosion resistant heat exchanger is reliable and operationally efficient with low pressure drop and optimized dewpoint performance. An enhanced refrigeration control-system and high-efficiency stainless steel moisture-separation ensure a steady long-term supply of dry air. A variable speed fan further ensures continuous heat removal. Simple controls provide user-friendly operation and a fully adjustable programmable electronic drain valve helps minimize air loss.

Enhance your system's protection by adding superior Ingersoll Rand air filters found on page 91. Continuous long-life operation from your refrigerated dryer is enhanced by installing a dryer pre-filter. Prior to the dryer use the recommended GP particulate filters. HE coalescing oil removal filters virtually eliminate cost due to ruined product finishes, scrapped materials or replacement of pneumatic tools and manufacturing equipment destroyed by contaminated air.



Sizing Table

Site conditions will affect the performance of your refrigerated dryer. Determine your site conditions and multiply the dryer capacity by each factor to determine the air flow that dryer is capable of.

| Dryer Inlet Air Temp °F | Correction Factor | Ambient Air Temp °F | Correction Factor | Inlet Pressure psig | Correction Factor |
|-------------------------|-------------------|---------------------|-------------------|---------------------|-------------------|
| 80 | 1.3 | 80 | 1.1 | 73 | 0.85 |
| 100 | 1 | 100 | 1 | 102 | 1 |
| 120 | 0.6 | 110 | 0.83 | 145 | 1.15 |
| 140 | 0.25 | 122 | 0.65 | 174 | 1.2 |
| NA | NA | NA | NA | 203 | 1.24 |

| Model | Capacity scfm | Nominal Power Consumption kW | Voltage | Connection size | in | | | Max Inlet Temp °F | Weight lb |
|--------|---------------|------------------------------|----------|-----------------|------|------|------|-------------------|-----------|
| D12IN | 7 | 0.16 | 115/1/60 | 1/2" | 12 | 16 | 16 | 140 | 40 |
| D18IN | 11 | 0.16 | 115/1/60 | 1/2" | 12 | 16 | 16 | 140 | 40 |
| D25IN | 15 | 0.16 | 115/1/60 | 1/2" | 12 | 16 | 16 | 140 | 40 |
| D42IN | 25 | 0.21 | 115/1/60 | 1/2" | 16 | 18 | 18 | 140 | 60 |
| D54IN | 32 | 0.37 | 115/1/60 | 1/2" | 16 | 18 | 18 | 140 | 62 |
| D72IN | 42 | 0.37 | 115/1/60 | 1/2" | 16 | 18 | 18 | 140 | 62 |
| D108IN | 64 | 0.48 | 115/1/60 | 1/2" | 16.5 | 21.5 | 22.5 | 140 | 77 |
| D144IN | 85 | 0.57 | 115/1/60 | 1/2" | 16.5 | 21.5 | 22.5 | 140 | 82 |
| D180IN | 106 | 0.71 | 115/1/60 | 1" | 16.5 | 21.5 | 22.5 | 140 | 104 |
| D300IN | 176 | 1.25 | 230/1/60 | 1-1/2" | 20 | 25.5 | 38.5 | 140 | 192 |
| D360IN | 212 | 1.25 | 230/1/60 | 1-1/2" | 20 | 25.5 | 38.5 | 140 | 192 |

Air Compressor Accessories

Electric Drain Valves (EDV)

Ingersoll Rand electric drain valves (EDV) are full-feature automatic electronic drain valves that deliver drier air by removing condensate from compressors, receivers, dryers, aftercoolers, filters, and drip legs.

Features / Benefits

- Extend life of pneumatic equipment and tools
- Eliminate manual draining
- Prevent rusting and clogging
- 2-year warranty
- Maximum 250 psi



| Voltage 110 / 120 V | Voltage 230 / 240 V | Inlet Pipe Connection | Outlet Pipe Connection | Orifice |
|-------------------------------|------------------------|--------------------------|---------------------------|---------|
| ELECTRONIC DRAIN VALVES (EDV) | | | | |
| 37995925 | 37995933 | 0.5 NPT | 0.25 NPT | 3/32" |
| 54410931 | 37995909 | 0.5 NPT | 0.25 NPT | 7/16" |
| 37995891 | 37995917 | 0.5 NPT | 0.5 NPT | 7/16" |
| 38000865 | 38000873 | 0.5 BSP | 0.25 BSP | 7/16" |
| 38000808 | 38000881 | 0.5 BSP | 0.5 BSP | 7/16" |
| 54579248* | 97339402 | JIC-14 | 0.25 NPT | 3/32" |

*JIC connection for field retrofits on T30 compressors.

| Part Number | Description |
|-------------------------------|---------------------------------------|
| ELECTRONIC DRAIN VALVES (EDV) | |
| 54381090 | 1/2" x 1/4" male NPT valve connection |
| 37996337 | 1/2" x 1/4" male NPT valve connection |
| 38000154 | Stainless steel filter screen |
| 54381090 | JIC — 14" x 1/4" NPT |

In-line Air Filters

Ingersoll Rand coalescing filters save energy and protect your tools, machinery, and equipment from harmful contaminants by effectively removing solid particulates, liquid water, oil, and aerosols from compressed air.

Unique in design, these in-line filters allow simple and fast maintenance with a patented zero-clearance element removal. Lighted indication ensures continued filtration performance. When it is time to replace the filter element, the lighted Element Change Indicator will illuminate with a rapid flash allowing your process to be continuously protected while minimizing the pressure drop in the compressed air system – saving you money.

Our general purpose filters remove particulates down to 1.0 micron, which meets general industry requirements for coarse filtration. Our high-efficiency filters remove contaminants down to 0.01 micron, which meets difficult compressed air filtration requirements.



| "G" General Purpose Filter Model* | "H" High-Efficiency Filter Model** | Flow Rating | Max Pressure psi | Inlet/Outlet NPT | Micron Rating | | Dimensions | |
|-----------------------------------|------------------------------------|-------------|------------------|------------------|---------------|------------|------------|-------|
| | | | | | "G" Models | "H" Models | H | W |
| F35IG | F35IH | 21 | 250 | 1/2" | 1 | 0.01 | 10.0" | 3.0" |
| F71IG | F71IH | 42 | 250 | 3/4" | 1 | 0.01 | 12.25" | 3.84" |
| F108IG | F108IH | 64 | 250 | 3/4" | 1 | 0.01 | 12.25" | 3.84" |
| F144IG | F144IH | 85 | 250 | 1" | 1 | 0.01 | 13.4" | 5.08" |
| F178IG | F178IH | 105 | 250 | 1" | 1 | 0.01 | 13.4" | 5.08" |
| F212IG | F212IH | 125 | 250 | 1" | 1 | 0.01 | 13.4" | 5.08" |
| F395IG | F395IH | 233 | 250 | 1-1/2" | 1 | 0.01 | 16.9" | 5.08" |
| F424IG | F424IH | 250 | 250 | 1-1/2" | 1 | 0.01 | 16.9" | 5.08" |

*G = General Purpose, 1 micron rating

** H = High Efficiency, 0.01 micron rating

| Replacement Element | Part Number |
|---|-------------|
| GENERAL PURPOSE REPLACEMENT FILTER ELEMENTS | |
| F35IG | 85565505 |
| F71IG | 85565547 |
| F108IG | 85565588 |
| F144IG | 85565620 |
| F178IG | 85565661 |
| F212IG | 85565703 |
| F395IG | 85565745 |
| F424IG | 85565786 |
| HIGH-EFFICIENCY REPLACEMENT FILTER ELEMENTS | |
| F35IH | 85565513 |
| F71IH | 85565554 |
| F108IH | 85565596 |
| F144IH | 85565638 |
| F178IH | 85565679 |
| F212IH | 85565711 |
| F395IH | 85565752 |
| F424IH | 85565794 |

Air Compressor Accessories

Start-up Kits for Air Compressors

Start-up kits include all the parts needed to maintain your compressor for one year, plus the added protection of extended warranty coverage. Kits include:

- All-Season Select® lubricant — a synthetic, all-temperature blend designed to increase efficiency, reduce wear, and prevent carbon build-up
- Replacement filter elements
- Engine oil and filters are also included in kits for gas-driven compressors
- 2-year extended warranty (pump only) based on use of All-Season Select lubricant included in kit



| Model | Part Number |
|-------------------------------------|-------------|
| ELECTRIC START-UP KITS | |
| SS3 | 97338099 |
| SS5 | 20100251 |
| 2000 | 20102877 |
| 2340, 2475 | 32305880 |
| 2545, 7100, 2545N7.5-PS, 7100E10-PS | 32305898 |

| Model | Make | Part Number |
|--------------------------|-------------------|-------------|
| GAS START-UP KITS | | |
| SS3J5.5GB-WB | Briggs & Stratton | 97338610 |
| SS3J5.5GH-WB | Honda | 97339501 |
| SS3J5.5GH-AS | Honda | 97339501 |
| 2475F11GH | Honda | 32312936 |
| 2475F11.5GKA | Kawasaki | 32498511 |
| 2475F12.5G | Kohler | 32305872 |
| 2475F13GH | Honda | 32312936 |
| 2475F14G | Kohler | 46821567 |



Start-up Kit for Gas-driven Air Compressors

Lubricants

All-Season Select Lubricant

All-Season Select lubricant is a synthetic, all-temperature blend designed to increase efficiency, reduce wear, and prevent carbon build-up. It performs four times longer than petroleum-based lubricants. Recommended 2,000 hours of service between lubricant change-out under normal operating conditions.



| Coolant / Lubricant | Base Stock | Viscosity Index | Hours | ISO Viscosity Grade | SAE Grade |
|---------------------|------------|-----------------|-------|---------------------|-----------|
| LUBRICANT | | | | | |
| All-Season Select | Diester | 128 | 2,000 | 68 / 150 | 20W40 |

| All-Season Select Lubricant | Quantity | Part Number |
|-----------------------------|---------------|-------------|
| LUBRICANT | | |
| Box of quarts | (12) 1 qt | 34836739 |
| Box of 1/2 liters | (6) 1/2 liter | 97338149 |

Rotary Start Up Kits and Accessories

| Part Number | Description |
|-----------------------------|--|
| ROTARY START-UP KITS | |
| 38339297 | UP6 5-15c |
| 38028577 | UP6 20-40 |
| ACCESSORIES | |
| 38342028 | Panel Filter: UP6 5-15c (4-Pack) |
| 38338463 | Electrical Installation Kit: 1-phase UP6 5-15c |
| 22469183 | Maintenance Kit: UP6 5-15c |
| 38335410 | Installation Kit: UP6 5-15c |

Maintenance Kits — TS and SS Series Compressors

Ingersoll Rand Type 30 maintenance kits offer all the parts necessary to perform annual factory-recommended maintenance on your Type 30 compressor. Conveniently packaged, the kits can save you 20 to 30 percent more than purchasing parts individually.

Features

- One fill of All-Season Select lubricant
- One replacement air filter element
- All replacement gaskets and O-rings required to clean and inspect valves
- Easy-off maintenance reminder sticker to track when next maintenance is due



Single-Stage Maintenance Kits

| Model | Valve / Gasket Kit | Ring / Gasket Kit | Bearing Kit | Air Filter | Overhaul Kit | Gasket Kit |
|---------------------|--------------------|-------------------|-------------|------------|--------------|------------|
| MAINTENANCE KITS | | | | | | |
| SS3 electric units | 97338107 | 97338115 | N/A | 70243712 | N/A | N/A |
| SS5 electric units | 20100277 | 20100285 | N/A | 32170979 | N/A | N/A |
| 2000 electric units | 20103081 | 20103099 | 20103107 | 32170979 | 22222053 | N/A |

Two-Stage Maintenance Kits

| Model | Maintenance Kit |
|-----------------------------|-----------------|
| COMPRESSOR MAINTENANCE KITS | |
| 2340 | 38485314 |
| 2475 | 38485330 |
| 2545 | 38485298 |
| 7100 | 38485322 |

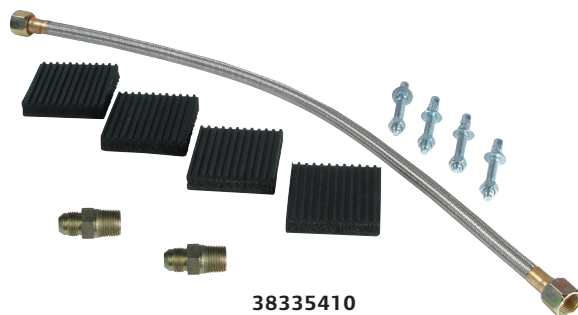

38335410

Installation Kits

| Kit Number | Description | Part Number | Quantity |
|---------------------------------|------------------------------|-------------|----------|
| 1/2" STANDARD INSTALLATION KITS | | | |
| 38335402* | Vibration pads | 32321002 | 4 |
| | 1/2" x 3' braided hose | 38335295 | 1 |
| | 1/2" JIC to NPT male adaptor | 38335337 | 2 |
| | 1/2" x 4" foundation bolts | 38335329 | 4 |
| | Instruction sheet | 22256549 | 1 |
| 3/4" STANDARD INSTALLATION KITS | | | |
| 38335410** | Vibration pads | 32321002 | 4 |
| | 3/4" x 3' braided hose | 38335303 | 1 |
| | 3/4" JIC to NPT male adaptor | 38335345 | 2 |
| | 1/2" x 4" foundation bolts | 38335329 | 4 |
| | Instruction sheet | 22256549 | 1 |
| 1" STANDARD INSTALLATION KITS | | | |
| 38335394 | 1" x 3' braided hose | 38335311 | 1 |
| | 1" JIC to NPT male adaptor | 38335352 | 2 |
| | 1/2" x 4" foundation bolts | 38335329 | 4 |
| | Instruction sheet | 22256549 | 1 |

*For compressor models SS3, SS5, 2340, and 2475 electric units.

**For compressor models 2475, 2545, and 7100 electric units.

Lubrication Equipment



Ingersoll Rand lubrication equipment reflects the same high standards of performance as Ingersoll Rand tools and air compressors, with a full range of products that will keep all types of fluids moving efficiently. They are backed by more than 70 years of experience in pump and air system technology, and include models specifically designed for popular applications.



ARO LM and LP Series Piston Pumps

Built Tough to Fit the Way You Work

Ingersoll Rand LM Series piston pumps deliver unmatched industrial-strength performance for pumping fluids with sizes to fit small (16 gal / 35 lb) or large (275 gal / 400 lb) containers. Working flow rates range from 2 to 6 gallons per minute. Pumps are offered from 3:1 to 50:1 ratios, in order to meet the requirements of any application. Our LM Series is ideal for pumping grease, motor oil, gear oil, or transmission fluid. The simple, durable design allows for piston pump service by any owner or qualified technician. Also look for our convenient grease and oil pump packages.

Features and Benefits

- Pump's patented design improves flow, reduces pulsation, and extends service life
- Offers simple self-service maintenance due to advanced design with 50% fewer parts
- Reduces service time, due to inline service design with no special tools required
- Features stall-free, ice-free air motor with tough, durable housing

Inline Service for 3:1 Piston Pumps

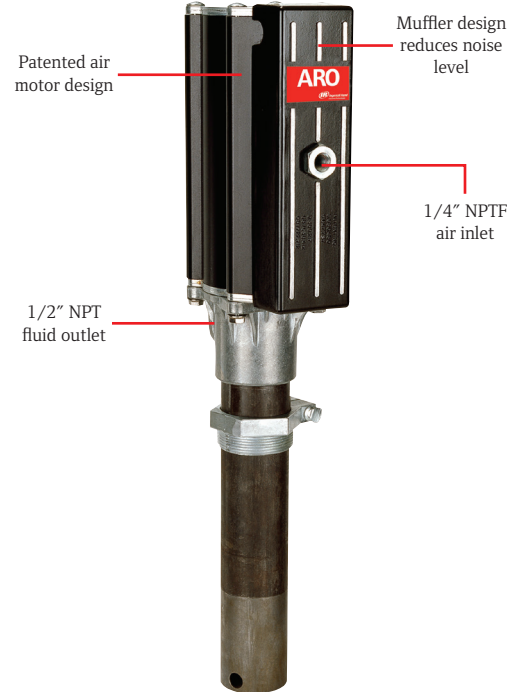
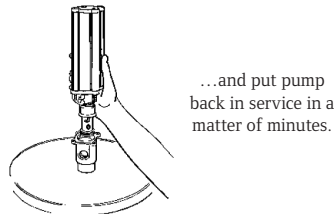
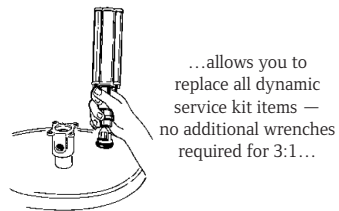
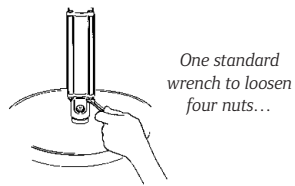

LM Series Piston Pumps

| Model | Working Flow gpm (L/min) | Free Flow gpm (L/min) | Fluid Inlet / Outlet NPTF in (mm) | Container gal | Air Inlet in (mm) |
|--------------------------|-----------------------------|--------------------------|--------------------------------------|------------------|----------------------|
| 3:1 PISTON PUMPS | | | | | |
| LM2203A-11-C | 6 (23) | 9 (34) | 3/4" / 1/2" (19 / 13) | Stub | 1/4" (6) |
| LM2203A-31-C | 6 (23) | 9 (34) | 3/4" / 1/2" (19 / 13) | 16 | 1/4" (6) |
| LM2203A-41-C | 6 (23) | 9 (34) | 3/4" / 1/2" (19 / 13) | 55 | 1/4" (6) |
| LM2203A-51-C | 6 (23) | 9 (34) | 3/4" / 1/2" (19 / 13) | 275 | 1/4" (6) |
| 5:1 PISTON PUMPS | | | | | |
| LM2305A-11-B | 6 (23) | 9 (34) | 1-1/2" / 1/2" (38 / 13) | Stub | 1/4" (6) |
| LM2305A-31-B | 6 (23) | 9 (34) | 1-1/2" / 1/2" (38 / 13) | 16 | 1/4" (6) |
| LM2305A-41-B | 6 (23) | 9 (34) | 1-1/2" / 1/2" (38 / 13) | 55 | 1/4" (6) |
| LM2305A-51-B | 6 (23) | 9 (34) | 1-1/2" / 1/2" (38 / 13) | 275 | 1/4" (6) |
| 50:1 PISTON PUMPS | | | | | |
| | ppm (kg/min) | ppm (kg/min) | Outlet NPTF in | Weight lb | |
| LM2250E-21-B | 2 (1) | 9 (4) | 3/8" | 35 | 1/4" (6) |
| LM2250E-31-B | 2 (1) | 9 (4) | 3/8" | 120 | 1/4" (6) |
| LM2250E-41-B | 2 (1) | 9 (4) | 3/8" | 400 | 1/4" (6) |
| LM2250E-61-B | 2 (1) | 9 (4) | 3/8" | 60 | 1/4" (6) |
| LM2350E-21-B | 4 (2) | 7.5 (3) | 3/8" | 35 | 1/4" (6) |
| LM2350E-31-B | 4 (2) | 7.5 (3) | 3/8" | 120 | 1/4" (6) |
| LM2350E-21-B | 4 (2) | 7.5 (3) | 3/8" | 400 | 1/4" (6) |
| LM2350E-21-B | 4 (2) | 7.5 (3) | 3/8" | 60 | 1/4" (6) |

LP Series Piston Pumps

| Model | Description | Pump | Meter | Control Handle | Dolly | Drum Cover | Hose | Valve | | | | |
|-----------------------------------|-------------------------------|--------------|----------|----------------|---------------|------------|-----------|-----------|-----------------|---------|----------|--------|
| PORTABLE OIL PUMP PACKAGES | | | | | | | | | | | | |
| LP2100-1-B | 3:1 ratio, 16 gal | LM2203A-31-C | 635190-1 | 635190-1 | 640058-2 | 94421 | 623501-6 | 67085 | | | | |
| LP3100-1-B | 5:1 ratio, 16 gal | LM2305A-31-C | 635190-1 | 635190-1 | 640058-2 | 94421 | 623501-6 | N/A | | | | |
| Model | Description | Pump | Meter | Handle | Control Dolly | Cover | Drum Hose | Plate | Follower Handle | Adaptor | Z-Swivel | |
| GREASE PUMP PACKAGES | | | | | | | | | | | | |
| LP2001-1-B | 2" diameter air motor, 35 lb | LM2250E-21-B | N/A | N/A | N/A | N/A | 94420 | N/A | 640095-2-B | 94434 | N/A | N/A |
| LP2002-1-B | 2" diameter air motor, 35 lb | LM2250E-21-B | N/A | 636111 | N/A | N/A | 94420 | 624201-10 | 640095-2-B | 94434 | 76493 | 636077 |
| LP2003-1-B | 2" diameter air motor, 120 lb | LM2250E-31-B | N/A | N/A | N/A | N/A | 94421 | N/A | 640165 | N/A | N/A | N/A |
| LP2004-1-B | 2" diameter air motor, 120 lb | LM2250E-31-B | N/A | 636111 | N/A | N/A | 94421 | 624201-10 | 640165 | N/A | 76493 | 636077 |
| LP2006-1-B | 2" diameter air motor, 120 lb | LM2250E-31-B | N/A | 636111 | 640058-2 | N/A | 94421 | 624201-10 | 640165 | N/A | 76493 | 636077 |
| LP3001-1 | 3" diameter air motor, 35 lb | LM2350E-21-B | N/A | 636103 | N/A | N/A | 94420 | 624201-10 | 640095-2-B | 94434 | 76493 | 636077 |
| LP3002-1 | 3" diameter air motor, 120 lb | LM2350E-31-B | 622201-3 | N/A | N/A | N/A | 94421 | 624401-4 | 640165 | N/A | N/A | N/A |
| LP3003-1 | 3" diameter air motor, 120 lb | LM2350E-31-B | N/A | 636103 | N/A | N/A | 94421 | 624401-4 | 640165 | N/A | 76493 | 636077 |
| LP3004-1 | 3" diameter air motor, 120 lb | LM2350E-31-B | N/A | 636111 | N/A | N/A | 94421 | 624401-4 | 640165 | N/A | 76493 | 636077 |
| LP3005-1 | 3" diameter air motor, 400 lb | LM2350E-41-B | 622201-3 | N/A | N/A | N/A | 94421 | 624401-4 | 640165 | N/A | N/A | N/A |
| LP3007-1 | 3" diameter air motor, 60 lb | LM2350E-61-B | N/A | 636111 | N/A | N/A | 71740-1 | 624401-4 | N/A | N/A | N/A | N/A |



LP3001-1



LP3003-1



LP3100-1-B

Piston Pumps

| Model | Working Flow gpm (L) | Free Flow gpm (L) | Air Inlet NPT (F) in | Fluid Outlet NPT (F) in | Container gal (L) | Accessories |
|---|-------------------------|----------------------|----------------------------|-------------------------------|----------------------|--------------|
| SERIES 200 PISTON PUMPS — 1:1 RATIO 2" DIAMETER AIR MOTOR | | | | | | |
| 612041-1 | 9 (34) | 18 (68) | 1/4" | 3/4" | 55 (208.2) | Bung adapter |
| 612041-3* | 9 (34) | 18 (68) | 1/4" | 3/4" | 55 (208.2) | Bung adapter |
| 612042-1 | 9 (34) | 18 (68) | 1/4" | 3/4" | 275 (1041) | Bung adapter |
| SERIES 425 PISTON PUMPS — 9:1 RATIO 4.25" DIAMETER AIR MOTOR | | | | | | |
| 662420-B* | 3.9 (14.8) | 21 (79.4) | 1/4" | 3/4" | Stub | N/A |
| 662409* | 3.9 (14.8) | 21 (79.4) | 1/4" | 3/4" | 16 (60.57) | N/A |
| 662410-B | 3.9 (14.8) | 21 (79.4) | 1/4" | 3/4" | 55 (208.2) | N/A |

*Not pictured.

PISTON PUMPS

Motor Oil, Gear Oil, and Transmission Fluid

612041-1

This 1:1 ratio pump is ideal for pumping motor oil, gear oil, and transmission fluid. This model fits a standard 55-gallon drum (including bung adapter).



612042-1

Our 1:1 ratio piston pumps are ideal for moving oils and fluids at high volumes. This model is designed for 275-gallon onboard tanks.



662410-B

425 Series pumps are designed with a 9:1 pump ratio, 1/4" air motor, and are ideal for pumping heavy oils over long distances.



ARO Diaphragm Pumps

Our diaphragm pumps are ideal for pumping oil or other light fluids such as anti-freeze, water, windshield fluid, fuel, solvents, transmission fluid, and waste oil. ARO diaphragm pumps range in size from 3/8" to 2" to meet the requirements of any application.

Features and Benefits

- Ideal for abrasion and solids handling
- From top to bottom, ARO's flap valve pump is your best high solids-handling choice
- Bolted construction for reliability and ease of assembly
 - Bolted is safer
 - Bolted is reliable
 - Bolted is easier to assemble
 - Bolted is less expensive
- Positive priming provides instant start-ups
- ARO's patented "unbalanced" air valve
 - Eliminates shifting / freezing problems
 - Uses significantly less power than competition
 - Does not require lubrication
 - Forgiving in dirty air
- Unstallable air motor design: SimulShift™
- Broad material selection
- Commitment — Ingersoll Rand diaphragm pumps come with a 5-year warranty.

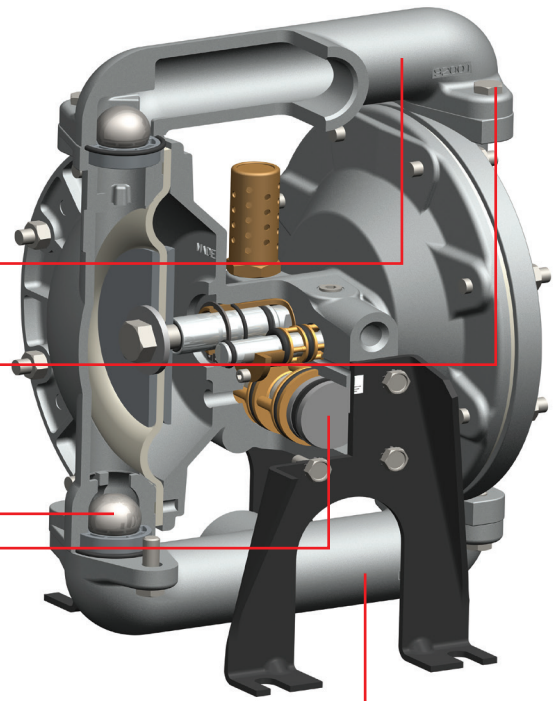

Diaphragm Pumps

| Model | Body Materials (Wetted) | Diaphragm / Ball Material | Air Inlet NPT (F) in | Fluid Inlet / Outlet Material in | Max Flow gpm | Compatible Fluids | Replaces Model |
|-------------------|-------------------------|---------------------------|----------------------|----------------------------------|--------------|---|----------------|
| 3/8" PORTS | | | | | | | |
| PD03P-ARS-PTT | Polypropylene | Teflon and anti-freeze | 1/4" | 3/8" | 10.6 | Windshield fluid, motor / gear oil, transmission fluid | New |
| PD03P-ARS-PCC | Polypropylene | Hytrel | 1/4" | 3/8" | 10.6 | windshield fluid, motor / gear oil, transmission fluid, anti-freeze | New |
| PD03P-AES-DTT | Acetal (groundable) | Teflon | 1/4" | 3/8" | 10.6 | Solvents | New |
| PD03P-AES-DCC | Acetal (groundable) | Hytrel | 1/4" | 3/8" | 10.6 | Windshield fluid, motor / gear oil, transmission fluid, anti-freeze | New |
| 1/2" PORTS | | | | | | | |
| PD05P-ARS-PTT-B | Polypropylene | Teflon | 1/4" | 1/2" | 14.4 | Windshield fluid, motor / gear oil, transmission fluid, anti-freeze | 66605J-344 |
| PD05P-ARS-PCC-B | Polypropylene | Hytrel | 1/4" | 1/2" | 14.4 | Windshield fluid, motor / gear oil, transmission fluid, anti-freeze | 66605J-322 |
| PD05P-ARS-PAA-B | Polypropylene | Santoprene | 1/4" | 1/2" | 14.4 | Windshield fluid / anti-freeze | 66605J-388 |
| PD05P-AES-DTT-B | Acetal | Teflon | 1/4" | 1/2" | 14.4 | | 666056-6A4 |
| PD05P-AES-DCC-B | Acetal | Hytrel | 1/4" | 1/2" | 14.4 | Windshield fluid, motor / gear oil, transmission fluid, anti-freeze | 66605H-622 |
| 66605J-344* | Polypropylene | Teflon | 1/4" | 1/2" | 13 | Windshield fluid, motor / gear oil, transmission fluid, anti-freeze | |

*These pumps have been superseded and will be discontinued in the near future. See recommended replacements above.

Diaphragm Pumps

| Model | Body Materials (Wetted) | Diaphragm / Ball Material | Air Inlet NPT (F) in | Fluid Inlet / Outlet Material in | Max Flow gpm | Compatible Fluids |
|---------------------|-------------------------|---------------------------|----------------------|----------------------------------|--------------|---|
| 1/2" PORTS | | | | | | |
| 66605J-322 | Polypropylene | Nitrile | 1/4" | 1/2" | 13 | Windshield fluid, motor / gear oil, transmission fluid, anti-freeze |
| 66605J-388 | Polypropylene | Polyurethane | 1/4" | 1/2" | 13 | Windshield fluid, motor / gear oil, transmission fluid, anti-freeze |
| 1" PORTS | | | | | | |
| 666100-344-C | Aluminum | Teflon | 1/4" | 1" | 35 | Windshield fluid, motor / gear oil, transmission fluid, anti-freeze, solvents |
| 666100-362-C | Aluminum | Nitrile / acetal | 1/4" | 1" | 35 | Windshield fluid, motor / gear oil, transmission fluid, anti-freeze |
| 666100-3C9-C | Aluminum | Hytrel | 1/4" | 1" | 35 | Windshield fluid, motor / gear oil, transmission fluid, anti-freeze |
| 666100-322-C | Aluminum | Buna | 1/4" | 1" | 35 | Windshield fluid, motor / gear oil, transmission fluid, anti-freeze |
| 650717-C | Aluminum | Viton / acetal | 1/4" | 1" | 29 | Fuel (UL 79 approved) |
| 1-1/2" PORTS | | | | | | |
| 666150-362-C | Aluminum | Nitrile / acetal | 1/2" | 1-1/2" | 90 | Windshield fluid, motor / gear oil, transmission fluid, anti-freeze |
| 650718-C | Aluminum | Viton / acetal | 1/2" | 1-1/2" | 75 | Fuel (UL 79 approved) |
| 2" PORTS | | | | | | |
| 666250-9C9-C | Aluminum | Hytrel | 3/4" | 2" | 172 | Windshield fluid, motor / gear oil, transmission fluid, anti-freeze |
| 650719-C | Aluminum | Viton / acetal | 3/4" | 2" | 105 | Fuel (UL 79 approved) |

650715-C

This 1:1 ratio pump has dual inlets to allow simultaneous pumping and blending of anti-freeze and water.



Specialty Application Pumps Specifications

| Model | Application | Manifold Material | Diaphragm and O-Ring Material | Air Inlet NPT (F) in (mm) | Fluid Outlet NPT / F in (mm) | Max gpm (L/min) | Package Includes |
|-------------------|------------------------------------|-------------------|-------------------------------|---------------------------|------------------------------|-----------------|--|
| 1/2" PORTS | | | | | | | |
| 612999-5 | Waste oil evacuation | Polypropylene | Nitrile | 1/4" (6) | 1/2" (13) | 11 (42) | Wall mount, inlet and outlet fluid hoses |
| 612999-6 | Waste oil evacuation | Polypropylene | Nitrile | 1/4" (6) | 1/2" (13) | 11 (42) | Hanging bracket and outlet hose |
| 1" PORTS | | | | | | | |
| 650715-C | 50/50 mix of anti-freeze and water | Aluminum | Nitrile | 1/4" (6) | 1" (25) | 35 (133) | Pump only |
| 612999-3 | 50/50 mix of anti-freeze and water | Aluminum | Nitrile | 1/4" (6) | 1" (25) | 35 (133) | Wall mount, siphon tubes, material hoses |
| 612999-4 | Waste oil evacuation | Aluminum | Nitrile | 1/4" (6) | 1" (25) | 35 (133) | Wall mount, inlet and outlet fluid hoses |
| 613201-2-C | Calcium chloride tire filling | Aluminum | Neoprene | 1/4" (6) | 1" (25) | 35 (133) | Inlet and outlet hoses, strainer, 8' suction hose, control handle, check valve |

Ingersoll Rand Heavy-duty Hose Reels

| Model | Performance Rating | Max Pressure | Hose Length ft | Hose ID in | Inlet / Outlet NPT | Dimensions (in) | | | Spool Material | Use |
|-------------------------|--------------------|--------------|----------------|------------|--------------------|-----------------|----------|-----------|----------------|---------------------------------|
| | | | | | | Length in | Width in | Height in | | |
| LOW-PRESSURE HOSE REELS | | | | | | | | | | |
| 6332 | Heavy-duty | 300 | 35' | 1/2" | 3/8" / 1/2" | 17.75" | 7" | 20.37" | Composite | Air, water, compatible solvents |
| 6358 | Heavy-duty | 300 | 50' | 3/8" | 3/8" / 3/8" | 17.75" | 7" | 20.37" | Composite | Air, water, compatible solvents |

6358

Hose Reel

Low-pressure

This composite hose reel provides excellent durability at a great value. All composite reels are made of a tough glass-filled material combined with a strong steel base.



Hose Reel Accessories

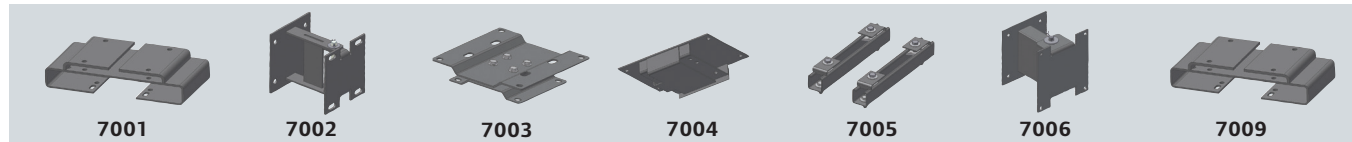

| Accessory | Model | Compatible With | Features |
|---|-------|-----------------------------|--|
| OH mounting bracket | 7001 | Ultra-duty | Overhead mounting bracket for I or H beam, 5" x 6" flange |
| OH mounting bracket | 7009 | Supreme-duty | Overhead mounting bracket for I or H beam, 8" x 9" flange |
| Wall-mount swing bracket | 7002 | Ultra-duty | Swing bracket (180°) for vertical mounting |
| Floor-mount swivel bracket | 7003 | Ultra-duty and supreme-duty | Swivel bracket (345°) for horizontal mounting |
| Ceiling-mount bracket, required with 7005 | 7004 | Ultra-duty | Easy installation bracket; reel slides in and out for easy overhead mounting; must be ordered with 7005 for I or H beam installation |
| I or H beam adapter, requires 7004 | 7005 | Ultra-duty | Easy installation bracket; I or H beam adapter; must be ordered with 7004. |
| Wall-mount swing bracket | 7006 | Supreme-duty | Vertical mounting bracket (180°); powdercoated crinkle black |
| Reelcraft adapter plate | 7007 | | Custom adapter bracket for Reelcraft 4000, 5000, 5806, and 7000 Series 3" x 5" and 4" x 5" base patterns |
| Graco adapter plate | 7008 | | Custom adapter bracket for Graco 500 Series 3" x 5" and 4" x 5" base patterns |

Control Handles

Non-metered Fluid Control Handles

| Model | Description | Max Working Pressure psi (bar) | Fluid Inlet NPT (F) in | Fluid Outlet |
|---|---|-----------------------------------|---------------------------|--------------|
| MOTOR OIL, GEAR OIL, TRANSMISSION FLUID | | | | |
| HIGH-VOLUME | | | | |
| 635193 | Has flexible rubber hose with a non-drip nozzle; use with 1:1 and 3:1 pumps; non-drip tip | 600 (41) | 3/4" | 71893 |
| 635395-2 | Has flexible rubber hose with non-drip nozzle; use with 5:1 and 9:1 pumps; non-drip tip | 900 (63) | 3/4" | 71893 |
| STANDARD-VOLUME | | | | |
| 635392 | Has flexible rubber hose, built-in swivel and filter, and non-drip nozzle; non-drip tip | 1,000 (69) | 1/2" | 60164 |
| 635399 | Has flexible rubber hose, built-in swivel, and right-angle non-drip nozzle; non-drip tip | 1,000 (69) | 1/2" | 70790 |
| WATER, ANTI-FREEZE | | | | |
| 635129 | Radiator bib | 300 (21) | 1/4" | Non-drip tip |



635193



635399



635392

Digital, Metered Fluid Control Handles

Our new metered control handle features a patented oval gear wheel design for precise reliable measurement. Its digital LCD readout operates on two standard alkaline batteries.

- Lightweight
- Precise
- Fast reset
- Totalizes

| Model | Max Flow Rate gpm (L) | Meter / Totalizing Increments | Max. Working Pressure psi (bar) | Fluid Inlet NPT (F) in | Fluid Outlet |
|--|--------------------------|----------------------------------|---------------------------------------|------------------------------|--------------|
| METERED, RIGID NOZZLE MODELS | | | | | |
| 635390-11 | 4 (15) | pt / gal | 1,000 (69) | 1/2" | Non-drip tip |
| 635390-22 | 4 (15) | qt / gal | 1,000 (69) | 1/2" | Non-drip tip |
| 635390-33 | 4 (15) | L / L | 1,000 (69) | 1/2" | Non-drip tip |
| NON-METERED, RIGID NOZZLE MODELS (HANDLE AND NOZZLE ONLY) | | | | | |
| 635391-11 | 4 (15) | N/A | 1,000 (69) | 1/2" | Non-drip tip |
| METERED, FLEXIBLE NOZZLE MODELS | | | | | |
| 635390-1 | 4 (15) | pt / gal | 1,000 (69) | 1/2" | Non-drip tip |
| 635390-2 | 4 (15) | qt / gal | 1,000 (69) | 1/2" | Non-drip tip |
| 635390-3 | 4 (15) | L / L | 1,000 (69) | 1/2" | Non-drip tip |
| NON-METERED, FLEXIBLE NOZZLE MODELS (HANDLE AND NOZZLE ONLY) | | | | | |
| 635391-1 | 4 (15) | N/A | 1,000 (69) | 1/2" | Non-drip tip |
| METER ONLY | | | | | |
| 635190-1 | 4 (15) | pt / gal | 1,000 (69) | 1/2" | |
| 635190-2 | 4 (15) | qt / gal | 1,000 (69) | 1/2" | |
| 635190-3 | 4 (15) | L / L | 1,000 (69) | 1/2" | |
| METER, CONTROL HANDLES (W/OUT NOZZLES) | | | | | |
| 635390-10 | 4 (15) | pt / gal | 1,000 (69) | 1/2" | |
| 635390-20 | 4 (15) | qt / gal | 1,000 (69) | 1/2" | |
| 635390-30 | 4 (15) | L / L | 1,000 (69) | 1/2" | |

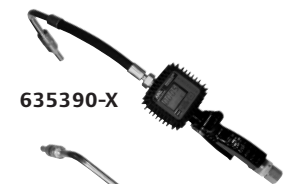

635390-X



635390-XX



635391-11



635391-1



635190-X

Order protective boot 74066 separately.

Metered Fluid Control Handles

| Model | Units of Measure | Totalizing Increments | Working Pressure psi | Inlet Size in | Fluid Outlet |
|---|-------------------------------------|-----------------------|----------------------|---------------|------------------------------|
| PRESET, DIGITAL METERED FLOW CONTROL | | | | | |
| Preset unit automatically shuts off when set quantity of fluid is delivered and meter indicator returns to zero. Totalizer registers up to 9,999 units. | | | | | |
| 635360-2 | Quarts | Gallons | 1,000 (69) | 1/2" | Non-drip flex extension |
| 635360-22 | Quarts | Gallons | 1,000 (69) | 1/2" | Non-drip rigid extension |
| 635360-3 | Liters | Liters | 1,000 (69) | 1/2" | Non-drip flex extension |
| 635360-33 | Liters | Liters | 1,000 (69) | 1/2" | Non-drip rigid extension |
| PRESET, METERED FLOW CONTROL | | | | | |
| Preset unit automatically shuts off when set quantity of fluid is delivered and meter indicator returns to zero. Totalizer registers up to 9,999 units. | | | | | |
| 635364 | Quarts, from 1 to 60 | Gallons | 1,000 (69) | 1/2" | Non-drip tip, 9/16" diameter |
| 635365 | Gallons, from 1 to 60 | Gallons | 1,000 (69) | 1/2" | Non-drip tip, 9/16" diameter |
| 635367 | Liters, from 1 to 60; auto shut off | Liters | 1,000 (69) | 1/2" | Non-drip tip, 9/16" diameter |



635360-2



635365

Non-drip Nozzle / Hose

| Model | Description | Fluid Inlet NPT (M) in | Length in (mm) | Max Working Pressure psi (bar) |
|---|-------------------------------------|------------------------|----------------|--------------------------------|
| MOTOR OIL, GEAR OIL, TRANSMISSION FLUID | | | | |
| 629212 | Non-drip nozzle / hose | 3/4" | 12" (305) | 900 (62) |
| 629226 | Non-drip nozzle / hose | 1/2" | 11" (279) | 900 (62) |
| 629516 | Non-drip nozzle / hose | 1/2" | 13" (330) | 1,000 (69) |
| 629521 | Right-angle nozzle / hose | 1/2" | 15" (381) | 1,000 (69) |
| 6786 | Right-angle, rigid, non-drip nozzle | 1/4" | 6-1/2" (165) | 1,000 (69) |
| 60798 | Rigid, non-drip nozzle | 1/2" | 5-1/2" (133) | 1,000 (69) |
| NOZZLE, FLEXIBLE HOSE, WITH NON-DRIP TIP | | | | |
| 629245-1 | Flexhose, non-drip tip | 1/2" | 15" (381) | 1,000 (69) |
| NOZZLE, RIGID TUBE, WITH NON-DRIP TIP | | | | |
| 629245-2 | Rigid tube, non-drip tip | 1/2" | 13" (330) | 1,000 (69) |



629226



629516



629521



6786

High-pressure Grease Control Handles

| Model | Description | Max Working Pressure psi (bar) | Fluid Inlet NPT (F) in | Fluid Outlet in |
|---|---|-----------------------------------|------------------------------|------------------------------------|
| GREASE CONTROL HANDLES | | | | |
| 636101 | Dispenses lubrication at line pressure for lubricating grease fittings. Does not include nozzle or hydraulic coupler. For applications requiring high-flow capacity. Remove the 1/8" (M) x 3/8" (M) adaptor for 3/8" (F) porting. | 7,500 (517) | 3/8" (F) | 11/16 – 16" (M) or 1/8" NPT (F) |
| 636111 | Dispenses lubricant at line pressure for lubricating grease fittings. Includes inlet material filter and curved nozzle with hydraulic coupler. Remove the 1/8" (M) x 3/8" (M) adaptor for 3/8" (F) porting. | 7,500 (517) | 1/8" (M) or 3/8" (F) | Hydraulic coupler |
| 636103 | High-pressure booster handle delivers line pressure for normal lubrication. Trigger booster feature delivers 10,000 psi (689 bar) to break loose tougher fittings. Includes curved nozzle with hydraulic coupler, inlet material filter and manual pressure vent for easy disconnection. WARNING: Do not use with whip hose. | 7,500 (517) | 1/8" (M) or 3/8" (F) | Hydraulic coupler |
| WHIP HOSES FOR GREASE CONTROL HANDLES* | | | | |
| 629742 | Extra-long, wire braid (624201-02) whip hose with hydraulic coupler and swivel. Overall length 29-1/2" (749 mm). For use with coupler 636111 high-pressure control handle. Allows operator to access hard-to-reach fittings. | 5,000 (345) | 1/8" (F) | hydraulic |

*WARNING: Not for use with 636103 high-pressure booster handle.



636101

636111

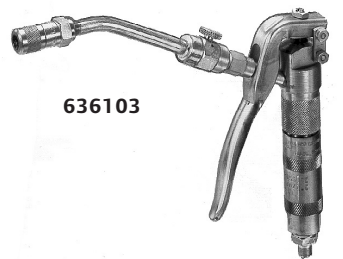

636103



629742

Water, Anti-freeze, Windshield Fluid Control Handle

| Model | Description |
|---|--|
| WATER, ANTI-FREEZE, WINDSHIELD FLUID | |
| 635129 | Fluid dispensing nozzle — 635129 bib with trigger 1/4" NPTF inlet, zinc die casting with brass and nitrile seals for water or oil service; radiator type bib has 1/4" fluid inlet and non-drip tip |



635129

Hand-operated Pumps

Grease NLGI #0 thru #3

| Model | Description |
|---|---|
| LUBRICATION PUMPS, 35-LB, DRUM COVER TYPE | |
| 611016 | Ball joint lubricator — Can deliver up to 1/4-oz of lubricant per stroke. Includes 72006 drum cover, 622511-10 hose assembly, 640095-3-B follower plate and 72806 booster control handle. Control handle capable of generating up to 7,500 psi. |



611016

Motor Oil, Gear Oil, Transmission Fluid

| Model | Ratio | Description |
|---|------------|--|
| MOTOR OIL, GEAR OIL, TRANSMISSION FLUID | | |
| 5-GAL | | |
| 611170 | Adjustable | Capable of high-volume delivery. Includes 621597-5 hose / dispensing, 2:1, 4:1, 7:1 nozzle assembly (5' (1.5 m), 1/2" ID hose) and 72006 drum cover. |



611170

Container not included.

Accessories



Ingersoll Rand offers an extensive line of accessories to match your tools with the requirements of every job. These accessories put the reliability and quality of Ingersoll Rand behind every job you do. For a comprehensive listing of all Ingersoll Rand accessories, please go to ingersollproducts.com/accessories

ARO Flo Series

For more than 100 years, Ingersoll Rand ARO has been an industry leader in the design and manufacture of compressors, pneumatic tools, and air preparation equipment. Clean air is a key ingredient that enables effective and efficient operation of tools, equipment, and machinery in almost every industry. As such, the use of air preparation devices, such as filters, regulators, and lubricators (FRLs) is an excellent means of keeping your air supply in top condition, as well as enabling your tools and equipment to operate at their peak performance. The new ARO-Flo Series FRLs continue the tradition of offering premium products for your operation, and also raises the bar in the industry for safety, flow performance, and modularity.

Filters

| Part Number | NPT in | Flow Rate scfm | Bowl Capacity oz | Bowl Type | Weight lb |
|-------------|--------|----------------|------------------|-----------------|-----------|
| FILTERS | | | | | |
| F35111-420 | 1/8" | 38 | 0.4 | Composite Nylon | 0.36 |
| F35121-420 | 1/4" | 49 | 0.4 | Composite Nylon | 0.36 |
| F35221-410 | 1/4" | 73 | 1.3 | Metal | 0.75 |
| F35331-410 | 3/8" | 107 | 1.3 | Metal | 1.44 |
| F35341-410 | 1/2" | 197 | 2.4 | Metal | 1.42 |
| F35451-410 | 3/4" | 288 | 5.3 | Poly | 2.77 |

Features

- Pipe sizes from 1/8" to 1" NPT
- Flows to 325 cfm
- Maximum inlet pressures to 250 psig



F35341-410

Lubricators

| Part Number | NPT in | Flow Rate scfm | Bowl Capacity oz | Bowl Type | Weight lb |
|-------------|--------|----------------|------------------|-----------------|-----------|
| LUBRICATORS | | | | | |
| L36111-120 | 1/8" | 32 | 0.7 | Composite Nylon | 0.38 |
| L36121-120 | 1/4" | 51 | 0.7 | Composite Nylon | 0.38 |
| L36221-110 | 1/4" | 51 | 1.5 | Metal | 0.74 |
| L36331-110 | 3/8" | 105 | 1.5 | Metal | 1.48 |
| L36341-110 | 1/2" | 156 | 3.7 | Metal | 1.46 |

Features

- Pipe sizes from 1/8" to 1" NPT
- Flows to 440 cfm
- Maximum inlet pressures to 250 psig



L36341-110

Regulators

| Part Number | NPT in | Flow Rate cfm | Adjusted Pressure Range psi | Weight lb |
|-------------|--------|---------------|-----------------------------|-----------|
| REGULATORS | | | | |
| R37111-600 | 1/8" | 45 | 0-140 | 0.43 |
| R37121-600 | 1/4" | 59 | 0-140 | 0.42 |
| R37221-600 | 1/4" | 86 | 0-140 | 0.87 |
| R37331-600 | 3/8" | 113 | 0-140 | 1.15 |
| R37341-600 | 1/2" | 210 | 0-140 | 1.19 |
| R37451-600 | 3/4" | 290 | 0-140 | 3.34 |

Features

- Pipe sizes from 1/8" to 1" NPT
- Flows to 491 cfm
- Maximum inlet pressures to 300 psig



R37-221-600

Accessories

| Part Number | Port Size (F) NPT in | Flow Rate cfm | Bowl Size oz | Weight lb |
|--------------------|----------------------|---------------|--------------|-----------|
| IN-LINE LUBRICATOR | | | | |
| L01-02-000 | 1/4" | 36 | 0.25 | 0.2 |
| L01-03-000 | 3/8" | 38.1 | 0.25 | 0.2 |



Features

- Assure proper lubrication for small pneumatic hand tools
- Oil capacity is 0.25 oz
- Requires cyclical or intermittent airflow for proper operation
- Cannot be filled under pressure

Piggyback Combination Over / Under Filters

| Part Number | NPT in | Flow Rate cfm | Bowl Size oz | Filter Element micron | Bowl Type | Adjusted Pressure Range psig | Weight lb |
|-------------------------------|-----------|---------------|--------------|-----------------------|-----------------|------------------------------|-----------|
| PIGGYBACK COMBINATION FILTERS | | | | | | | |
| P39114-620 | 1/8" mini | 13 | 1.1 | 20 | Composite nylon | 5 - 125 | 2.05 |
| P39124-620 | 1/4" mini | 13 | 1.1 | 40 | Composite nylon | 5 - 125 | 2.03 |
| P39224-610 | 1/4" | 93 | 6 | 40 | Metal | 5 - 125 | 2.05 |
| P39334-610 | 3/8" | 135 | 6 | 40 | Metal | 5 - 125 | 2.03 |
| P39344-610 | 1/2" | 140 | 6 | 40 | Metal | 5 - 125 | 2 |



Combination Filters

| Part Number | NPT in | Flow Rate cfm | Bowl Size oz | Filter Element micron | Bowl Type | Adjusted Pressure Range psig | Weight lb |
|---------------------|-----------|---------------|--------------|-----------------------|------------------------|------------------------------|-----------|
| COMBINATION FILTERS | | | | | | | |
| C38121-820 | 1/4" mini | 13 | 1.1 | 20 | Composite nylon | 5 - 125 | 1.2 |
| C38121-620 | 1/4" mini | 13 | 1.1 | 20 | Composite nylon | 5 - 125 | 1 |
| C38221-610 | 1/4" | 75 | 6 | 40 | Metal with sight glass | 5 - 125 | 5.48 |
| C38221-810 | 1/4" | 54 | 6 | 40 | Metal with sight glass | 5 - 125 | 6.98 |
| C38331-610 | 3/8" | 100 | 6 | 40 | Metal with sight glass | 5 - 125 | 5.43 |
| C38331-810 | 3/8" | 100 | 6 | 40 | Metal with sight glass | 5 - 125 | 6.35 |
| C38341-610 | 1/2" | 110 | 6 | 40 | Metal with sight glass | 5 - 125 | 6.38 |
| C38341-810 | 1/2" | 110 | 6 | 40 | Metal with sight glass | 5 - 125 | 6.69 |

Regulators / lubricators with gauge.



Accessories

Liquidator™ Filters / Dryers

| Part Number | NPT in | Description | Flow Rate cfm |
|-------------|--------|--|---------------|
| FILTERS | | | |
| TS-4000 | 1/2" | Liquidator tool saver | 60 |
| EAD-6000 | 1/2" | Liquidator prep station air dryer | 60 |
| PDS-2000 | 1/2" | Liquidator paint booth dessicant dryer | 25 |

| Part Number | Stage | Used In | Quantity |
|----------------------|-------------|----------|----------|
| REPLACEMENT ELEMENTS | | | |
| 8844-060 | One | EAD-6000 | 1 |
| 8844-060C | Two | EAD-6000 | 1 |
| 8844-460 | One | PDS-2000 | 1 |
| 8844-DES | Two | PDS-2000 | 1 |
| 8844-DES-6 | Two | PDS-2000 | 6 |
| 8844-060 | One and two | TS-4000 | 1 |

Features

- Centrifugal spinning
- Stainless steel media
- Friction drying and filtered air to one micron
- Inverse flow
- Automatic drain



Ingersoll Rand Lubricants

It goes without saying that proper lubrication of any tool is essential if you want the tool to last. By lubricating your air tools, you'll prolong the life of tool motors, governors, clutches, and other important impact mechanisms. Ingersoll Rand offers a complete line of specialized oils and greases to complement our full line of air tools.

Air Care Kits

| Part Number | Description |
|----------------------|--|
| AIR CARE KITS | |
| 67-LBK1 | Angle grinder care kit includes 10Z4 oil, 4 oz 67 grease, grease gun |
| 105-LBK1 | Metallic housings Impactool care kit includes 10Z4 oil, 4 oz 105 grease, grease gun |
| 115-LBK1 | Composite housings Impactool care kit includes 10Z4 oil, 4 oz 115 grease, grease gun |



105-LBK1

Air Tool Oils

| Part Number | Description | Size |
|----------------------|---|--------|
| AIR TOOL OILS | | |
| 63Z4 | #63 oil for Cyclone wick lubrication | 4 oz |
| 10Z4 | Class 1 #10 oils for use with percussive, assembly, Impactool | 4 oz |
| 10G | Class 1 #10 oils for use with percussive, assembly, Impactool | 1 gal |
| 10P | Class 1 #10 oils for use with percussive, assembly, Impactool | 1 pt |
| 10G55 | Class 1 #10 oils for use with percussive, assembly, Impactool | 55 gal |
| 50P | Class II lubricant, #50 oil for use with grinders, Impactool, hoists, winches | 1 pt |
| 50G | Class II lubricant, #50 oil for use with grinders, Impactool, hoists, winches | 1 gal |
| 62 1 Gal | Class II #62 oil for hoist and winch gear boxes | 1 gal |



10Z4



10G



10P



LUB-POP

Greases

| Part Number | Description | Grease # | Size |
|----------------|--|----------|-------|
| GREASES | | | |
| 23-1 LB | For the gearing of drills | 23 | 1 lb |
| 28 1 LB | For screwdriver gearing and clutches; drills, grinders, saws; tie tampers grease | 28 | 1 lb |
| 66 1 LB | For slow-speed, high-torque angle heads | 66 | 1 lb |
| 66 8 LB | For slow-speed, high-torque angle heads | 66 | 8 lb |
| 67-4T | For high-speed, high-temp angle heads (green) | 67 | 4 oz |
| 67-1 LB | For high-speed, high-temp angle heads (green) | 67 | 1 lb |
| 67 8 LB | For high-speed, high-temp angle heads (green) | 67 | 8 lb |
| 70 1 LB | For large piston motors and gear cases | 70 | 1 lb |
| 70 8 LB | For large piston motors and gear cases | 70 | 8 lb |
| 77-1 LB | For grinder angle heads | 77 | 1 lb |
| 80 1 LB | For bearings on sump pumps | 80 | 1 lb |
| 80 8 LB | For bearings on sump pumps | 80 | 8 lb |
| 90-14 oz | For gear heads and tube nut wrenches | 90 | 14 oz |
| 100 1 LB | Standard-duty Impactool grease | 100 | 1 lb |
| 100 8 LB | Standard-duty Impactool grease | 100 | 8 lb |
| 105-4T-6 | Metallic housing Impactool grease | 105 | 4 oz |
| 105-1 LB | Metallic housing Impactool grease | 105 | 1 lb |
| 105-8 LB | Metallic housing Impactool grease | 105 | 8 lb |
| 115-4T-6 | Composite housing Impactool grease | 115 | 4 oz |
| 115-1 LB | Composite housing Impactool grease | 115 | 1 lb |
| 150-1 LB | For impact mechanisms with swinging weight | 150 | 1 lb |
| 150-8 LB | For impact mechanisms with swinging weight | 150 | 8 lb |
| 170-1 LB | Premium impact grease for high temps, used with impact mechanisms | 170 | 1 lb |



100 1 LB



105-4T-6

Lubrication Kits

| Part Number | Description | Quantity |
|-------------------------|--|----------|
| LUBRICATION KITS | | |
| LUB-POP | Point-of-purchase display includes (3) 10G, (5) 10P, (24) 10Z4, (6) 100-1LB, (8) 105-LBK1, (8) 115-LBK1, (1) case 10Z4, (1) case hang tags | 1 |
| 10Z4-MB24 | Case of 10Z4; countertop display | 24 |
| 10P-MB5 | Case of 10P; countertop display | 5 |
| 10G-MB3 | Case of 10G; countertop display | 3 |
| 100-MB6 | Case of #100 grease; countertop display | 6 |
| 105LBK1-MB8 | Case of 105-LBK1; countertop display | 8 |
| 115LBK1-MB8 | Case of 115-LBK1; countertop display | 8 |

Grease Guns and Accessories

| Part Number | Description |
|----------------------------|---|
| GREASE GUNS | |
| P25-228 | Push-type hand grease gun for hydraulic-type fittings, holds up to 3 oz of grease |
| R000A2-228 | Push-type hand grease gun for flush-type fittings, holds up to 3 oz of grease |
| GREASE TUBE HEAD | |
| GTH-1 | Grease gun used with Ingersoll Rand 4 oz tube of grease |
| GREASE GUN COUPLERS | |
| 636020 | Grease gun coupler |
| 636024 | Grease gun adaptor |



P25-228



GTH-1



636020

MS Series Plugs and Couplers

INDUSTRIAL INTERCHANGE

- Economical automatic-type, one-way shutoff coupler
- Easy, push-to-connect use

| Body Size in | NPT or Hose Stem ID in | Average Flow cfm* | NPT Part Number | Hose Stem ID Part Number |
|---------------------|------------------------|-------------------|-----------------|--------------------------|
| FEMALE PLUGS | | | | |
| 1/4" | 1/8" | 36 | MSPF21 | N/A |
| 1/4" | 1/4" | 36 | MSPF22 | MSPH22 |
| 1/4" | 3/8" | 36 | MSPF23 | MSPH23 |
| 3/8" | 1/4" | 67 | MSPF32 | N/A |
| 3/8" | 3/8" | 67 | MSPF33 | MSPH33 |
| 3/8" | 1/2" | 67 | 45ATH | MSPH34 |
| 1/2" | 3/8" | 126 | MSPF43 | N/A |
| 1/2" | 1/2" | 126 | MSPF44 | MSPH44 |
| 1/2" | 3/4" | 126 | MSPF46 | N/A |
| MALE PLUGS | | | | |
| 1/4" | 1/8" | 36 | MSPM21 | N/A |
| 1/4" | 1/4" | 36 | MSPM22 | MSPH22 |
| 1/4" | 3/8" | 36 | MSPM23 | MSPH23 |
| 3/8" | 1/4" | 67 | MSPM32 | N/A |
| 3/8" | 3/8" | 67 | PRPM33 | MSPH33 |
| 3/8" | 1/2" | 67 | MSPM34 | MSPH34 |
| 1/2" | 3/8" | 126 | MSPM43 | N/A |
| 1/2" | 1/2" | 126 | MSPM44 | MSPH44 |

*At 90 psig inlet and 10 psig pressure drop.

Female Plugs



Female NPT



Hose Stem ID

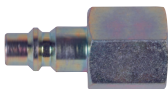

45ATH

Male Plugs



Male NPT



Hose Stem ID

| Body Size in | NPT or Hose Stem ID in | Average Flow cfm* | Manual NPT Part Number | Automatic NPT Part Number | Hose Stem ID Part Number |
|------------------------|------------------------|-------------------|------------------------|---------------------------|--------------------------|
| FEMALE COUPLERS | | | | | |
| 1/4" | 1/4" | 36 | N/A | MSCF22 | MSCH22 |
| 1/4" | 3/8" | 36 | N/A | MSCF23 | MSCH23 |
| 3/8" | 3/8" | 67 | 420ATH | MSCF33 | MSCH33 |
| 3/8" | 1/2" | 67 | 440ATH | N/A | N/A |
| 1/2" | 1/2" | 126 | N/A | MSCF44 | MSCH44 |
| MALE COUPLERS | | | | | |
| 1/4" | 1/4" | 36 | N/A | MSCM22 | MSCH22 |
| 1/4" | 3/8" | 36 | N/A | MSCM23 | MSCH23 |
| 3/8" | 1/4" | 67 | N/A | 4100ATH | N/A |
| 3/8" | 3/8" | 67 | 430ATH | MSCM33 | MSCH33 |
| 1/2" | 1/2" | 126 | N/A | MSCM44 | MSCH44 |

Female Couplers



Automatic NPT



Hose Stem ID



Manual NPT

Male Couplers



Automatic NPT



Hose Stem ID



4100ATH



430ATH

PR Series Plugs and Couplers

| Body Size in | NPT in | Average Flow cfm* | Part Number |
|-------------------------------|--------|-------------------|-------------|
| FEMALE THREAD COUPLERS | | | |
| 1/4" | 1/4" | 32 | PRSGF22 |
| 1/4" | 3/8" | 32 | PRSGF23 |
| 3/8" | 3/8" | 64 | PRSGF33 |
| 3/8" | 1/2" | 64 | PRSGF34 |
| 1/2" | 3/8" | 147 | PRSGF43 |
| 1/2" | 1/2" | 147 | PRSGF44 |
| 1/2" | 3/4" | 147 | PRSGF46 |
| MALE THREAD COUPLERS | | | |
| 1/4" | 1/4" | 32 | PRSGM22 |
| 1/4" | 3/8" | 32 | PRSGM23 |
| 3/8" | 3/8" | 64 | PRSGM33 |
| 3/8" | 1/2" | 64 | PRSGM34 |
| 1/2" | 3/8" | 147 | PRSGM43 |
| 1/2" | 1/2" | 147 | PRSGM44 |
| 1/2" | 3/4" | 147 | PRSGM46 |
| HOSE BARB COUPLERS | | | |
| 1/4" | 1/4" | 32 | PRSGH22 |
| 3/8" | 1/4" | 32 | PRSGH23 |
| 3/8" | 3/8" | 64 | PRSGH33 |
| 1/2" | 3/8" | 64 | PRSGH34 |
| 3/8" | 1/2" | 147 | PRSGH43 |
| 1/2" | 1/2" | 147 | PRSGH44 |
| 5/8" | 1/2" | 147 | PRSGH45 |
| 3/4" | 1/2" | 147 | PRSGH46 |

*At 90 psig inlet and 10 psig pressure drop.

QUICK CONNECT DOUBLE-ACTION COMPOSITE SAFETY COUPLERS

Couplers

- Made of non-marring composite
- Safety coupler eliminates accidental disconnects
- Easy connect, disconnect
- Allows you to bleed hoses
- Shockproof and crush-resistant



Female Thread Couplers



Hose Barb Couplers



Male Thread Couplers

| Body Size in | NPT in | Average Flow cfm* | Part Number |
|--------------------------------------|--------|-------------------|-------------|
| FEMALE THREAD CONNECTOR PLUGS | | | |
| 1/4" | 1/4" | N/A | PRPF22 |
| 1/4" | 3/8" | N/A | PRPF23 |
| 3/8" | 1/4" | N/A | PRPF32 |
| 3/8" | 3/8" | N/A | PRPF33 |
| 1/2" | 1/2" | N/A | PRPF44 |
| MALE THREAD CONNECTOR PLUGS | | | |
| 1/4" | 1/4" | N/A | PRPM22 |
| 1/4" | 3/8" | N/A | PRPM23 |
| 3/8" | 1/4" | N/A | PRPM32 |
| 3/8" | 3/8" | N/A | PRPM33 |
| HOSE BARB CONNECTOR PLUGS | | | |
| 1/4" | 1/4" | 32 | PRPH22 |
| 3/8" | 1/4" | 32 | PRPH23 |
| 3/8" | 3/8" | 64 | PRPH33 |
| 1/2" | 3/8" | 64 | PRPH34 |
| 1/2" | 1/2" | 147 | PRPH44 |
| 5/8" | 1/2" | 147 | PRPH45 |
| 3/4" | 1/2" | 147 | PRPH46 |

*At 90 psig inlet and 10 psig pressure drop.

Connector Plugs

- Carbonitride steel with anti-corrosion protection
- Teflon coating on all male threads



Female Thread Connector Plugs



Male Thread Connector Plugs



Hose Barb Connector Plugs

Air Hose Nipples

| Part Number | Hose Size in (mm) | Pipe Thread in |
|---------------------------|----------------------|-------------------|
| MALE PIPE THREAD | | |
| IR78217 | 1/4" (6) | 1/4" |
| IR30127 | 5/16" (8) | 1/4" |
| AL-387 | 5/16" (8) | 3/8" |
| R00-146 | 3/8" (10) | 1/8" |
| D01-14 | 3/8" (10) | 1/4" |
| IR6225 | 3/8" (10) | 3/8" |
| A01-46 | 1/2" (13) | 3/8" |
| D02-455 | 1/2" (13) | 1/2" |
| A03-46 | 3/4" (19) | 1/2" |
| J3-581 | 3/4" (19) | 3/4" |
| P35-46 | 1" (25) | 1" |
| CN-20-S | 2" (51) | 2" |
| FEMALE PIPE THREAD | | |
| R1-47 | 5/16" (8) | 3/8" |
| R00-147 | 3/8" (10) | 3/8" |

Male Pipe Thread



AL-387



R00-146

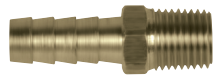

D01-14



IR6225



A01-46

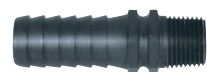

A03-46

Female Pipe Thread



R00-147

Swivels and Adapters

| Part Number | Thread Size in | Airflow cfm* | Description |
|--------------------------|-------------------|-----------------|-----------------------|
| SWIVEL-IT SWIVELS | | | |
| ASA-1/4 | 1/4" | 0 - 25 | Adjustable Swivel-It |
| ASC-1/4 | 1/4" | 0 - 33 | Non-marring Swivel-It |
| AS-3/8 | 3/8" | 0 - 45 | Standard Swivel-It |
| AS-1/2 | 1/2" | 0 - 65 | Standard Swivel-It |

| Part Number | Size NPT in | Description |
|-----------------------------|---|-----------------|
| SWIVELS AND ADAPTERS | | |
| 636077 | 1/8" (M) x 1/8" (F) | Z swivel |
| 636086-B | 1/4" (M) x 1/4" (F) | Z swivel |
| 636087-B | 1/4" (M) x 1/4" (F) with filter element | Z swivel |
| 635106 | 1/2" (F) x 3/8" (M) | Z swivel |
| 636075 | 1/8" (M) x 1/8" (F) | Straight swivel |
| 636085 | 3/8" (M) x 3/8" (F) | Straight swivel |
| 635117 | 1/2" (M) x 1/2" (F) | Straight swivel |
| 635108 | 3/4" (M) x 3/4" (F) | Straight swivel |
| 635107 | 3/8" (M) x 1/2" (F) | Straight swivel |
| 3249 | 1/8" (F) x 1/8" (F) | Female adapter |
| 676 | 1/8" (M) x 1/8" (M) | Male adapter |

Swivel-It Swivels



ASC-1/4

Swivels and Adapters



636077



636075



635108



676

Hose Whips

| Part Number | Hose ID in | Hose Length ft | Male End in | Female End in |
|--------------------|------------|----------------|-------------|---------------|
| HOSE WHIPS* | | | | |
| R00H-130 | 1/4" | 8' | 1/8" | 1/4" |
| R0-130 | 5/16" | 8' | 1/4" | 3/8" |
| R1A-130 | 3/8" | 8' | 1/4" | 3/8" |
| 510-130 | 3/8" | 8' | 3/8" | 3/8" |

*250 psig max working pressure.

Consists of hose assembled with male hose nipple at one end and female hose nipple at the other end.



Fitting Kits — Polyurethane Coil Hoses

| Part Number | Description |
|----------------------|--|
| FITTING KITS* | |
| P14-RMS | 1/4" NPT reusable male swivel fitting kit for 1/4" ID polyurethane hose |
| P38-RMS | 3/8" NPT reusable male swivel fitting kit for 3/8" ID polyurethane hose |
| P14-RMR | 1/4" NPT reusable male rigid fitting kit for 1/4" ID polyurethane hose |
| P38-RMR | 3/8" NPT reusable male rigid fitting kit for 3/8" ID polyurethane hose |
| P12-RFR | 1/2" NPT reusable female rigid fitting kit for 1/2" ID polyurethane hose |
| P12-RMS | 1/2" NPT reusable male rigid fitting kit for 1/2" ID polyurethane hose |

*125 psig working pressure @ 75° F.



P38-RMS



P12-RMS



P38-RMR

Premium Rubber Hose

| Part Number | Size |
|----------------------------|------------|
| PREMIUM RUBBER HOSE | |
| 38016820 | 3/8" x 50' |

- Premium rubber air hose, specifically designed for heavy-duty applications, such as industrial, maintenance, automotive, and/or construction
- 3/8" x 50' red hose with black Ingersoll Rand logo
- Black hose restrictors on each end provide a 300 psi working pressure and a 4:1 safety burst ratio

Polyurethane Coil Hoses

| Part Number | Description |
|--------------------------------|--|
| POLYURETHANE COIL HOSES | |
| P14-10 | 1/4" x 10' polyurethane coil hose, (1) 1/4" rigid, (1) 1/4" swivel fitting |
| P14-20 | 1/4" x 20' polyurethane coil hose, (1) 1/4" rigid, (1) 1/4" swivel fitting |
| P14-30 | 1/4" x 30' polyurethane coil hose, (1) 1/4" rigid, (1) 1/4" swivel fitting |
| P38-10 | 3/8" x 10' polyurethane coil hose, (1) 3/8" rigid, (1) 3/8" swivel fitting |
| P38-20 | 3/8" x 20' polyurethane coil hose, (1) 3/8" rigid, (1) 3/8" swivel fitting |
| P38-30 | 3/8" x 30' polyurethane coil hose, (1) 3/8" rigid, (1) 3/8" swivel fitting |
| P12-10R | 1/2" x 10' polyurethane coil hose, (2) 1/2" reusable swivel fittings |
| P12-20R | 1/2" x 20' polyurethane coil hose, (2) 1/2" reusable swivel fittings |
| P12-30R | 1/2" x 30' polyurethane coil hose, (2) 1/2" reusable swivel fittings |

Features

- Superior elasticity and coil memory mean a cleaner work environment
- Outstanding flexibility increases operator comfort
- 25% lighter than rubber hose, reducing operator fatigue
- Abrasion and kink resistance increase lifetime
- Tight coil diameter allows easy entry into confined spaces
- Non-marring surface won't harm work pieces
- Broad chemical resistance makes hoses suitable for most environments
- Better than 80% working length extends your work space
- Straight tails on both ends eliminate workstation tangles
- Reusable MNPT fittings allow field retrofits
- Thread sealant on all fittings provides for leak-free joints



Features

- 6-year warranty
- Longer life than PVC
- Reinforced innermost tube, resistant to the materials it is intended to convey
- Extended life bend restrictors
- Increased flexibility in cold temperatures
- Designed to withstand the harshest jobsite conditions
- Extended service life due to number of threads, spirals, and thickness of rubber tube



Spring Balancers

- 19 models to choose from
- Three different series to meet all balancing requirements
- Lifts ranging from 4-1/4' to 8.2'
- Covers weight balancing needs from 1 to 30 lb
- Made of rugged die-cast aluminum
- Safety locking device in case of spring breakage on medium-duty models
- Easy-to-use controls allow for accurate spring adjustment

Hose Reel Balancers

| Part Number | Hose Nipple Size in | Extended cfm | Capacity lb (kg) | Lift ft (mm) |
|----------------------------|---------------------|--------------|------------------------------|---------------|
| HOSE REEL BALANCERS | | | | |
| BHR-8 | 1/4" | 18.4 | 0.875 - 1.75 (0.397 - 0.794) | 4-1/4' (1295) |
| BHR-15 | 1/4" | 18.4 | 1.5 - 3.33 (0.68 - 1.51) | 4-1/4' (1295) |
| BHR-25 | 1/4" | 18.4 | 2.625 - 5.5 (1.191 - 2.495) | 4-1/4' (1295) |

Hose Reel Balancers



BHR-15

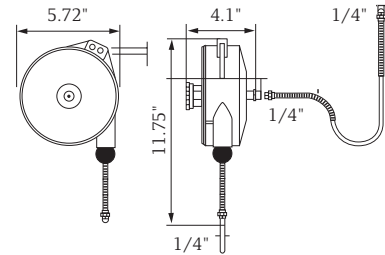

BHR Series

Light-duty Balancers

| Part Number | Capacity lb (kg) | Weight Of Balancer lb (net-kg) | Lift ft (mm) |
|---|---------------------|--------------------------------|--------------|
| LIGHT-DUTY BALANCERS — 0.9 - 6.6 LB CAPACITY | | | |
| BLD1 | 0.9 - 2.2 (0.4 - 1) | 1.3 (0.6) | 5.2' (1600) |
| BLD2 | 2.2 - 4.4 (1 - 2) | 1.3 (0.6) | 5.2' (1600) |
| BLD3 | 4.4 - 6.6 (2 - 3) | 1.3 (0.7) | 5.2' (1600) |

Light-duty Balancers



BLD1

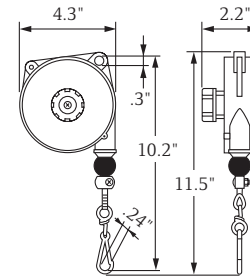

BLD Series

- Rotary hook
- Self-lubricating bushings
- Adjustable capacity and stroke limiting device
- Auxiliary safety suspension

Medium-duty Balancers

| Part Number | Capacity lb (kg) | Weight of Balancer lb (net-kg) | Lift ft (mm) |
|--|---------------------|--------------------------------|--------------|
| MEDIUM-DUTY BALANCERS* SHORT CABLES | | | |
| BMDS-2 | 2.2 - 5.5 (1 - 2.5) | 4.4 (2) | 6.5' (2000) |
| BMDS-4 | 4.4 - 8.8 (2 - 4) | 4.4 (2) | 6.5' (2000) |
| BMDS-6 | 8.8 - 13.2 (4 - 6) | 5.1 (2.3) | 6.5' (2000) |
| BMDS-8 | 13.2 - 17.6 (6 - 8) | 5.5 (2.5) | 6.5' (2000) |

Medium-duty Balancers



BMDS-2

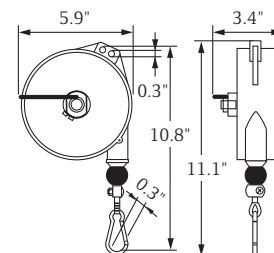

BMDS Series

| Part Number | Capacity lb (kg) | Weight of Balancer lb (net-kg) | Lift ft (mm) |
|--------------------|-----------------------|--------------------------------|--------------|
| LONG CABLES | | | |
| BMDLN-4 | 4.4 - 8.8 (2 - 4) | 6.4 (2.9) | 8.2' (2500) |
| BMDLN-6 | 8.8 - 13.2 (4 - 6) | 7.1 (3.2) | 8.2' (2500) |
| BMDLN-8 | 13.2 - 17.6 (6.8 - 8) | 7.7 (3.5) | 8.2' (2500) |
| BMDLN-10 | 17.6 - 22 (8 - 10) | 8.2 (3.7) | 8.2' (2500) |
| BMDLN-12 | 22 - 30 (10 - 14) | 8.8 (4) | 8.2' (2500) |

Medium-duty Locking Balancers



BMDLLN-10

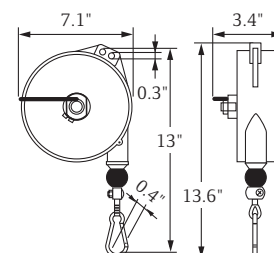

BMDLN / BMDLLN Series

| Part Number | Capacity lb (kg) | Weight of Balancer lb (net-kg) | Lift ft (mm) |
|---|---------------------|--------------------------------|--------------|
| MEDIUM-DUTY LOCKING BALANCERS* LONG CABLES | | | |
| BMDLLN-4 | 4.4 - 8.8 (2 - 4) | 6.6 (3) | 8.2' (2500) |
| BMDLLN-6 | 8.8 - 13.2 (4 - 6) | 7.3 (3.3) | 8.2' (2500) |
| BMDLLN-8 | 13.2 - 17.6 (6 - 8) | 7.9 (3.6) | 8.2' (2500) |
| BMDLLN-10 | 17.6 - 22 (8 - 10) | 8.4 (3.8) | 8.2' (2500) |

*Larger sizes available upon request.

Pullers and Hoists

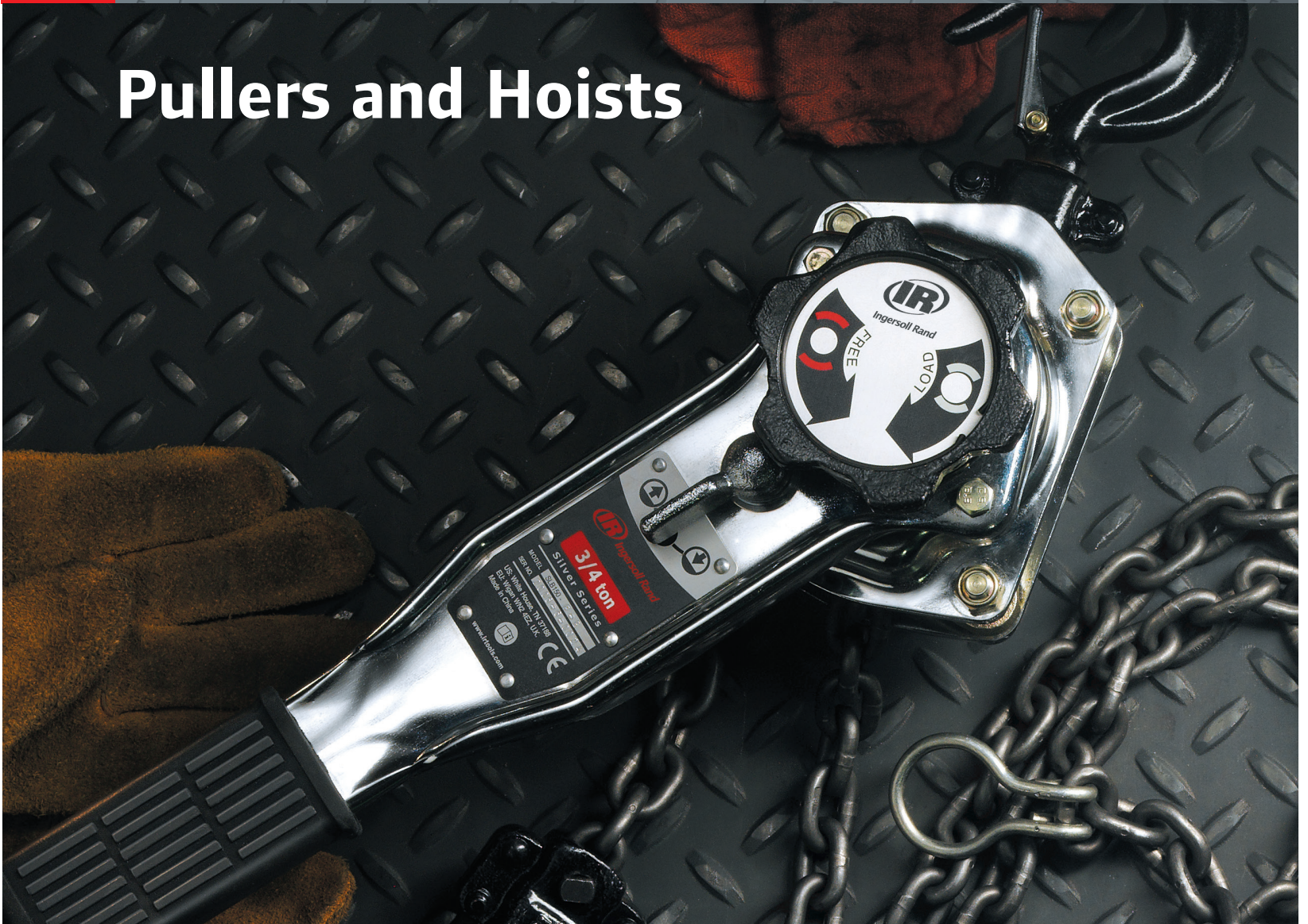

Ingersoll Rand pullers and hoists are designed to handle the tough pulling or lifting jobs, with minimal effort by the operator. Whether it's a low-, medium-, or heavy-duty job, you can trust our pullers and hoists to carry the load safely and easily.



P-Series Pullers

They'll pull up to 2,000 lb with no problem — and there's no hard work for you, either. Extremely strong and well-made, the Ingersoll Rand P-Series are high-quality, dependable wire rope pullers for low- and medium-duty pulling and lifting jobs.

- Made for superior strength with a steel frame and handle, alloy steel load hook, 1-piece cast aluminum drum, and solid steel drive and holding dog
- 4:1 design factor for lifting or pulling
- Long-lasting gears through the extra heavy Ingersoll Rand buttress tooth design

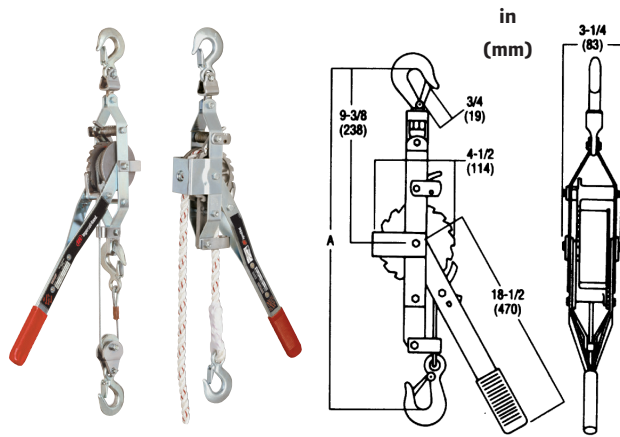

P-Series Pullers

C-Series Pullers

The C-Series includes rugged cast aluminum wire rope pullers designed to store more wire rope than all-steel ratchet pullers. With a rigged double line, they handle those long reach pulling or lifting jobs up to 3,400 lb with no problem.

- Extremely strong, with a solid cast steel drive and holding dog
- Heavy-duty cast aluminum drum and lightweight aluminum frame, alloy steel load hook with safety latches

Safe lowering is assured by the ratchet and pawl system. The gear teeth use the Ingersoll Rand buttress tooth design for additional strength and longer gear life.

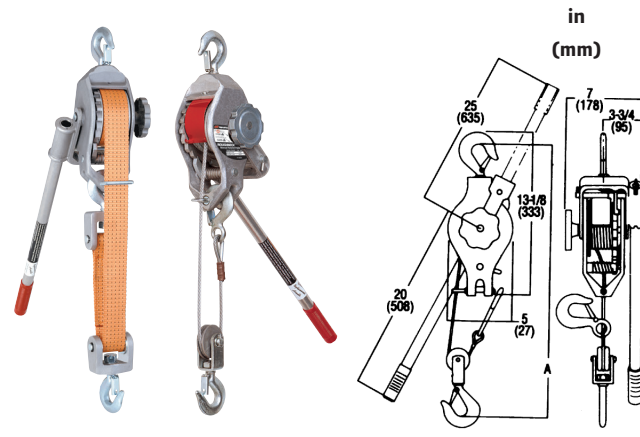

C-Series Pullers

| Model | Rated Number of Lines | Min Distance Capacity lb | Lifting Between Hooks in | Distance ft | Cable Diameter in | Net Number of Hooks | Weight lb |
|-------------------------|-----------------------|--------------------------|--------------------------|-------------|-------------------|---------------------|-----------|
| P-SERIES PULLERS | | | | | | | |
| P15HA | Single | 1,000 | 19.5" | 15' | 3/16" | 2 | 8.5 |
| P15D3HA | Single | 1,000 | 21" | 15' | 3/16" | 3 | 10.5 |
| | Double | 2,000 | 27.5" | 7-1/2' | 3/16" | 3 | 10.5 |
| C400HA | Single | 1,700 | 17" | 20' | 1/4" | 3 | 16 |
| | Double | 3,400 | 22" | 10' | 1/4" | 3 | 16 |
| C400SA | Single | 2,000 | 17" | 12' | 3/32" x 1-7/8" | 2 | 16 |
| | Double | 4,000 | 22" | 6' | 3/32" x 1-7/8" | 3 | 16 |

PT-8 Trolley Series

Plain 1/2 to 5 Metric Ton

Our plain trolley is rated for both manual or powered hoists, and has the versatility to fit most types of beams.

Standard features

- The 5:1 design factor allows the PT-8 Series to be used with both manual or powered hoists; meets pertinent U.S. (ASME / ANSI and CMAA), Canadian, and European standards
- The side plates, including the rail sweeps / drop stops, are made of cold-formed steel for strength, durability, and even load distribution
- The wheel axles are rivet-locked in place so they won't come loose — they are not knurled, welded, or modified bolts
- The wheels are cast iron — the universal tread fits both flat and tapered beams



Suspension bail is supplied with PT-8 trolleys only and is not required for most applications.

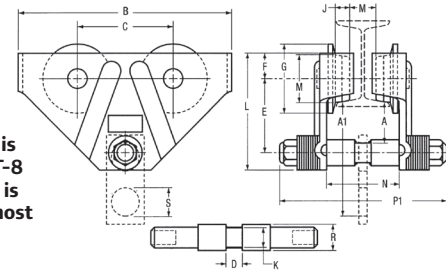

- Wheels run on sealed, "lubed-for-life" ball bearings; smoother rolling with less effort and less maintenance
- Wide hanger shaft assemblies allow PT-8 Series trolleys to fit almost any I beam, H beam, or patented track beam up to 8.06 in (205 mm) wide
- PT-8 Series trolley hanger shafts are designed to accept all hoist brands and have a squared out recess to accept round or squared hook shapes; the trolleys are painted black for universal coordination

| Model | Trolley Capacity lb (kg) | Fits Beam Flange Width in (mm) | Beam Height in (mm) | Curve Radius in (mm) | Net Weight lb (kg) |
|--|-----------------------------|-----------------------------------|------------------------|-------------------------|-----------------------|
| PT-8 TROLLEY CONTRACTOR SERIES — SINGLE 8" (205 MM) HANGER SHAFT | | | | | |
| PT005-8A | 1,100 (500) | 2.66" – 8.06" (68 – 205) | 4" (102) | 36" (914) | 20 (9) |
| PT010-8A | 2,200 (1000) | 3" – 8.06" (76 – 205) | 5" (127) | 36" (914) | 31 (14) |
| PT020-8A | 4,400 (2000) | 3.33" – 8.06" (85 – 205) | 6" (152) | 48" (1219) | 61 (28) |
| PT030-8A | 6,600 (3000) | 4" – 8.06" (102 – 205) | 7" (178) | 42" (1067) | 73 (33) |
| PT050-8A | 11,000 (5000) | 4.66" – 8.06" (118 – 205) | 8" (203) | 60" (1524) | 123 (56) |

| Model | A in (mm) | A1** in (mm) | B in (mm) | C in (mm) | D in (mm) | E in (mm) | F in (mm) | G in (mm) | H in (mm) |
|-------------------------|--------------|-----------------|---------------|--------------|--------------|--------------|--------------|--------------|--------------|
| PT-8 TROLLEY DIMENSIONS | | | | | | | | | |
| PT005-8A | 2.6" (66.0) | 5.9" (149.9) | 10" (254) | 4.5" (114.3) | 1" (25.4) | 4" (101.6) | 1.1" (27.9) | 3.5" (88.9) | 2.1" (53.3) |
| PT010-8A | 2.5" (63.5) | 5.9" (149.9) | 13" (330.2) | 5.2" (132.1) | 1.3" (33.0) | 4.4" (111.8) | 1.6" (40.6) | 4.2" (106.7) | 2.8" (71.1) |
| PT020-8A | 2.6" (66.0) | 6.1" (154.9) | 14.9" (378.5) | 6.8" (172.7) | 1.3" (33.0) | 5.3" (134.6) | 1.3" (33.0) | 5.8" (147.3) | 4.3" (109.2) |
| PT030-8A | 2.6" (66.0) | 7.9" (200.7) | 14" (355.6) | 6.4" (162.6) | 1.6" (40.6) | 5.5" (139.7) | 1.6" (40.6) | 5.8" (147.3) | 4.5" (114.3) |
| PT050-8A | 2.8" (71.1) | 8.1" (205.7) | 15.5" (393.7) | 7.1" (180.3) | 1.6" (40.6) | 5.8" (147.3) | 2.2" (55.9) | 6.2" (157.5) | 4.5" (114.3) |

| Model | J in (mm) | K in (mm) | L in (mm) | M* in (mm) | N* in (mm) | P1** in (mm) | R in (mm) | S in (mm) |
|-------------------------|--------------|--------------|--------------|---------------|---------------|-----------------|--------------|--------------|
| PT-8 TROLLEY DIMENSIONS | | | | | | | | |
| PPT005-8A | 0.8" (20.3) | 0.1" (2.54) | 6.6" (167.6) | - | 3.9" (99.1) | 12.3" (312.4) | 1.3" (33.0) | 1.6" (40.6) |
| PT010-8A | 0.8" (20.3) | 0.1" (2.54) | 6.6" (167.6) | - | 4.3" (109.2) | 12.9" (327.7) | 1.5" (38.1) | 1.6" (40.6) |
| PT020-8A | 1.1" (27.9) | 1.2" (30.5) | 7.5" (30.5) | - | 4.3" (109.2) | 13.8" (350.5) | 1.5" (38.1) | 1.6" (40.6) |
| PT030-8A | 1.1" (27.9) | 1.4" (35.6) | 8.6" (218.4) | - | 5.4" (137.2) | 14.1" (358.1) | 1.9" (48.3) | 2.6" (66.0) |
| PT050-8A | 1.6" (40.6) | 1.4" (35.6) | 9.8" (248.9) | - | 6.6" (167.6) | 15.6" (396.2) | 2.5" (63.5) | 2.6" (66.0) |

*Minimum dimension.

**Dimension for standard shaft length only.

Silver Series Lever Chain Hoists

3/4 to 6 Metric Ton Lifting Capacity

Meeting ANSI / ASME B30.16 and all pertinent world standards, the “-E” signifies compliance with Europe’s EC95 Machinery Directive.

The patent-pending, arrow-notch free-chain system is simple and reliable. Just one hand turns the indicator, and operators will enjoy the easiest free-chaining we have ever tested. Try to operate a Silver Series hoist in free-chain mode and the brake instantly engages, holding the load and minimizing the risk of an accident. Specify required lift in feet in the “L” position of model number.



Silver Series hoists have a zinc-nickel-chrome-plated finish. It’s more durable and corrosion-resistant than paint. Plus, the Silver Series has the quality features you expect from Ingersoll Rand.

- All-steel construction
- 360° handle rotation
- Rubber handle grip in all sizes
- Reliable disc brake
- Premium-grade alloy chain
- Hardened swivel-latch hooks
- Lightweight
- Low handle force
- Short handle stroke
- Standard lifts of 5, 10, 15, and 2

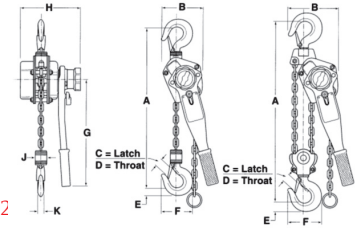

How to order

Specify required lift in feet in the “L” position of model number.

Example

SL150-15-A = 3/4 ton, with 15 feet of lift.

| Model | Rated Capacity | | Pull to Lift Rated Load lb | No. of Chain Falls | A mm (in) | B mm (in) | C mm (in) | D mm (in) | E mm (in) | F (min) mm (in) | Ø mm (in) | Load Chain Size (in) | |
|----------------------------|----------------|----------|----------------------------|--------------------|-----------|-----------|-----------|------------|-----------|-----------------|-----------|----------------------|---------------|
| | Metric tons | (lb) | | | | | | | | | | mm | (in) |
| SILVER SERIES CHAIN HOISTS | | | | | | | | | | | | | |
| SLB150-L-A | 3/4 | (1,650) | 41 | 1 | 158 (6.2) | 93 (3.6) | 132 (5.2) | 308 (12.1) | 29 (1.1) | 330 (13) | 37 (1.5) | 6 X 18 | (0.24 x 0.71) |
| SLB200 L-A | 1 | (2,200) | 60 | 1 | 163 (6.4) | 95 (3.7) | 140 (5.5) | 308 (12.1) | 32 (1.3) | 365 (14.4) | 40 (1.6) | 6 X 18 | (0.24 x 0.71) |
| SLB300 L-A | 1-1/2 | (3,300) | 53 | 1 | 185 (7.3) | 106 (4.2) | 145 (5.7) | 378 (14.9) | 35 (1.4) | 400 (15.7) | 45 (1.8) | 7.1 x 21.2 | (0.28 x 0.84) |
| SLB600 L-A | 3 | (6,600) | 53 | 1 | 212 (8.4) | 118 (4.6) | 199 (7.8) | 418 (16.5) | 44 (1.7) | 520 (20.5) | 55 (2.2) | 10 x 30 | (0.39 x 1.18) |
| SLB1200 L-A | 6 | (13,200) | 57 | 2 | 212 (8.4) | 118 (4.6) | 230 (9.1) | 418 (16.5) | 50 (2) | 640 (25.2) | 65 (2.6) | 10 x 30 | (0.39 x 1.18) |

SMB Manual Chain Hoists

Ingersoll Rand SMB Silver Series manual chain hoists offer the strength and durability you need in tough lifting situations. Their high-strength, all-stamped steel construction provides decreased weight and better impact resistance. In addition, the hoists feature roller bearings on input shafts and efficient gear reductions for easier lifting. Standard overload protection reduces downtime and repair costs resulting from abuse.

- Efficient gear reductions minimize hand chain overhauled to lift loads
- Encased and retained roller bearings for increased efficiency and ease of maintenance
- Single chain fall through 3 tons
- Nickel / chrome-plated exterior and zinc-plated frame components for increased corrosion resistance
- Double hand chain guides for smooth operation when pulling excess chain
- Open frame design for easy cleaning and inspection
- CE certified; hoists meet or exceed regional requirements including ASME B30.16, HST-2M
- Hardened swivel-latch hooks



Double load chain guides for proper load-chain tracking and smooth operation around load sheave.

Silver Series SMB manual chain hoists are ideal for these applications:

- Offshore drilling rigs
- Oil refineries and chemical plants
- Shipbuilding and shipyards
- Mining
- Utilities
- Steel mills and foundries
- General construction
- Maintenance and repairs
- Rigging

How to order:

Specify required lift in feet in the "L" position and hand chain length in feet in the "H" position.

Example:

10-8VA = 1/2 ton 10 ft lift, 8ft hand chain

| Model | Rated Capacity Metric Tons (lb) | No. of Chain Falls | Pull to Lift | | A in (mm) | B in (mm) | C in (mm) | D in (mm) | H (min) in (mm) | Load Chain Size in (mm) | Hoist Net Weight with 10' (3 m) Lift lb |
|--------|------------------------------------|--------------------|------------------|-----|--------------|--------------|--------------|--------------|--------------------|----------------------------|--|
| | | | Rated Load lb | lb | | | | | | | |
| SMB005 | 1/2 (1,100) | 1 | 55 | 55 | 5.2" (131) | 5.4" (137) | 1.1" (29) | 1.5" (37) | 12.8" (325) | 0.20" x 0.59" (5 X 15) | 23.5 |
| SMB010 | 1 (2,200) | 1 | 64 | 64 | 5.9" (151) | 6" (152.5) | 1.3" (32) | 1.6" (40) | 13.8" (350) | 0.24" x 0.71" (6 X 18) | 26.8 |
| SMB015 | 1-1/2 (3,300) | 1 | 69 | 69 | 7" (177) | 6.8" (173) | 1.4" (35) | 1.8" (45) | 17.1" (435) | 0.26" x 0.83" (7.1 x 21) | 38.5 |
| SMB020 | 2 (4,400) | 1 | 77 | 77 | 7.6" (192) | 6.9" (176) | 1.6" (40) | 2" (50) | 18.2" (463) | 0.31" x 0.94" (8 x 24.6) | 42.4 |
| SMB030 | 3 (6,600) | 1 | 100 | 100 | 9.4" (238) | 8.0" (204) | 1.7" (44) | 2.2" (55) | 20.9" (530) | 0.39" x 1.18" (10 x 30) | 70.4 |
| SMB050 | 5 (11,000) | 2 | 83 | 83 | 11.2" (285) | 7.4" (188) | 2" (50) | 2.6" (65) | 28" (710) | 0.35" x 1.06" (9 x 27.2) | 90.2 |

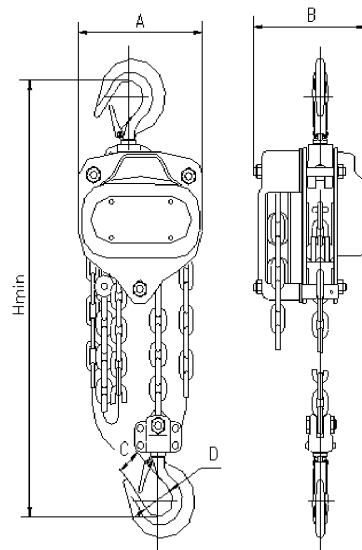

SMB005-030

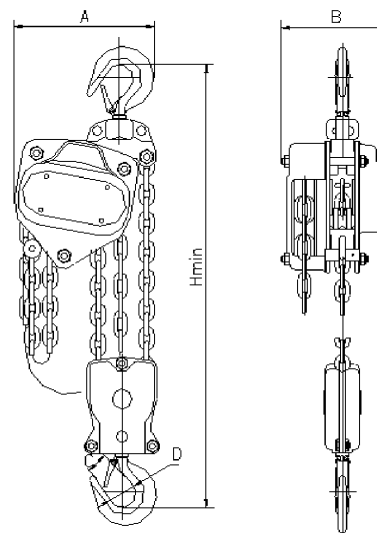

SMB050



Distributed by:



Ingersoll Rand Industrial Technologies provides products, services and solutions that enhance our customers' energy efficiency, productivity and operations. Our diverse and innovative products range from complete compressed air systems, tools and pumps to material and fluid handling systems. We also enhance productivity through solutions created by Club Car®, the global leader in golf and utility vehicles for businesses and individuals

(800) 376-TOOL • ingersollrandproducts.com