



ENGINEERED TO BE
FEARLESS

**INDUSTRIAL
AIR TOOLS
PRODUCT CATALOG**

WHY FEARLESS ENGINEERING MATTERS



It matters because you work on the toughest, harshest jobs, while under intense conditions and at these times you don't want any doubts or fears your tools might quit working.

Good news, you can be confident that our tools won't slow you down because we build them for safety, efficiency and longevity.

We take pride in our engineering; it matters to us that every detail inside and out is engineered to the exact specifications necessary for your application and industry to make working easier.

Just pick up a Sioux tool, and you'll be quick to notice the power-to-weight ratio, and how comfortable they are to hold and how easy they are to move around and manipulate. Know that today, and in the future, we're working to foresee any obstacles or conditions that would interfere with your goal of maximum productivity.

Ergonomics Matters

HIGH PERFORMANCE DRILLS

Engineering like this properly positions the index finger and hand up high on the drill without adding width to the tool. This makes getting into tight spots easy and provides maximum inline drilling pressure by letting the drill do the work for more comfort and performance. Soft insulated grip reduces cold and vibration.

Simplicity Matters

HASSLE FREE DROP-IN MOTORS

Engineering like this saves you time and money. No press fits or shims, just drop the motor in for quicker repair times. Less spare parts and fewer backup tools help cut inventory and costs.



Manufacturing Matters

FLEXIBILITY SOLVES PROBLEMS

Engineering like this allows us the flexibility to modify or adjust a tool for a specific issue.

Have a manufacturing problem? One of our Factory Trained Technical Sales Representatives will visit your facility to observe work and listen firsthand to the trouble you face.

This information will be shared with our Engineers in Murphy, NC. who will design, change or adjust a tool to solve the issue.



Productivity Matters

ENGINEERED FOR PERFORMANCE

- World Class Power-to-Weight Ratio
- Innovative Ergonomic Designs
- Power and Speed for High Productivity
- Built to be More Cost Effective
- 90% On Time Delivery



Durability Matters

ALL METAL GRINDERS

Engineering like this will stand-up under the toughest conditions; like snow, wind and freezing rain. No matter if they're dragged or bounced around, our all metal grinders are engineered to take it.



CATALOG INDEX

DRILLS	9
DRILLS	12 – 20
DRILL ACCESSORIES	21
ASSEMBLY	22
SCREWDRIVERS	27 – 33
NUTRUNNERS	34
RATCHET WRENCHES	35
IMPACT DRIVERS	37
IMPACT WRENCHES	38 – 40
ASSEMBLY ACCESSORIES	41
ABRASIVE	42
GRINDERS	44 – 53
TRIM SAW	54
MATERIAL REMOVAL TOOL	55
CUTOFF TOOLS	56 – 57
ABRASIVE ACCESSORIES	58
FINISHING	59
SANDERS	61 – 66
POLISHERS	67 – 68
FINISHING ACCESSORIES	69 – 70
PERCUSSIVE	71
SCALERS	73 – 74
HAMMERS	74
PERCUSSIVE ACCESSORIES	75 – 76
SPECIALTY	77
ROUTERS	79
CLINCH NUT TOOLS	81
TAPPERS	82
SKIN CLAMP RUNNERS	82
RIVET SHAVERS	83
SAWS	84
NIBBLERS & SHEARS	85
AEROSPACE	87 – 88
SPECIALTY ACCESSORIES	89 – 90
GENERAL ACCESSORIES	91 – 92

SIOUX TOOLS INDUSTRIAL CATALOG | MODEL NUMBER INDEX

MODEL	PAGE	MODEL	PAGE	MODEL	PAGE	MODEL	PAGE	MODEL	PAGE
1238L	67	GO459-80SRP	62	RO2512-60SRP	61	SC41011AL-K	74	SDGS1S25M6G	45
1285L	52	ID375AP-2Q	37	RO2512-60SVH	61	SC41011AL-N5	73	SDR10A10N3	19
1287L	65	ID375AP-2QRR	37	RO2512-60SVP	61	SC41011AU-C	73	SDR10A10N4	19
1290	66	IW1000MH-5S	40	RS10K	84	SC41011AU-N5	73	SDR10A10R3	19
1290L	66	IW1000MH-8H	40	RT1981	79	SC80910AL-C	73	SDR10A10R4	19
1291	53	IW1000MH-8H6	40	RT1982	79	SC80910AL-K	74	SDR10A13N2	19
1291L	53	IW1000MP-8H	40	RT1983	79	SC80910AL-N5	73	SDR10A13N3	19
1292	68	IW1000MP-8H5	40	RT1985	47	SCN12R	81	SDR10A16R2	19
1292L	68	IW1000MP-8H8	40	SAG03S12	48	SCN20R	81	SDR10A16R3	19
1296	68	IW150HAI-12H	40	SAG03S12M6S	48	SCN25R	81	SDR10A20R2	19
1300	84	IW150HAI-5S	40	SAG03S12M6S	48	SCN3R	81	SDR10A20R3	19
1464	20	IW150HAO-12H	40	SAG03S12S	48	SCN5R	81	SDR10A22N2	19
1465	20	IW150HAO-5S	40	SAG03S20	48	SCN7R	81	SDR10A22N3	19
1465-1/2	20	IW375AP-3F	37	SAG03S20M6	48	SCO10A106	56	SDR10A30N2	19
1466	20	IW375AP-3P	37	SAG03S20M6S	48	SCO10A125	56	SDR10A3R3	19
14S2500SR	76	IW38TBP-2Q	37	SAG03S20S	48	SCO10A184	56	SDR10A3R4	19
1670FRL	91	IW38TBP-3P	37	SAG05S12	48	SCO10AXL124	56	SDR10A4N3	19
1980	79	IW500MP-4F	38	SAG05S12M6	48	SCO10S184F	56	SDR10A4N4	19
1980A	79	IW500MP-4P3	38	SAG05S12M6S	48	SCO10S184R	56	SDR10A6R3	19
1981F	79	IW500MP-4PT	38	SAG05S12S	48	SCO10S204F	56	SDR10A6R4	19
1982A	79	IW500MP-4R	38	SAG05S15	48	SCO10S204R	56	SDR10P12N3	13
1985A	47	IW500MP-4R3	38	SAG05S15M6	48	SCO10S253F	56	SDR10P12N4	13
1985-1/2	47	IW500MP-7Q	38	SAG05S15M6S	48	SCO10S253R	56	SDR10P12NK3	13
1AM2101	33	IW75BP-6H	39	SAG05S15S	48	SCO7A184	56	SDR10P12R3	14
1AM2102	34	IW75BP-8H	39	SAG05S18	48	SCOA1AX124	57	SDR10P12R4	14
1AM2105	33	IW75OMP-6H	39	SAG05S18M6	48	SCOA1AX124G	57	SDR10P12RK4	14
1AM2106	34	IW75OMP-6P	39	SAG05S18M6S	48	SCOS1AX124	57	SDR10P16N3	13
1AM2201	33	IW75OMP-6PT	39	SAG05S18S	48	SCOS1AX124G	57	SDR10P16N4	13
1AM2205	33	IW75OMP-6R	39	SAG05S23	48	SDG03S25	44	SDR10P180N2	13
1OT2108Q	32	RO2510-44FNC	62	SAG05S23M6	48	SDG03S25M6	44	SDR10P20R2	14
1OT2208Q	32	RO2512-30FNH	61	SAG05S23M6S	48	SDG03S25M6S	44	SDR10P20R3	14
1OT2308Q	32	RO2512-30FNP	61	SAG05S23S	48	SDG03S25S	44	SDR10P20R3RR	15
1OT2508Q	32	RO2512-30FRH	61	SAG05S33	48, 64	SDG05S18	44	SDR10P20R4	14
1SM2103	28	RO2512-30FRP	61	SAG05S54	48, 64	SDG05S18M6	44	SDR10P20RK3	14
1SM2107	29	RO2512-30FVH	61	SAG10AX12	49	SDG05S18M6S	44	SDR10P20RK3R	15
1SM2105Q	31	RO2512-30FVP	61	SAG10AX12M6	49	SDG05S18S	44	SDR10P20RK4	14
1SM2205Q	31	RO2512-30SNH	61	SAG10AX15	49	SDG05S23	44	SDR10P20RK4R	15
1SM2305Q	31	RO2512-30SNP	61	SAG10AX15M6	49	SDG05S23M6	44	SDR10P210N2	13
1SM2405	31	RO2512-30SRH	61	SAG10AX18	49	SDG05S23M6S	44	SDR10P25R3	14
1SM2405Q	31	RO2512-30SRP	61	SAG10AX18M6	49	SDG05S23S	44	SDR10P25R3RR	15
1SM2407	29	RO2512-30SVH	61	SAG10S12	48	SDG10P18	63	SDR10P25R4RR	15
1ST2108Q	32	RO2512-30SVP	61	SAG10S12M6	48	SDG10P21	63	SDR10P25RK3	14
1ST2208Q	32	RO2512-35FNH	61	SAG10S15	48	SDG10S12F	44	SDR10P25RK3R	15
1ST2308Q	32	RO2512-35FNP	61	SAG10S15M6	48	SDG10S12MF	44	SDR10P25RK4R	15
1ST2508Q	32	RO2512-35FRH	61	SAG10S18	48	SDG10S12M6R	44	SDR10P26N2	13
270A	74	RO2512-35FRP	61	SAG10S18M6	48	SDG10S12R	44	SDR10P26N3	13
270A-2	74	RO2512-35FVH	61	SAG7AX13	49	SDG10S18F	44	SDR10P26N4	13
270A-4	74	RO2512-35FVP	61	SAG7AX13M6	49	SDG10S18MF	44	SDR10P26NK3	13
2S2300SR	82	RO2512-35SNH	61	SAG7AX16	49	SDG10S18M6R	44	SDR10P26NK4	13
AG16D106	52	RO2512-35SNP	61	SAG7AX16M6	49	SDG10S18R	44	SDR10P26NL4	13
AG16D1245	52	RO2512-35SRH	61	SAG7AX20	49	SDG10S25F	44	SDR10P3R3	14
AG16D125	52	RO2512-35SRP	61	SAG7AX20M6	49	SDG10S25MF	44	SDR10P3R4	14
AG22D847	52	RO2512-35SVH	61	SAG7S12	48	SDG10S25M6R	44	SDR10P3RK4	14
AS16S125	65	RO2512-35SVP	61	SAG7S12M6	48	SDG10S25R	44	SDR10P40N2	13
AS22S847	65	RO2512-50CNP	61	SAG7S15	48	SDG10SHT08	47	SDR10P40N3	13
3A1140	19	RO2512-50CNP	61	SAG7S15M6	48	SDG10SHT08M6	47	SDR10P40NK3	13
3A1240	19	RO2512-50CRH	61	SAG7S18	48	SDG10SHT12	47	SDR10P40R2	14
3A1530	19	RO2512-50CRP	61	SAG7S18M6	48	SDG10SHT12M6	47	SDR10P40R3	14
3A2102	34	RO2512-50CVH	61	SAGA1AX12	49	SDG7S18F	44	SDR10P40RK3	14
3A2104	34	RO2512-50CVP	61	SAGA1AX12G	49	SDG7S18MF	44	SDR10P4N3	13
3A2108	34	RO2512-50FNH	61	SAGA1AX12M6	49	SDG7S18FS	44	SDR10P4N4	13
3A2140	19	RO2512-50FNP	61	SAGA1AX12M6G	49	SDG7S25F	44	SDR10P4NK4	13
3A2208	34	RO2512-50FRH	61	SAGA1AX18	49	SDG7S25FS	44	SDR10P5R3	14
3A2240	19	RO2512-50FRP	61	SAGA1AX18G	49	SDG7S25MF	44	SDR10P5R4	14
3A2340	19	RO2512-50FVH	61	SAGA1AX18M6	49	SDGA1S12	45	SDR10P5R4RR	15
3A2430	19	RO2512-50FVP	61	SAGA1AX18M6G	49	SDGA1S12G	45	SDR10P5RK4	14
3P1140	13	RO2512-50SNH	61	SAP10A327	67	SDGA1S12M6	45	SDR10P60N2	13
3P1240	13	RO2512-50SNP	61	SAP10A457	67	SDGA1S12M6G	45	SDR10P60N3	13
3P1340	13	RO2512-50SRH	61	SAP10S227	67	SDGA1S18	45	SDR10P60NK3	13
3P1430	13	RO2512-50SRP	61	SAS03S122-20	64	SDGA1S18G	45	SDR10P7N3	13
3P1530	13	RO2512-50SVH	61	SAS03S202-20	64	SDGA1S18M6	45	SDR10P7N4	13
3P1540	13	RO2512-50SVP	61	SAS05S122-20	64	SDGA1S18M6G	45	SDR10P7NK4	13
3P1640	13	RO2512-60CNP	61	SAS05S152-20	64	SDGA1S25	45	SDR10P7R3	14
3T1140	20	RO2512-60CNP	61	SAS05S182-20	64	SDGA1S25G	45	SDR10P7R4	14
3T1340	20	RO2512-60CRH	61	SAS05S232-20	64	SDGA1S25M6	45	SDR10P7RK4	14
3T1530	20	RO2512-60CRP	61	SAS10A122-20	64	SDGA1S25M6G	45	SDR10P7RK4R	15
3T1630	20	RO2512-60CVH	61	SAS10A125	65	SDGS1S12	45	SDR10S12N3	16
3T1640	20	RO2512-60CVP	61	SAS10A152-20	64	SDGS1S12G	45	SDR10S12R3	16
3T2303	27	RO2512-60FNH	61	SAS10A182-20	64	SDGS1S12M6	45	SDR10S12R4	16
DR1467	20	RO2512-60FNP	61	SAS10A324	65	SDGS1S12M6G	45	SDR10S16N3	16
GO459-60SNH	62	RO2512-60FRH	61	SAS10A607	65	SDGS1S18	45	SDR10S180N2	16
GO459-60SNP	62	RO2512-60FRP	61	SAS10AX125	65	SDGS1S18G	45	SDR10S20R2	16
GO459-60SRH	62	RO2512-60FVH	61	SAS10S125	65	SDGS1S18M6	45	SDR10S20R3	16
GO459-60SRP	62	RO2512-60FVP	61	SAS10S905	65	SDGS1S18M6G	45	SDR10S20R4	16
GO459-80SNH	62	RO2512-60SNH	61	SAS10SX125	65	SDGS1S25	45	SDR10S210N2	16
GO459-80SNP	62	RO2512-60SNP	61	SASG10SX807N	65	SDGS1S25G	45	SDR10S25R2	16
GO459-80SRH	62	RO2512-60SRH	61	SC41011AL-C	73	SDGS1S25M6	45	SDR10S25R3	16

MODEL NUMBER INDEX | SIOUX TOOLS INDUSTRIAL CATALOG

MODEL	PAGE	MODEL	PAGE	MODEL	PAGE	MODEL	PAGE	MODEL	PAGE
SDR10S26N2	16	SDR4S30N2L	16	SRT10S25BB	79	SSD6P20SRR	28	SZEA9022	87
SDR10S26N3	16	SDR4S36N2L	16	SRT10S25LT	79	SSD6P25AC	30	SZEA9030	87
SDR10S3R3	16	SDR4S60N2L	16	SRT10S25M6B	79	SSD6P25P	27	VG40C606	53
SDR10S3R4	16	SDR5P12N2	12	SRT10S25M6N	79	SSD6P25PSRR	27	VG40D607	53
SDR10S40N2	16	SDR5P18R2	14	SRT10S25N	79	SSD6P25S	28	VG40D609	53
SDR10S40N3	16	SDR5P20R2	14	SRW03S-25	35	SSD6P7AC	30	VG40D807	53
SDR10S40R2	16	SDR5P230N2	12	SRW03S-38	35	SSD6P7S	28	VG50C606	53
SDR10S40R3	16	SDR5P24R2	14	SRW03S-38Q	35	SSH10P18	85	VG50D607	53
SDR10S4N3	16	SDR5P26N2	12	SRW07-38	35	SSH10S18	85	VG50D609	53
SDR10S4N4	16	SDR5P30N2	12	SRW07-50	35	SSR4P26	82	VG50D807	53
SDR10S5R3	16	SDR5P30R2	14	SSD10A10S	33	SSR6P25	82	VS40S607	66
SDR10S5R4	16	SDR5P33R2	14	SSD10A16S	33	STP10P3C20	82	VS40S609	66
SDR10S60N2	16	SDR5P36N2	12	SSD10A20S	33	STP10P3C32	82	VS40S807	66
SDR10S60N3	16	SDR5P3R2	14	SSD10A3S	33	STP10S12B12	82		
SDR10S7N3	16	SDR5P43N2	12	SSD10A5S	33	STP10S3B12	82		
SDR10S7R3	16	SDR5P50N2	12	SSD10A6S	33	STP10S5B12	82		
SDR10S7R4	16	SDR5P5N2	12	SSD10P12AC	30	STP10S7B12	82		
SDR10T12N4	20	SDR5P5R2	14	SSD10P12P	27	STXG10S12	46		
SDR10T16N4	20	SDR5P7N2	12	SSD10P12PS	27	STXG10S12M6	46		
SDR10T26N3	20	SDR5P8N2	12	SSD10P12S	28	STXG10S18	46		
SDR10T26N4	20	SDR5P8R2	14	SSD10P20AC	30	STXG10S18CW	46		
SDR10T4N4	20	SDR6P12N3	12	SSD10P20P	27	STXG10S18M6	46		
SDR10T40N3	20	SDR6P20R3	14	SSD10P20PRR	27	STXG10S23	46		
SDR10T7N4	20	SDR6P20R3RR	15	SSD10P20PS	27	STXG10S23M6	46		
SDR4A13H8L	17	SDR6P20RK3	14	SSD10P20S	28	STS10A124	54		
SDR4A18T8L	17	SDR6P20RK3RR	15	SSD10P20SRR	28	SWG05S183	50		
SDR4A20S8L	17	SDR6P20RK4RR	15	SSD10P25AC	30	SWG10A124	50		
SDR4A21F8L	17	SDR6P25R3RR	15	SSD10P25P	27	SWG10A1245	50		
SDR4A21H8L	17	SDR6P25RK3RR	15	SSD10P25PRR	27	SWG10A125	50		
SDR4A27S8L	17	SDR6P25RK4RR	15	SSD10P25PS	27	SWG10AX124	51		
SDR4A27S9L	17	SDR6P26N2	12	SSD10P25S	28	SWG10AX1245	51		
SDR4A28F8L	17	SDR6P26N3	12	SSD10P3AC	30	SWG10AX125	51		
SDR4A28F9L	17	SDR6P26N4	12	SSD10P3S	28	SWG10AXL124	51		
SDR4A28H8L	17	SDR6P26NK3	13	SSD10P5AC	30	SWG10S106	50		
SDR4A28C8L	17	SDR6P3N2	12	SSD10P5S	28	SWG10S124	50		
SDR4A28H8L	17	SDR6P40N2	12	SSD10P7AC	30	SWG10S1245	50		
SDR4A29T8L	17	SDR6P40N3	12	SSD10P7S	28	SWG10S125	50		
SDR4A33S8L	17	SDR6P40NK3	13	SSD10S12AC	31	SWG10S183	50		
SDR4A35F8L	17	SDR6P4N3	12	SSD10S12S	29	SWG10SX124	51		
SDR4A35C8L	17	SDR6P4N4	12	SSD10S20AC	31	SWG10SX1245	51		
SDR4A35H8L	17	SDR6P60N2	12	SSD10S20S	29	SWG10SX125	51		
SDR4A44S8L	17	SDR6P60N3	12	SSD10S25AC	31	SWG7AX134	51		
SDR4A47F8L	17	SDR6P60NK3	13	SSD10S25S	29	SWG7AX1345	51		
SDR4A47C8L	17	SDR6P7N3	12	SSD10S3AC	31	SWG7AX203	51		
SDR4A48T8L	17	SDR6P7N4	12	SSD10S3S	29	SWG7S183	50		
SDR4A55S8L	17	SDR6P7NK3	13	SSD10S5AC	31	SWG1AX124	51		
SDR4A57F8L	17	SDR6P7RK4RR	15	SSD10S5S	29	SWG1AX1245	51		
SDR4A57C8L	17	SMT05S354	55	SSD10S7AC	31	SWG1AX1245G	51		
SDR4A8F8L	17	SNH10S18	85	SSD10S7S	29	SWG1AX124G	51		
SDR4A8H8L	17	SNR10A10S	34	SSD4P11AC	30	SWG1AX124	51		
SDR4A8S8L	17	SNR10A16S	34	SSD4P11P	27	SWG1AX1245	51		
SDR4A8F-SRK	17	SNR10A20S	34	SSD4P11S	28	SWG1AX1245G	51		
SDR4A8S-SRK	17	SNR10A3S	34	SSD4P14AC	30	SWG1AX124G	51		
SDR4A8SF-SRK	17	SNR10A5S	34	SSD4P14P	27	SXG05S18	46		
SDR4P12N2	12	SNR10A6S	34	SSD4P14S	28	SXG05S18M6	46		
SDR4P18R2	14	SPS10P6	63	SSD4P18AC	30	SXG05S18M6S	46		
SDR4P20R2	14	SPS10P18	63	SSD4P18P	27	SXG05S18S	46		
SDR4P20R2RR	15	SRS10P21-10	83	SSD4P18PRR	27	SXG05S23	46		
SDR4P22N2	12	SRS10P21-5	83	SSD4P18S	28	SXG05S23M6	46		
SDR4P24R2	14	SRS10P21-6	83	SSD4P18SRR	28	SXG05S23M6S	46		
SDR4P26N2	12	SRS10P21-7	83	SSD4P26AC	30	SXG05S23S	46		
SDR4P26N3	12	SRS10P21-8	83	SSD4P26P	27	SZEA3000	88		
SDR4P26NK2	12	SRS10P21-9	83	SSD4P26PRR	27	SZEA3015	88		
SDR4P30N2	12	SRS10S21-8	83	SSD4P26S	28	SZEA5000	87		
SDR4P30NK2	12	SRS6P21-10	83	SSD4P26SRR	28	SZEA5015	87		
SDR4P30R2	14	SRS6P21-5	83	SSD4P5AC	30	SZEA5022	87		
SDR4P30R2RR	15	SRS6P21-6	83	SSD4P5P	27	SZEA5030	87		
SDR4P33R2	14	SRS6P21-7	83	SSD4P5S	28	SZEA6000	88		
SDR4P36N2	12	SRS6P21-8	83	SSD4P7AC	30	SZEA6015	88		
SDR4P3R2	14	SRS6P21-9	83	SSD4P7P	27	SZEA7000	87		
SDR4P43N2	12	SRS6P21-9W	83	SSD4P7S	28	SZEA7015	87		
SDR4P50N2	12	SRT10S18B	79	SSD6P12AC	30	SZEA7022	87		
SDR4P5N2	12	SRT10S18BB	79	SSD6P12P	27	SZEA7030	87		
SDR4P5N3	12	SRT10S18LT	79	SSD6P12S	28	SZEA7030HP	87		
SDR4P5R2	14	SRT10S18M6B	79	SSD6P20AC	30	SZEA8000	88		
SDR4P60N2	12	SRT10S18M6N	79	SSD6P20P	27	SZEA8015	88		
SDR4P8N2	12	SRT10S18N	79	SSD6P20PSRR	27	SZEA9000	87		
SDR4P8R2	14	SRT10S25B	79	SSD6P20S	28	SZEA9015	87		

Mission

To create and serve customers with quality products and service that meet or exceed their expectations.

History

A History of Success

Sioux Tools has a long and proud heritage of innovation as they have helped to shape the face of the tool industry. The company was started in November of 1914 by Swedish tool maker, Oscar Albertson, and office boy, Harold Jacobson, with a goal to become the “best machine and tool shop”. Sioux has since grown to become a trusted partner by a wide range of industrial and manufacturing segments.

Originally named Albertson & Company, the first items manufactured were piston rings, spark plugs and a gas saver. They soon expanded their line to become a powerful force in the marketplace. In early 1917, Oscar Albertson designed a valve lathe – a hand tool used to seat engine valves. This invention proved to be the foundation upon which Sioux Tools has built a reputation for innovation throughout the world.

During the 1920s the company revolutionized the tool industry by introducing some of the very first hand held power tools. In 1958 the company further solidified its position as a market leader by designing and producing its first air powered tools. Today, Sioux Tools has been granted well over 100 patents. Innovation, ingenuity and insight have established Sioux tools in the minds of the professional as the tool to depend on. Our commitment to continued development in ergonomics and innovative design ensures that we will meet the needs of professionals for many years to come.

Wherever there are markets for quality-built, reliable products, backed by strong after-sale dedication to customer satisfaction, you'll find Sioux Tools. Today we continue to strive to live up to our founding father's wish of being the “best in the world”.

In 1994 Sioux Tools joined Snap-on Incorporated, which added industrial power tools to the extensive Snap-on line. Snap-on Incorporated is a leading global developer, manufacturer and marketer of tool and equipment solutions for professional tool users. Product lines include hand and power tools, diagnostics and shop equipment, tool storage products, diagnostics software and other solutions for the transportation service, industrial, government, education, agricultural, and other commercial applications, including construction and electrical. Founded in 1920, Snap-on is a \$3+ billion, S&P 500 company headquartered in Kenosha, Wisconsin and employs approximately 14,000 worldwide.

Committed

Committed to your Success

For over 100 years, Sioux Tools has been providing tools that have been designed and built by the best engineers in the country. We use only top-quality materials in our manufacturing process, and we offer the strongest support and warranty in the business. Our over 100 patents are an indication of our innovation in product development and design.

Sioux Tools are built tough to provide you with many years of trouble-free service. But as with any piece of equipment, service problems can occur, thus Sioux tools are designed to make servicing quick, easy and affordable.

To help ensure fast repairs, which in turn limit downtime, Sioux Tools offers training seminars that cover all the details of the tools we make. For information on our training program, please contact your local Sioux Tools representative.

ISO/Warranty

Sioux Tool Power Tools Warranty

SIoux TOOLS WARRANTS TO THE ORIGINAL PURCHASER THAT THE COMPANY'S POWER TOOLS ARE FREE FROM DEFECTS IN MATERIALS AND WORKMANSHIP. For one (1) year following the date of purchase, Sioux Tools will repair or replace, at Sioux Tools' option, any part that is defective in materials or workmanship. All warranty requests or claims must be made no later than 60 days following the end of the 1-year warranty period. Repair or replacement shall be at the election and expense of Sioux Tools, and is the exclusive remedy in place of all other rights and remedies.



SIoux TOOLS INDUSTRIAL CATALOG

NO OTHER WARRANTIES, EXPRESS, IMPLIED OR STATUTORY, INCLUDING WITHOUT LIMITATION ANY IMPLIED WARRANTY OF MERCHANTABILITY OR FITNESS FOR A PARTICULAR PURPOSE, SHALL APPLY AND ALL SUCH WARRANTIES ARE HEREBY EXPRESSLY DISCLAIMED. Sioux Tools' warranty applies only to new products purchased from Sioux Tools or its authorized distributors. Sioux Tools does NOT provide warranty for products subjected to abnormal use.

Abnormal use includes: misuse, accident, modification, unreasonable use, neglect, lack of maintenance, or use after the tool is significantly worn or repaired by someone other than Sioux Tools or its Authorized Service Representatives.

A consumable product or part is warranted at the time of sale, only against defects in workmanship and materials that prevent its use. Consumable items are goods reasonably expected to be used up or damaged during use, including but not limited to drill bits, saw blades, grinding discs, sanding discs, batteries, and light bulbs.

SIoux TOOLS SHALL NOT BE LIABLE FOR ANY INCIDENTAL, SPECIAL, CONSEQUENTIAL COSTS OR DAMAGES INCURRED BY THE PURCHASER OR OTHERS (including, without limitation, lost profits, revenues, anticipated sales, business opportunities or goodwill, interruption of business and any other injury or damage.)

This warranty is non-transferable. Sioux Tools reserves the right to make changes in design and/or construction at any time without incurring any obligation related to tools previously sold.

ISO 9001

In 1997 Sioux Tools received its ISO 9001 certification. This certification is essential to doing business in today's global marketplace. It affirms our dedication to quality and our continued commitment to improvement. It assures our customers that the products they purchase will consistently live up to the promise of performance. It also validates our target goal of achieving maximum quality in every stage of the process - from the initial concept and development all the way through the delivery of spare parts. Our customers can be certain that Sioux tools will live up to their high expectations and provide a long, trouble-free life.



Industrial Tools

Sioux Tools is known around the world for quality, durability and performance. Our extensive and always expanding line of industrial power tools are engineered to make any job easier, safer and more efficient. We build tools that stand up to the demanding specifications required by today's industrial manufacturing, assembly and finishing needs. Our industrial line of tools is second to none in power, workmanship and total quality.

We Design Tools To Fit The Application

Sioux has been an innovator in designing tools that fill unique applications. The exclusive Z-handle design enables manufacturers to have a tool that will fit into extremely tight spaces yet maintain the full industrial power.

Research & Development

As new manufacturing techniques develop they bring with them new demands that may not be met with conventional air tools. Sioux Tools is ready to meet these needs by utilizing our engineering technology coupled with the latest innovations and technological advancements in the power tool industry.

We research the need to develop a new tool and then our Sioux team of engineers and designers go to work to produce the most efficient and versatile tool possible. We are constantly working to increase our product offering, but those new products must live up to our high expectations. Our extensive design engineering, research and development experience has proven our ability and commitment to build quality tools.

Continuous Quality Control

Every Sioux product undergoes rigorous performance tests at precise stages from design conception through product assembly and packaging to ensure they meet our own high standards and the demands of our customers. Only the finest materials are used in production, and no tool leaves our plant without thorough testing to meet Sioux quality standards. We've built our reputation on producing top-of-the-line industrial tools.

The Signature Series

Inspired by the operator, designed by Sioux Tools. Since 1914, Sioux Tools has been committed to bringing productive solutions to the pneumatic power tool industry.

Signature Series is an innovative pneumatic power tool program created through the implementation of next generation ergonomics, productivity enhanced features, value and accuracy.

Through industry research and operator input, we have engineered a program that truly delivers tools for the way you work!



Catalog Guide

Color-coded Tabs

Quick reference indicator to locate a particular section

Product Description

Instant reference to the type of tools displayed

Performance

Range of principle performance characteristics

Features

List of significant features common to all items

Specification Chart

Comparison chart of all models in this category including performance specifications and characteristics

General Info

Specifications that are common to all tools on the page

Standard Equipment

Listing of items that are included with purchase

Accessories

Shows what accessories are available or where to locate them in the catalog

Photos

Visual reference of selective models

ASSEMBLY | SIoux TOOLS INDUSTRIAL CATALOG

RIGHT ANGLE NUTRUNNERS

Performance:
Torque: 20 to 107 Nm
100 in lb (60 Nm)
Speed: 300 rpm - 2,000 rpm

Features:
Reversible
Lever Start
Rise and Side Exhaust

Right Angle Nutrunners

Model Number	Bolt Capacity ¹		Max Torque (Soft Joint)		Free Speed rpm	Weight		Length		Side To Center		Drive Size	
	in	mm	in lb	Nm		lb	kg	in	mm	in	mm		
Torque Control Clutch													
3A2104	3/8	M10	300	41	300	7.4	3.40	18.3	465	0.8	20	12	13
3A209F	3/8	M10	254	33	450	7.4	3.40	18.3	465	0.8	20	12	13
Adjustable Clutch													
1AM2106	1/2	M8.5	50	6.7	800	1.9	0.90	11.6	295	0.3	8	14	8
Soft Drive													
1AM2102	1/2	M8.5	50	6.7	800	1.5	0.70	11.5	292	0.3	8	14	8
Soft Drive													
3A2102	7/16	M11	400	68	300	6.2	2.81	17.8	452	0.8	20	12	13
3A2104F	7/16	M11	400	68	300	5.5	2.50	15.5	394	0.8	20	12	13
Soft Drive													
SNR10A05	3/8	M10	400	45.2	500	2.9	1.30	12.0	305	0.8	20	3/8	10
SNR10A05S	3/8	M10	325	36.7	600	2.9	1.30	12.0	305	0.8	20	3/8	10
SNR10A05S	3/8	M10	220	24.9	600	2.9	1.30	12.0	305	0.8	20	3/8	10
SNR10A05S	5/16	1/8	145	16.4	1000	2.9	1.30	12.0	305	0.8	20	3/8	10
SNR10A05S	1/2	3/8	40	6.0	1000	2.6	1.15	11.0	280	0.8	20	3/8	10
SNR10A05S	1/2	M8.5	58	6.6	2000	2.6	1.15	11.0	280	0.8	20	1/4	8

1. Metric capacities are based on: staggered assembly torques applied to SAE Grade 5 steel nuts. Class 9.8 fasteners under slightly lubricated conditions.
General: As 1 and Size: M7-N7 • Recommended Hole Size: M6 to min (1AM series), 3/16" (10 mm) (SNR), 3/8" series • Performance rated @ 90 psi (6.2 bar) at maximum.
Standard Equipment: Torq-Lok • Safety and Instruction Manual • Control Grip (1AM series) • Clutch Adjustment Wrench
Accessories: Nutrunners, Accessories... see page 41

WARNING SAFETY PRECAUTION: Read and follow all safety and operating instructions. **WARNING:** Face & eye protection must be worn while operating power tools, per ANSI B186.1

Safety Info

A brief reminder of safety when operating industrial power tools

Catalog Guide

Standard Equipment

Under this heading a specification is given for each type of tool and of the parts (nipples, keys, guards, etc.) supplied with the tool.

A parts list and safety and instruction manual are always included in the package with every tool.

Air Consumption

The air consumption of the tools is stated in cubic feet per minute (cfm) and liters per second, l/s, and relates to free air, i.e., the compressed air expanded to atmospheric pressure. Unless otherwise stated, the figures are valid at a working pressure of 90 psig (6.2 bar) and indicate the maximum air consumption unless otherwise stated.

Maximum air consumption for non-governed tools is achieved at free speed when the tool is running at no load. A tool with governed speed control has the maximum air consumption at the maximum power output.

Speed

The tool speeds are indicated in revolutions per minute, (rpm), and indicate the free speed, i.e., the speed at which the tool runs at no load and at a working pressure of 90 psig (6.2 bar), unless otherwise specified. The speed at maximum output is estimated as 50% of the idling speed for non-governed tools and 80-90% of the idling speed for tools with governed speed control.

Quick Conversion Chart

Length:

1 in	=	0.0254 m
1 m	=	39.3701 in
1 m	=	3.2808 ft
1 in	=	25.4 mm
1 ft	=	304.8 mm
1 mm	=	0.03937 in

Weight:

1 lb	=	0.4536 kg
1 kg	=	2.2046 lb

Torque:

1 kpm	=	9.8067 Nm
1 ft lb	=	1.3558 Nm
1 in lb	=	0.1130 Nm
1 Nm	=	0.1020 kpm
1 Nm	=	0.7376 ft lb

Model Number

Many tools have very similar performance characteristics. These subtle differences are often indicated by the addition of letters after the model number.

Weight and Length

The weight of the tools is listed in both pounds (lb) and kilograms (kg), and the length is listed in both inches (in) and millimeters (mm).

Side to Center

This measurement is taken from the center of the tool to the outside edge. It is useful for applications requiring the tool to fit into a precise or limited space.

Sound Level

In the field of ergonomics, sound level is very important to the safety and well-being of the operator. Sound levels are listed, where applicable, in decibels dB(A).

Pressure:

1 bar	=	100 kPa
1 kg/cm ² (at)	=	98.0665 kPa
1 psi	=	6.8948 kPa
1 kPa	=	0.145 psi
1 kPa	=	0.01 bar
1 kPa	=	0.0101972 kg/cm ² (at)

Power:

1 kgm/s	=	9.8067 w
1 hp	=	745.7 w
1 kw	=	101.972 kgm/s
1 kw	=	1.3410 hp

Flow:

1 m ³ /min	=	16.6667 l/s
1 cfm	=	0.4720 l/s
1 m ³ /h	=	0.2778 l/s
1 l/s	=	2.1189 cfm



DRILLS



Index	
Drills	12 – 20
Drill Accessories	21

DRILLS

Performance, Serviceability, Ergonomics and Value...



Light weight aluminum housing



Ergonomic, handle with soft textured grip



Available in 0.4 hp to 1.2 hp motor



3 planet gear system for increased life and load capacity



Teasing throttle, conveniently located reverse

Industry Leader

Regarded as the Number 1 choice in the industry, Sioux Tools' pneumatic drills are known around the world for their exceptional engineering and construction. A wide range of configurations, speeds, and options ensure a perfect match for any application. Through next generation ergonomics and the continued focus on productivity and operator safety comes the development of the Sioux Tools Signature Series Drill line.

Signature Series Drills are used in applications ranging from manufactured housing and wood working to light assembly. With free speeds from 300 to 16,000 rpm we have the right drill for any application, for use with any type of material. The powerful five vane motor makes these drills great for drilling applications that contain ferrous and non-ferrous metals, wood and composite materials. The Signature Series Drills offer great value with a 3 planet gear system for increased life and load capacity. The Sioux tools Signature Series Drill line reduces operator fatigue by offering a low sound level and low vibration solution! Operator comfort is achieved through the implementation of a light weight aluminum housing and a comfort grip. Drills are available in both reverse and non-reverse models and are available in pistol grip, straight, Z-handle and D and T-handles, and offer a variety of chuck and collet size.

Innovative Design

Our exclusive Z-handle models are often the only drills that will get you into those tough, hard to reach spaces, and our miniature aircraft angle drills are designed with small, compact 45° and 90° heads and internal threaded spindles that accept a variety of aircraft precision drill bits.

360° Rotation

The SDR10S40N360 has a unique 360° rotating head for applications in hard to reach places or difficult angles.

T-Handles

Our exceptional T-handle drills help reduce stress on the operators back and arms while making short work of any decking application.

Ergonomics

All Sioux Drills offer ergonomic features to provide maximum comfort during operation. Many models include comfortable insulating grips to reduce cold and vibration. We also offer optional support handles for most models.

Drill Maintenance



- 1 Tipper valve and valve seat is easily accessible for service
- 2 Slip fit of front end plate bearing allows easy service of the air motor without disturbing the rotor spacing
- 3 Drop in motor. No alignment necessary (applies to non-reversing drills only)
- 4 Rotor pinion is case hardened to resist wear
- 5 Grease zerk makes it easy to grease the gears without disassembly
- 6 Planetary reduction can be serviced without removing the chuck
- 7 Planet gear pins are slip fit for ease of assembly and disassembly
- 8 Ring gear is machined into the motor retainer for ease of assembly and disassembly
- 9 Interchangeable rotor, cylinder, bearings and end plates. This reduces the number of spare parts tool cribs need to stock

Accessories

Sioux carries an extensive selection of drill accessories, including hole saws and wire brushes.

See the drill accessory section in this catalog for a comprehensive listing.

Drill Safety

Chips can cause eye injury.

Drilling creates chips. Proper eye protection must be worn at all times by tool user and bystanders.

Broken drill bits can cause eye injury.

Proper eye protection must be worn at all times by tool user and bystanders.

Sudden and unexpected tool movement can cause injury.

Be sure your body position allows you to have control of the tool at all times. Make sure your footing is secure.

Tools starting unexpectedly can cause injury.

Always remove tool from air supply and activate trigger to bleed air line before making any adjustments, changing accessories, or doing any maintenance or service on the tool.

Drill Principles of Operation

An air motor and reduction gearing are used to drive a spindle / drill chuck, which holds accessories for drilling, reaming, tapping, and hole sawing. Motor size (horsepower), gear ratio, handle style and drive spindle determine the type of tool needed to handle an application.

Drill Uses

Pneumatic drills may first be thought of for drilling holes in wood, metal, or plastic. Drills are used in a wide variety of applications. Each of these applications require the proper tool with the proper horsepower and speed to get the best results. Drilling – cutting a hole in material using a fluted bit. Reaming – opening up or sizing a previously drilled hole or aligning offset holes. Tapping – cutting threads in a drilled hole to accept threaded fasteners.

Where Used

- Continuous-duty production drilling
- For initial tap operations and thread chasing
- Wire brushing and deburring
- Screwdriving
- Hole sawing
- General Maintenance

Considerations for Selecting Drills

- What type of material is being drilled?
- What size of hole will need to be drilled?
- What are your horsepower requirements?
- What speed requirements do you have?

Drill Speed Guide

Drill Speed Guide

Material	Surface Ft/Min	Size of Hole to be Drilled							
		1/16 in 1.5 mm	1/8 in 3.0 mm	3/16 in 5.0	1/4 in 6.0 mm	5/16 in 8.0 mm	3/8 in 9.5 mm	7/16 in 11.0 mm	1/2 in 13.0 mm
		Recommended Cutting Speed Range (rpm)							
Steel Alloy, 300-400 Brinell	20-30	1250-1800	600-900	400-600	300-450	250-350	200-300	175-250	150-225
Stainless Steel, Cast Iron, Hard	30-40	1800-2500	900-1200	600-800	450-600	350-500	300-400	250-350	225-300
Steel Forgings	40-50	2500-3100	1200-1500	800-1000	600-750	500-600	400-500	350-425	300-400
Steel, Tool Annealed, .90-1.20 Carbon	50-60	3100-3700	1500-1800	100-1200	750-900	600-700	500-600	425-525	400-450
Steel, .40-.50 Carbon	70-80	4300-5000	2100-2500	1400-1600	1000-1200	850-1000	700-800	600-700	500-600
Cast Iron, Medium Hard	70-100	4300-6000	2100-3000	1400-2000	1000-1500	850-1200	700-1000	600-900	500-800
Bronze, High Tensile Strength	70-150	4300-9000	2100-4500	1400-3000	1000-2300	850-1200	700-1530	600-1300	500-1200
Malleable Iron	80-90	5000-5500	2500-2800	1600-1800	1200-1400	950-1100	800-900	700-800	600-700
Steel, Mild .20-.30 Carbon	80-110	5000-6700	2500-3400	1600-2300	1200-1700	950-1350	800-1150	700-1000	600-850
Cast Iron, Soft Plastic	100-150	6000-9000	3000-4500	2000-3000	1500-2300	1200-1800	1000-1530	900-1300	800-1200
Aluminum, Brass, Bronze	200-300	12,000-18,000	6000-9000	4000-6000	3000-4500	2400-3700	2000-3000	1700-2600	1500-2300
Magnesium	250-400	15,500-25,000	7500-12,000	5000-8200	3800-6100	3000-4900	2500-4000	2200-3500	1900-3000
Fiberglass, Wood	300-400	18,000-25,000	9000-12,000	6000-8200	4600-6100	3700-4900	3000-4000	2600-3500	2300-3000

Actual drilling or cutting RPM will be approximately 70% of rated spindle speed of tool. Surface Feet Per Minute = .26 x RPM x Drill Diameter in Inches.

PISTOL GRIP DRILLS



SDR4P36N2



SDR5P36N2



SDR6P26N3



SDR10P26N3

Performance:

Power: 0.4 hp (0.30 kW) –
1 hp (0.75 kW)

Speed Range: 300 rpm –
23,000 rpm

Chuck Capacity: 1/4" (6 mm) –
1/2" (13 mm)

Features:

Rubber Grip



SDR10P26NK3



SDR10P26NL4



3P1640

Non-Reversible



Model Number	Chuck Capacity		Free Speed rpm	Weight		Length		Side To Center		Air Consumption		Spindle Thread
	in	mm		lb	kg	in	mm	in	mm	scfm	l/s	
0.4 hp (0.30 kW) – Keyed Chuck												
SDR4P5N2	1/4	6	500	1.7	0.8	6.1	155	0.7	17	20	10	3/8"-24
SDR4P5N3	3/8	10	500	1.7	0.8	6.1	155	0.7	17	20	10	3/8"-24
SDR4P8N2	1/4	6	800	1.7	0.8	6.1	155	0.7	17	20	10	3/8"-24
SDR4P12N2	1/4	6	1200	1.7	0.8	6.1	155	0.7	17	20	10	3/8"-24
SDR4P22N2	1/4	6	2200	1.7	0.8	6.1	155	0.7	17	20	10	3/8"-24
SDR4P26N2	1/4	6	2600	1.6	0.7	5.5	140	0.7	17	20	10	3/8"-24
SDR4P26N3	3/8	10	2600	1.6	0.7	5.5	140	0.7	17	20	10	3/8"-24
SDR4P30N2	1/4	6	3000	1.6	0.7	5.5	140	0.7	17	20	10	3/8"-24
SDR4P36N2	1/4	6	3600	1.6	0.7	5.5	140	0.7	17	20	10	3/8"-24
SDR4P43N2	1/4	6	4300	1.6	0.7	5.5	140	0.7	17	20	10	3/8"-24
SDR4P50N2	1/4	6	5000	1.6	0.7	5.5	140	0.7	17	20	10	3/8"-24
SDR4P60N2	1/4	6	6000	1.6	0.7	5.5	140	0.7	17	20	10	3/8"-24
0.4 hp (0.30 kW) – Precision Keyless Chuck												
SDR4P26NK2	1/4	6	2600	2.0	0.9	6.1	155	0.7	17	20	10	3/8"-24
SDR4P30NK2	1/4	6	3000	2.0	0.9	6.1	155	0.7	17	20	10	3/8"-24
0.5 hp (0.37 kW) – Keyed Chuck												
SDR5P5N2	1/4	6	500	1.7	0.8	6.1	155	0.7	17	30	14	3/8"-24
SDR5P7N2	1/4	6	700	1.7	0.8	6.1	155	0.7	17	30	14	3/8"-24
SDR5P8N2	1/4	6	800	1.7	0.8	6.1	155	0.7	17	30	14	3/8"-24
SDR5P12N2	1/4	6	1200	1.7	0.8	6.1	155	0.7	17	30	14	3/8"-24
SDR5P26N2	1/4	6	2600	1.5	0.7	5.5	140	0.7	17	30	14	3/8"-24
SDR5P30N2	1/4	6	3000	1.5	0.7	5.5	140	0.7	17	30	14	3/8"-24
SDR5P36N2	1/4	6	3600	1.5	0.7	5.5	140	0.7	17	30	14	3/8"-24
SDR5P43N2	1/4	6	4300	1.5	0.7	5.5	140	0.7	17	30	14	3/8"-24
SDR5P50N2	1/4	6	5000	1.5	0.7	5.5	140	0.7	17	30	14	3/8"-24
SDR5P230N2	1/4	6	23000	1.3	0.6	4.8	120	0.7	17	30	14	3/8"-24
0.60 hp (0.45 kW) – Keyed Chuck												
SDR6P3N2	1/4	6	300	2.1	0.95	6.8	171	0.8	20	25	12	3/8"-24
SDR6P4N3	3/8	10	400	2.7	1.20	7.3	185	0.8	20	25	12	1/2"-20
SDR6P4N4	1/2	13	400	3.1	1.40	7.8	200	0.8	20	25	12	1/2"-20
SDR6P7N3	3/8	10	700	2.7	1.20	7.3	185	0.8	20	25	12	1/2"-20
SDR6P7N4	1/2	13	700	3.1	1.40	7.8	200	0.8	20	25	12	1/2"-20
SDR6P12N3	3/8	10	1200	2.7	1.20	7.3	185	0.8	20	25	12	1/2"-20
SDR6P26N2	1/4	6	2600	2.1	0.95	5.8	145	0.8	20	25	12	3/8"-24
SDR6P26N3	3/8	10	2600	2.3	1.00	6.3	160	0.8	20	25	12	3/8"-24
SDR6P26N4	1/2	13	2600	2.7	1.20	6.6	170	0.8	20	25	12	1/2"-20
SDR6P40N2	1/4	6	4000	2.1	0.95	5.8	145	0.8	20	25	12	3/8"-24
SDR6P40N3	3/8	10	4000	2.3	1.00	6.3	160	0.8	20	25	12	3/8"-24
SDR6P60N2	1/4	6	6000	2.1	0.95	5.8	145	0.8	20	25	12	3/8"-24
SDR6P60N3	3/8	10	6000	2.3	1.00	6.3	160	0.8	20	25	12	3/8"-24



SAFETY PRECAUTION: Read and follow all safety and operating instructions.

WARNING: Face & eye protection must be worn while operating power tools, per ANSI B186.1

Model Number	Chuck Capacity		Free Speed	Weight		Length		Side To Center		Air Consumption		Spindle Thread
	in	mm	rpm	lb	kg	in	mm	in	mm	scfm	l/s	
0.60 hp (0.45 kW) – Precision Keyless Chuck												
SDR6P7NK3	3/8	10	700	2.7	1.20	7.3	185	0.8	20	25	12	3/8"-24
SDR6P26NK3	3/8	10	2600	2.3	1.00	6.3	160	0.8	20	25	12	3/8"-24
SDR6P40NK3	3/8	10	4000	2.3	1.00	6.3	160	0.8	20	25	12	3/8"-24
SDR6P60NK3	3/8	10	6000	2.3	1.00	6.3	160	0.8	20	25	12	3/8"-24
1 hp (0.75 kW) – Keyed Chuck												
SDR10P4N3	3/8	10	400	2.9	1.30	8.0	205	0.8	20	30	14	1/2"-20
SDR10P4N4	1/2	13	400	3.3	1.50	8.5	215	0.8	20	30	14	1/2"-20
SDR10P7N3	3/8	10	700	2.9	1.30	8.0	205	0.8	20	30	14	1/2"-20
SDR10P7N4	1/2	13	700	3.3	1.50	8.5	215	0.8	20	30	14	1/2"-20
SDR10P12N3	3/8	10	1200	2.9	1.30	8.0	205	0.8	20	30	14	1/2"-20
SDR10P12N4	1/2	13	1200	3.3	1.50	8.5	215	0.8	20	30	1/4	1/2"-20
SDR10P16N3	3/8	10	1600	2.9	1.30	8.0	205	0.8	20	30	14	1/2"-20
SDR10P16N4	1/2	13	1600	3.3	1.50	8.5	215	0.8	20	30	1/4	1/2"-20
SDR10P26N2	1/4	6	2600	2.3	1.05	6.5	165	0.8	20	30	14	3/8"-24
SDR10P26N3	3/8	10	2600	2.5	1.10	7.0	180	0.8	20	30	14	3/8"-24
SDR10P26N4	1/2	13	2600	2.9	1.30	7.5	190	0.8	20	30	14	1/2"-20
SDR10P40N2	1/4	6	4000	2.3	1.05	6.5	165	0.8	20	30	14	3/8"-24
SDR10P40N3	3/8	10	4000	2.5	1.10	7.0	180	0.8	20	30	14	3/8"-24
SDR10P60N2	1/4	6	6000	2.3	1.05	6.5	165	0.8	20	30	14	3/8"-24
SDR10P60N3	3/8	10	6000	2.5	1.10	7.0	180	0.8	20	30	14	3/8"-24
SDR10P180N2	1/4	6	18000	1.85	0.84	5.5	140	0.8	20	30	14	3/8"-24
SDR10P210N2	1/4	6	21000	1.85	0.84	5.5	140	0.8	20	30	14	3/8"-24
1 hp (0.75 kW) – Precision Keyless Chuck												
SDR10P4NK4	1/2	13	400	3.1	1.40	7.8	200	0.8	20	30	14	1/2"-20
SDR10P7NK4	1/2	13	700	3.1	1.40	7.8	200	0.8	20	30	14	1/2"-20
SDR10P12NK3	3/8	10	1200	2.7	1.20	7.3	185	0.8	20	30	14	3/8"-24
SDR10P26NK3	3/8	10	2600	2.3	1.00	6.3	160	0.8	20	30	14	3/8"-24
SDR10P26NK4	1/2	13	2600	2.7	1.20	6.6	170	0.8	20	30	14	1/2"-20
SDR10P40NK3	3/8	10	4000	2.3	1.05	8.3	210	0.8	19	30	14	3/8"-24
SDR10P60NK3	3/8	10	6000	2.5	1.10	7.0	180	0.8	20	30	14	3/8"-24
1 hp (0.75 kW) – Keyless Chuck												
SDR10P26NL4	1/2	13	2600	2.7	1.20	6.7	171	0.8	20	30	14	1/2"-20
1.2 hp (0.90 kW) – Keyed Chuck												
3P1140 ¹	1/2	13	360	5.0	2.30	8.8	224	1.03	26	33	15	1/2"-20
3P1240 ¹	1/2	13	650	5.0	2.30	8.8	224	1.03	26	33	15	1/2"-20
3P1340 ¹	1/2	13	1000	5.0	2.30	8.8	224	1.03	26	33	15	1/2"-20
3P1430 ¹	3/8	10	1400	5.0	2.30	8.8	224	1.03	26	33	15	1/2"-20
3P1530 ¹	3/8	10	2150	4.3	2.00	7.5	190	1.03	26	33	15	1/2"-20
3P1540 ¹	1/2	13	2150	4.3	2.00	7.5	190	1.03	26	33	15	1/2"-20
3P1640 ¹	1/2	13	2650	4.3	2.00	7.5	190	1.03	26	33	15	1/2"-20

¹ Not CE Compliant

General: Air Inlet Size: 1/4" NPT • Recommended Hose Size: 3/8" (10 mm) • Performance rated @ 90 psig (6.2 bar) air pressure

Standard Equipment: Parts List • Safety and Instruction Manual • 3-jaw Chuck and Key • Comfort Grip

Accessories: Drill Accessories, see page 21



SAFETY PRECAUTION: Read and follow all safety and operating instructions.
WARNING: Face & eye protection must be worn while operating power tools, per ANSI B186.1

PISTOL GRIP DRILLS



Performance:

Power: 0.4 hp (0.30 kW) – 1 hp (0.75 kW)
 Speed Range: 300 rpm – 4,000 rpm
 Chuck Capacity: 1/4" (6 mm) – 1/2" (13 mm)

Features:

Rubber Grip

Reversible



Model Number	Chuck Capacity		Free Speed	Weight		Length		Side To Center		Air Consumption		Spindle Thread
	in	mm	rpm	lb	kg	in	mm	in	mm	scfm	l/s	
0.4 hp (0.30 kW) – Keyed Chuck												
SDR4P3R2	1/4	6	300	1.8	0.8	6.4	165	0.7	17	20	10	3/8"-24
SDR4P5R2	1/4	6	500	1.8	0.8	6.4	165	0.7	17	20	10	3/8"-24
SDR4P8R2	1/4	6	800	1.8	0.8	6.4	165	0.7	17	20	10	3/8"-24
SDR4P18R2	1/4	6	1800	1.6	0.7	5.8	150	0.7	16.8	20	10	3/8"-24
SDR4P20R2	1/4	6	2000	1.6	0.7	5.8	150	0.7	16.8	20	10	3/8"-24
SDR4P24R2	1/4	6	2400	1.6	0.7	5.8	150	0.7	16.8	20	10	3/8"-24
SDR4P30R2	1/4	6	3000	1.6	0.7	5.8	150	0.7	16.8	20	10	3/8"-24
SDR4P33R2	1/4	6	3300	1.6	0.7	5.8	150	0.7	16.8	20	10	3/8"-24
0.5 hp (0.37 kW) – Keyed Chuck												
SDR5P3R2	1/4	6	300	1.7	0.8	6.4	165	0.7	16.8	30	14	3/8"-24
SDR5P5R2	1/4	6	500	1.7	0.8	6.4	165	0.7	16.8	30	14	3/8"-24
SDR5P8R2	1/4	6	800	1.7	0.8	6.4	165	0.7	16.8	30	14	3/8"-24
SDR5P18R2	1/4	6	1800	1.5	0.7	5.8	150	0.7	16.8	30	14	3/8"-24
SDR5P20R2	1/4	6	2000	1.5	0.7	5.8	150	0.7	16.8	30	14	3/8"-24
SDR5P24R2	1/4	6	2400	1.5	0.7	5.8	150	0.7	16.8	30	14	3/8"-24
SDR5P30R2	1/4	6	3000	1.5	0.7	5.8	150	0.7	16.8	30	14	3/8"-24
SDR5P33R2	1/4	6	3300	1.5	0.7	5.8	150	0.7	16.8	30	14	3/8"-24
0.60 hp (0.45 kW) – Keyed Chuck												
SDR6P20R3	3/8	10	2000	2.3	1.00	6.3	160	0.8	17	25	12	3/8"-24
0.60 hp (0.45 kW) – Keyless Chuck												
SDR6P20RK3	3/8	10	2000	2.6	1.15	6.8	175	0.8	17	25	12	3/8"-24
1 hp (0.75 kW) – Keyed Chuck												
SDR10P3R3	3/8	10	300	3.1	1.40	8.6	220	0.8	20	30	14	1/2"-20
SDR10P3R4	1/2	13	300	3.6	1.60	9.1	230	0.8	20	30	14	1/2"-20
SDR10P5R3	3/8	10	500	3.1	1.40	8.6	220	0.8	20	30	14	1/2"-20
SDR10P5R4	1/2	13	500	3.6	1.60	9.1	230	0.8	20	30	14	1/2"-20
SDR10P7R3	3/8	10	700	3.1	1.40	8.6	220	0.8	20	30	14	1/2"-20
SDR10P7R4	1/2	13	700	3.6	1.60	9.1	230	0.8	20	30	14	1/2"-20
SDR10P12R3	3/8	10	1200	3.1	1.40	8.6	220	0.8	20	30	14	1/2"-20
SDR10P12R4	1/2	13	1200	3.6	1.60	9.1	230	0.8	20	30	14	1/2"-20
SDR10P20R2	1/4	6	2000	2.4	1.10	7.1	180	0.8	20	30	14	3/8"-24
SDR10P20R3	3/8	10	2000	2.6	1.15	7.6	195	0.8	20	30	14	3/8"-24
SDR10P20R4	1/2	13	2000	3.0	1.35	7.9	200	0.8	20	30	14	1/2"-20
SDR10P25R3	3/8	10	2500	2.6	1.15	7.6	195	0.8	20	30	14	3/8"-24
SDR10P40R2	1/4	6	4000	2.4	1.10	7.1	180	0.8	20	30	14	3/8"-24
SDR10P40R3	3/8	10	4000	2.6	1.15	7.6	195	0.8	20	30	14	3/8"-24
1 hp (0.75 kW) – Keyless Chuck												
SDR10P3RK4	1/2	13	300	3.6	1.60	9.1	230	0.8	20	30	14	1/2"-20
SDR10P5RK4	1/2	13	500	3.6	1.60	9.1	230	0.8	20	30	14	1/2"-20
SDR10P7RK4	1/2	13	700	3.6	1.60	9.1	241	0.8	20	30	14	1/2"-20
SDR10P12RK4	1/2	13	1200	3.6	1.60	9.1	230	0.8	20	30	14	1/2"-20
SDR10P20RK3	3/8	10	2000	2.6	1.20	7.6	195	0.8	20	30	14	3/8"-24
SDR10P20RK4	1/2	13	2000	3.0	1.35	8.0	205	0.8	20	30	14	1/2"-20
SDR10P25RK3	3/8	10	2500	2.6	1.15	7.6	195	0.8	20	30	14	3/8"-24
SDR10P40RK3	3/8	10	4000	2.6	1.15	7.6	195	0.8	20	30	14	3/8"-24



SDR4P3R2



SDR5P24R2



SDR6P20R3



SDR10P25R3



SDR10P20RK3

General: Air Inlet Size: 1/4" NPT • Recommended Hose Size: 3/8" (10 mm) • Performance rated @ 90 psig (6.2 bar) air pressure

Standard Equipment: Parts List • Safety and Instruction Manual • 3-jaw Chuck and Key • Comfort Grip

Accessories: Drill Accessories, see page 21



SAFETY PRECAUTION: Read and follow all safety and operating instructions.
WARNING: Face & eye protection must be worn while operating power tools, per ANSI B186.1

RAPID REVERSE DRILLS



SDR4P20R2RR



SDR10P20R3RR



SDR6P20R3RR



SDR10P20RK3R



Performance:

Power: 0.4 hp (0.30 kW) – 1 hp (0.75 kW)
 Speed Range: 500 rpm – 2,500 rpm
 Chuck Capacity: 1/4" (6 mm) – 1/2" (13 mm)

Features:

Rubber Grip

Rapid Reverse

Model Number	Chuck Capacity		Free Speed rpm	Weight		Length		Side To Center		Air Consumption		Spindle Thread
	in	mm		lb	kg	in	mm	in	mm	scfm	l/s	
0.4 hp (0.30 kW) – Keyed Chuck												
SDR4P20R2RR	1/4	6	2000	1.7	0.7	6.0	150	0.7	16.8	20	10	3/8"-24
SDR4P30R2RR	1/4	6	3000	1.7	0.7	6.0	150	0.7	16.8	20	10	3/8"-24
0.60 hp (0.45 kW) – Keyed Chuck												
SDR6P20R3RR	3/8	10	2000	2.4	1.25	6.9	175	0.8	20	25	12	3/8"-24
SDR6P25R3RR	3/8	10	2500	2.4	1.25	6.9	175	0.8	20	25	12	3/8"-24
0.60 hp (0.45 kW) – Keyless Chuck												
SDR6P7RK4RR	1/2	13	700	3.0	1.36	8.4	215	0.8	20	25	12	1/2"-20
SDR6P20RK3RR	3/8	10	2000	2.4	1.25	6.9	175	0.8	20	25	12	3/8"-24
SDR6P20RK4RR	1/2	13	2000	2.7	1.20	7.3	185	0.8	20	25	12	1/2"-20
SDR6P25RK3RR	3/8	10	2500	2.4	1.25	6.9	175	0.8	20	25	12	3/8"-24
SDR6P25RK4RR	1/2	13	2500	2.7	1.20	7.3	185	0.8	20	25	12	1/2"-20
1 hp (0.75 kW) – Keyed Chuck												
SDR10P5R4RR	1/2	13	500	3.6	1.63	8.8	224	0.8	20	30	14	1/2"-20
SDR10P20R3RR	3/8	10	2000	2.6	1.15	7.6	195	0.8	20	30	14	3/8"-24
SDR10P25R3RR	3/8	10	2500	2.6	1.15	7.6	195	0.8	20	30	14	3/8"-24
SDR10P25R4RR	1/2	13	2500	3.0	1.36	7.9	200	0.8	20	30	14	1/2"-20
1 hp (0.75 kW) – Keyless Chuck												
SDR10P7RK4R	1/2	13	700	3.1	1.40	9.5	241	0.8	20	30	14	1/2"-20
SDR10P20RK3R	3/8	10	2000	2.6	1.15	7.6	195	0.8	20	30	14	3/8"-24
SDR10P20RK4R	1/2	13	2000	2.8	1.27	7.6	195	0.8	20	30	14	1/2"-20
SDR10P25RK3R	3/8	10	2500	2.6	1.15	7.6	195	0.8	20	30	14	3/8"-24
SDR10P25RK4R	1/2	13	2500	2.8	1.27	7.6	195	0.8	20	30	14	1/2"-20

General: Air Inlet Size: 1/4" NPT • Recommended Hose Size: 3/8" (10 mm) • Performance rated @ 90 psig (6.2 bar) air pressure

Standard Equipment: Parts List • Safety and Instruction Manual • 3-jaw Chuck and Key • Comfort Grip

Accessories: Drill Accessories, see page 21



SAFETY PRECAUTION: Read and follow all safety and operating instructions.
WARNING: Face & eye protection must be worn while operating power tools, per ANSI B186.1

STRAIGHT DRILLS



Performance:

Power: 0.4 hp (0.30 kW) – 1 hp (0.75 kW)
 Speed Range: 300 rpm – 21,000 rpm
 Chuck Capacity: 1/4" (6 mm) – 1/2" (13 mm)

Features:

Reversible and Non-Reversible
 Lever Start
 Comfort Grip



SDR4S36N2L



SDR10S25R3



SDR10S26N3

Straight Drills



Model Number	Chuck Capacity		Free Speed rpm	Weight		Length		Side To Center		Air Consumption		Spindle Thread
	in	mm		lb	kg	in	mm	in	mm	scfm	l/s	
0.4 hp (0.30 kW) – Non-Reversible												
SDR4S30N2L	1/4	6	3000	1.8	0.8	7.4	190	0.7	20	21	10	3/8"-24
SDR4S36N2L	1/4	6	3600	1.8	0.8	7.4	190	0.7	20	21	10	3/8"-24
SDR4S60N2L	1/4	6	6000	1.8	0.8	7.4	190	0.7	20	21	10	3/8"-24
1 hp (0.75 kW) – Non-reversible												
SDR10S4N3	3/8	10	400	2.8	1.25	9.3	236	0.8	20	30	14	1/2"-20
SDR10S4N4	1/2	13	400	2.8	1.25	9.3	236	0.8	20	30	14	1/2"-20
SDR10S7N3	3/8	10	700	2.8	1.25	9.3	236	0.8	20	30	14	1/2"-20
SDR10S12N3	3/8	10	1200	2.8	1.25	9.3	236	0.8	20	30	14	1/2"-20
SDR10S16N3	3/8	10	1600	2.8	1.25	9.3	236	0.8	20	30	14	1/2"-20
SDR10S26N2	1/4	6	2600	2.3	1.05	8.3	211	0.8	20	30	14	3/8"-24
SDR10S26N3	3/8	10	2600	2.3	1.05	8.3	211	0.8	20	30	14	3/8"-24
SDR10S40N2	1/4	6	4000	2.3	1.05	8.3	211	0.8	20	30	14	3/8"-24
SDR10S40N3	3/8	10	4000	2.3	1.05	8.3	211	0.8	20	30	14	3/8"-24
SDR10S60N2	1/4	6	6000	2.3	1.05	8.3	211	0.8	20	30	14	3/8"-24
SDR10S60N3	3/8	10	6000	2.3	1.05	8.3	211	0.8	20	30	14	3/8"-24
SDR10S180N2	1/4	6	18000	1.85	0.84	7.3	185	0.8	20	30	14	3/8"-24
SDR10S210N2	1/4	6	21000	1.85	0.84	7.3	185	0.8	20	30	14	3/8"-24
1 hp (0.75 kW) – Reversible												
SDR10S3R3	3/8	10	300	2.8	1.25	10.8	273	0.8	20	30	14	1/2"-20
SDR10S3R4	1/2	13	300	3.2	1.45	11.3	285	0.8	20	30	14	1/2"-20
SDR10S5R3	3/8	10	500	2.8	1.25	10.8	273	0.8	20	30	14	1/2"-20
SDR10S5R4	1/2	13	500	3.2	1.45	11.3	285	0.8	20	30	14	1/2"-20
SDR10S7R3	3/8	10	700	2.8	1.25	10.8	273	0.8	20	30	14	1/2"-20
SDR10S7R4	1/2	13	700	3.2	1.45	11.3	285	0.8	20	30	14	1/2"-20
SDR10S12R3	3/8	10	1200	2.8	1.25	10.8	273	0.8	20	30	14	1/2"-20
SDR10S12R4	1/2	13	1200	3.2	1.45	11.3	285	0.8	20	30	14	1/2"-20
SDR10S20R2	1/4	6	2000	2.2	1.00	9.3	235	0.8	20	30	14	3/8"-24
SDR10S20R3	3/8	10	2000	2.3	1.05	9.8	248	0.8	20	30	14	3/8"-24
SDR10S20R4	1/2	10	2000	2.8	1.25	10.3	260	0.8	20	30	14	1/2"-20
SDR10S25R2	1/4	6	2500	2.2	1.00	9.3	235	0.8	20	30	14	3/8"-24
SDR10S25R3	3/8	10	2500	2.3	1.05	9.8	248	0.8	20	30	14	3/8"-24
SDR10S40R2	1/4	6	4000	2.2	1.00	9.3	235	0.8	20	30	14	3/8"-24
SDR10S40R3	3/8	10	4000	2.3	1.05	9.8	243	0.8	20	30	14	3/8"-24

General: Air Inlet Size: 1/4" NPT • Recommended Hose Size: 3/8" • Performance rated @ 90 psig (6.2 bar) air pressure

Standard Equipment: Parts List • Safety and Instruction Manual • Suspension Bail (SDR10S) • 3-jaw Chuck and Key

Accessories: Drill Accessories, see page 21



SAFETY PRECAUTION: Read and follow all safety and operating instructions.

WARNING: Face & eye protection must be worn while operating power tools, per ANSI B186.1

MINIATURE ANGLE DRILLS



Performance:

Power: 0.4 hp (0.30 kW)
Speed Range: 800 rpm – 5,700 rpm

Features:

Non-Reversible
Safety Lever

Miniature Angle Drills

Model Number	Free Speed		Weight		Length		Side to Center		Air Consumption		Spindle Internal Thread
	rpm		lb	kg	in	mm	in	mm	scfm	l/s	
90° Standard Angle Head – 0.4 hp (0.30 kW)											
SDR4A8S8L	800		2.1	0.94	10.0	255	0.7	20	21	10	1/4"-28
SDR4A20S8L	2000		1.9	0.87	9.5	240	0.7	20	21	10	1/4"-28
SDR4A27S8L	2700		1.9	0.87	9.5	240	0.7	20	21	10	1/4"-28
SDR4A33S8L	3300		1.9	0.87	9.5	240	0.7	20	21	10	1/4"-28
SDR4A44S8L	4400		1.9	0.87	9.5	240	0.7	20	21	10	1/4"-28
SDR4A55S8L	5500		1.9	0.87	9.5	240	0.7	20	21	10	1/4"-28
SDR4A27S9L	2700		1.9	0.87	9.5	240	0.7	20	21	10	9/32"-40
90° Compact Angle Head – 0.4 hp (0.30 kW)											
SDR4A28C8L	2800		1.9	0.84	9.5	240	0.7	20	21	10	1/4"-28
SDR4A35C8L	3500		1.9	0.84	9.5	240	0.7	20	21	10	1/4"-28
SDR4A47C8L	4700		1.9	0.84	9.5	240	0.7	20	21	10	1/4"-28
SDR4A57C8L	5700		1.9	0.84	9.5	240	0.7	20	21	10	1/4"-28
90° Heavy Duty Angle Head – 0.4 hp (0.30 kW)											
SDR4A8H8L	800		2.2	0.99	10.3	260	0.7	20	21	10	1/4"-28
SDR4A13H8L	1300		2.2	0.99	10.3	260	0.7	20	21	10	1/4"-28
SDR4A21H8L	2100		2.0	0.92	9.8	250	0.7	20	21	10	1/4"-28
SDR4A28H8L	2800		2.0	0.92	9.8	250	0.7	20	21	10	1/4"-28
SDR4A35H8L	3500		2.0	0.92	9.8	250	0.7	20	21	10	1/4"-28
45° Angle Head – 0.4 hp (0.30 kW)											
SDR4A8F8L	800		2.0	0.92	10.3	260	0.7	20	21	10	1/4"-28
SDR4A21F8L	2100		1.9	0.85	9.8	250	0.7	20	21	10	1/4"-28
SDR4A28F8L	2800		1.9	0.85	9.8	250	0.7	20	21	10	1/4"-28
SDR4A35F8L	3500		1.9	0.85	9.8	250	0.7	20	21	10	1/4"-28
SDR4A47F8L	4700		1.9	0.85	9.8	250	0.7	20	21	10	1/4"-28
SDR4A57F8L	5700		1.9	0.85	9.8	250	0.7	20	21	10	1/4"-28
SDR4A28F9L	2800		1.9	0.85	9.8	250	0.7	20	21	10	9/32"-40
360° Swivel Head – 0.4 hp (0.30 kW)											
SDR4A18T8L	1800		2.1	0.97	10.0	265	0.7	20	21	10	1/4"-28
SDR4A29T8L	2900		2.1	0.97	10.0	265	0.7	20	21	10	1/4"-28
SDR4A48T8L	4800		2.1	0.97	10.0	265	0.7	20	21	10	1/4"-28
Sealant Removal Kit with 90° & 45° Head – 0.4 hp (0.30 kW)											
SDR4A8SF-SRK	800		2.1	0.94	10.0	255	0.7	20	21	10	1/4"-28
Sealant Removal Kit with 45° Head – 0.4 hp (0.30 kW)											
SDR4A8F-SRK	800		2.0	0.92	10.0	260	0.7	20	21	10	1/4"-28
Sealant Removal Kit with 90° Head – 0.4 hp (0.30 kW)											
SDR4A8S-SRK	800		2.1	0.94	10.0	255	0.7	20	21	10	1/4"-28

General: Air Inlet Size: 1/4" NPT • Recommended Hose Size: 3/8" (10 mm) • Performance rated @ 90 psig (6.2 bar) air pressure

Standard Equipment: Parts List • Safety and Instruction Manual

Accessories: Drill Accessories, see page 21



SAFETY PRECAUTION: Read and follow all safety and operating instructions.
WARNING: Face & eye protection must be worn while operating power tools, per ANSI B186.1

MINIATURE ANGLE DRILLS



Head Dimensions (in.)

Head Type	Accessory SKU	A	B	C
Standard 90°	SP75990	3.04	1.11	0.71
Compact 90°	SP76006	3.02	0.88	0.67
Heavy Duty 90°	SP76002	3.31	1.08	0.97
45°	SP75994	3.34	1.11	0.72
360°	SP76008	3.44	3.14	0.71

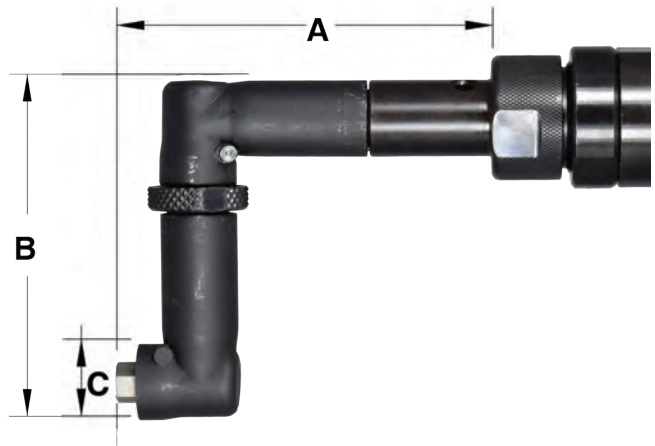
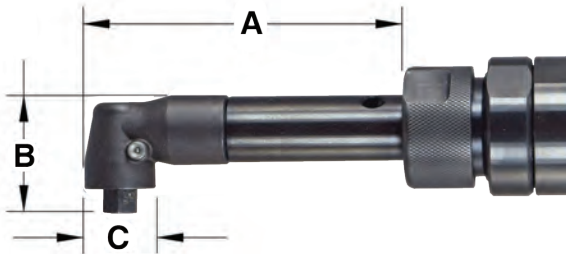
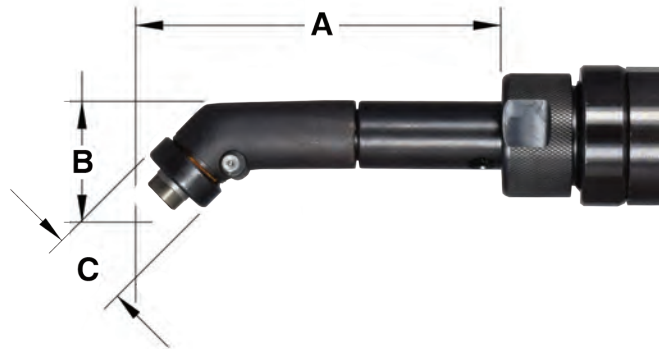
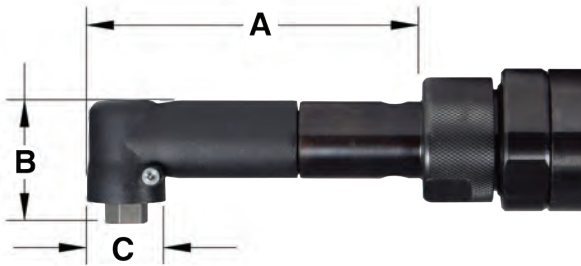
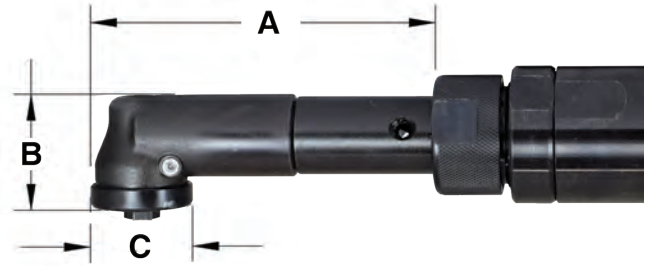

LARGE ANGLE DRILLS

Performance:

Power: 1 hp (0.75 kW) – 1.2 hp (0.9 kW)
 Speed Range: 300 rpm – 3,000 rpm
 Chuck Capacity: 1/4" (6 mm) – 1/2" (13 mm)

Features:

Reversible and Non-Reversible
 Lever Start
 Heads can be rotated 360°
 Rear or Side Exhaust

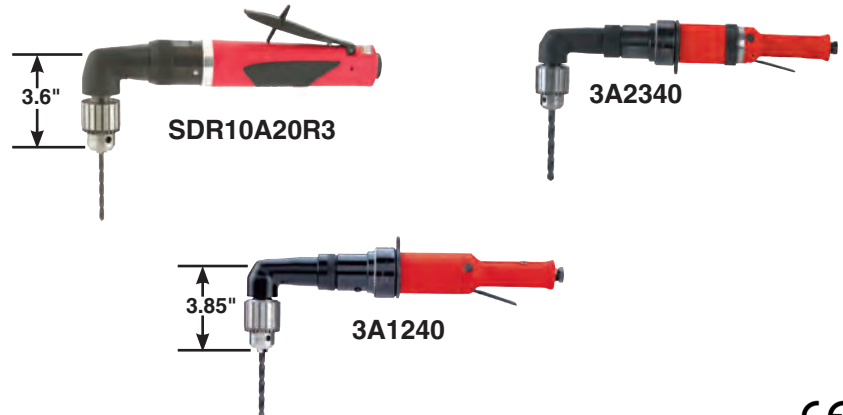

Right Angle Drills

Model Number	Chuck Capacity		Free Speed rpm	Weight		Length		Side To Center		Air Consumption		Spindle Thread
	in	mm		lb	kg	in	mm	in	mm	scfm	l/s	
1 hp (0.75 kW) – Non-Reversible												
SDR10A4N3	3/8	10	400	3.3	1.50	11.2	285	0.8	19	30	14	3/8"-24
SDR10A4N4	1/2	13	400	3.7	1.65	11.2	285	0.8	19	30	14	3/8"-24
SDR10A10N3	3/8	10	1000	3.3	1.50	11.2	285	0.8	19	30	14	3/8"-24
SDR10A10N4	1/2	13	1000	3.7	1.65	11.2	285	0.8	19	30	14	3/8"-24
SDR10A13N2	1/4	6	1300	3.2	1.40	11.2	285	0.8	19	30	14	3/8"-24
SDR10A13N3	3/8	10	1300	3.3	1.50	11.2	285	0.8	19	30	14	3/8"-24
SDR10A22N2	1/4	6	2200	2.9	1.30	10.2	260	0.8	19	30	14	3/8"-24
SDR10A22N3	3/8	10	2200	3.0	1.35	10.2	260	0.8	19	30	14	3/8"-24
SDR10A30N2	1/4	6	3000	2.9	1.30	10.2	260	0.8	19	30	14	3/8"-24
1 hp (0.75 kW) – Reversible												
SDR10A3R3	3/8	10	300	3.3	1.50	12.0	305	0.8	19	30	14	3/8"-24
SDR10A3R4	1/2	13	300	3.7	1.65	12.0	305	0.8	19	30	14	3/8"-24
SDR10A6R3	3/8	10	600	3.3	1.50	12.0	305	0.8	19	30	14	3/8"-24
SDR10A6R4	1/2	13	600	3.7	1.65	12.0	305	0.8	19	30	14	3/8"-24
SDR10A10R3	3/8	10	1000	3.3	1.50	12.0	305	0.8	19	30	14	3/8"-24
SDR10A10R4	1/2	13	1000	3.7	1.65	12.0	305	0.8	19	30	14	3/8"-24
SDR10A16R2	1/4	6	1600	3.2	1.40	12.0	305	0.8	19	30	14	3/8"-24
SDR10A16R3	3/8	10	1600	3.3	1.50	12.0	305	0.8	19	30	14	3/8"-24
SDR10A20R2	1/4	6	2000	2.9	1.30	11.0	280	0.8	19	30	14	3/8"-24
SDR10A20R3	3/8	10	2000	3.0	1.35	11.0	280	0.8	19	30	14	3/8"-24
1.2 hp (0.9 kW) – 3-Series Non-reversible – Side Exhaust¹												
3A1140 ¹	1/2	13	360	6.5	2.90	15.1	384	0.8	19	33	16	1/2"-20
3A1240 ¹	1/2	13	600	6.5	2.90	15.1	384	0.8	19	33	16	1/2"-20
3A1530 ¹	3/8	10	1800	6.5	2.90	15.1	384	0.8	19	33	16	1/2"-20
1.2 hp (0.9 kW) – 3-Series Reversible – Side Exhaust¹												
3A2140 ¹	1/2	13	300	6.9	3.10	15.5	394	0.8	19	33	16	1/2"-20
3A2240 ¹	1/2	13	480	6.9	3.10	15.5	394	0.8	19	33	16	1/2"-20
3A2340 ¹	1/2	13	700	6.9	3.10	15.5	394	0.8	19	33	16	1/2"-20
3A2430 ¹	3/8	10	1000	6.3	2.90	15.4	391	0.8	19	33	16	1/2"-20

¹ Not CE Certified

General: Air Inlet Size: 1/4" NPT • Recommended Hose Size: 3/8" (10 mm) • Performance rated @ 90 psig (6.2 bar) air pressure

Standard Equipment: Parts List • Safety and Instruction Manual • 3-jaw Chuck and Key

Accessories: Drill Accessories, see page 21



SAFETY PRECAUTION: Read and follow all safety and operating instructions.
WARNING: Face & eye protection must be worn while operating power tools, per ANSI B186.1

D-HANDLE DRILLS



Performance:

Power: 1.2 hp (0.9 kW)
 Speed Range: 375 rpm – 2,000 rpm
 Chuck Capacity: 3/8" (10 mm) – 1/2" (13 mm)

Features:

Side Exhaust
 Support Handle Included
 Swivel Air Inlet

1465

D-Handle Drills

Model Number	Chuck Capacity		Free Speed rpm	Weight		Length		Side To Center		Air Consumption		Spindle Thread
	in	mm		lb	kg	in	mm	in	mm	scfm	l/s	
"D" Handle Drill – 1.2 hp (0.9 kW) – Non-Reversible												
DR1467	1/2	13	375	6.6	3	13.4	340	1	25	30	14	1/2"-20
1466	1/2	13	550	6.6	3	13.4	340	1	25	30	14	1/2"-20
1465	3/8	10	1000	6.4	2.9	13.3	338	1	25	30	14	1/2"-20
1465-1/2	1/2	13	1000	6.6	3	13.4	340	1	25	30	14	1/2"-20
1464	1/2	13	2000	6.6	3	13.4	340	1	25	30	14	1/2"-20

General: Air Inlet Size: 1/4" NPT • Recommended Hose Size: 3/8" (10 mm) • Performance rated @ 90 psig (6.2 bar) air pressure

Standard Equipment: Parts List • Safety and Instruction Manual • 3-jaw Chuck and Key • Swivel Air Inlet

Accessories: Drill Accessories, see page 21

T-HANDLE DRILLS



SDR10T26N4

Performance:

Power: 1 hp (0.75 kW) – 1.2 hp (0.9 kW)
 Speed Range: 360 rpm – 4,000 rpm
 Chuck Capacity: 3/8" (10 mm) – 1/2" (13 mm)

Features:

Lever Start
 Handle Grips

T-Handle Drills

Model Number	Chuck Capacity		Free Speed rpm	Weight		Length		Air Consumption		Spindle Thread
	in	mm		lb	kg	in	mm	scfm	l/s	
Signature Series – 1 hp (0.75 kW) – Non-reversible										
SDR10T4N4	1/2	13	400	6.3	2.9	36	914	35	17	1/2"-20
SDR10T7N4	1/2	13	700	6.3	2.9	36	914	35	17	1/2"-20
SDR10T12N4	1/2	13	1200	6.3	2.9	36	914	35	17	1/2"-20
SDR10T16N4	1/2	13	1600	6.3	2.9	36	914	35	17	1/2"-20
SDR10T26N3	3/8	10	2600	5.6	2.5	36	914	35	17	3/8"-24
SDR10T26N4	1/2	13	2600	5.9	2.7	36	914	35	17	1/2"-20
SDR10T40N3	3/8	10	4000	5.6	2.5	36	914	35	17	3/8"-20
3 - Series – 1.2 hp (0.9 kW) – Non-reversible										
3T1140	1/2	13	360	7.6	3.5	35	889	35	17	1/2"-20
3T1340	1/2	13	1000	7.6	3.5	35	889	35	17	1/2"-20
3T1530	3/8	10	2150	7.3	3.3	35	889	35	17	1/2"-20
3T1630	3/8	10	2650	7.3	3.3	35	889	35	17	1/2"-20
3T1640	1/2	13	2650	7.4	3.4	35	889	35	17	1/2"-20

General: Air Inlet Size: 1/4" NPT • Recommended Hose Size: 3/8" (10 mm) • Performance rated @ 90 psig (6.2 bar) air pressure

Standard Equipment: Parts List • Safety and Instruction Manual • 3-jaw Chuck and Key • Comfort Grip

Accessories: Drill Accessories, see page 21



3T1630



SAFETY PRECAUTION: Read and follow all safety and operating instructions.

WARNING: Face & eye protection must be worn while operating power tools, per ANSI B186.1

Drill Chucks & Keys



SP21019T



SP21019B



SP21133



SP21132



SP21002



SP21131



SP21137



SP67398



SP67397



74375



69005



69006

Chuck Capacity	Thread Size	Chuck Part No	Key Part No	Key Holder No
0 – 1/4"	3/8"-24	SP21019T	30202	
0 – 1/4"	3/8"-24	SP21019B	30000	
1/16" – 3/8"	3/8"-24	SP21133	30002	14273
5/64" – 1/2"	3/8"-24	SP21132	30429	
0 – 3/8"	1/2"-20	SP21002	30011	14273
1/16" – 3/8"	1/2"-20	SP21131	30002	
5/64" – 1/2"	1/2"-20	SP21137	30011	14273
0" – 1/2"	1/2"-20	SP74222	30429	
1/32" – 3/8" ¹	3/8"-24	SP67398		
1/16" – 1/2" ¹	1/2"-20	SP67397		
0 – 1/4" ²	3/8"-24	74375		
0 – 3/8" ²	3/8"-24	69005		
0 – 1/2" ²	1/2"-20	69006		

¹Keyless Chuck • Keyed chucks include key

²Precision Keyless Chuck

Quick Change Chuck

Part No 2352

Adapts 3/8"-24 threaded spindles to 1/4" hex quick change



Non-Reversing Only

Sealant Removal Cutters



SR40



SR83

Sioux Part Number	Description
SR40	#3 (0.40") SR Cutter
SR83	#8 (0.83") SR Cutter

Sold in case of 40

Support Handles



2355B



77067A

Sioux Part Number	Description
2355B	For use on 3P series drills
77117A	For use on 4P, 5P series drills
77067A	6P, 10P series drills

Comfort Grips

For use on SDR4P pistol grip drills



68340

For use on Signature series non-reversing drills



SDR6PNBOOT / SDR10PNBOOT



SAFETY PRECAUTION: Read and follow all safety and operating instructions.
WARNING: Face & eye protection must be worn while operating power tools, per ANSI B186.1

ASSEMBLY



Index

Screwdrivers 27 – 33
Nutrunners 34
Ratchet Wrenches 35

Impact Drivers 37
Impact Wrenches 38 – 40
Assembly Accessories 41

ASSEMBLY

Combining Efficiency, Reliability and Value...

Putting it all together

To keep up with the rapidly growing demands of modern assembly applications, Sioux Tools remains on the cutting edge of engineering design. We continue to be innovative in creating new tools to provide faster rundown speeds with exceptional accuracy and consistent torque delivery, combined with ergonomic design for operator comfort and safety.

We build every tool to help assembly operators become more productive. We believe they deserve tools that will help improve their quality of performance and maximize the skills they bring to the job.

Exclusive Designs

Sioux Tools is the exclusive manufacturer of the Z-handle. This unique feature allows access to tight, hard to reach angles.

Impact Wrenches

Suitable for general assembly, repair jobs etc. When you require a powerful, lightweight tool, with little reaction force and moderate accuracy. This is the best choice for loosening joints.

Screwdrivers

Sioux Tools offers a wide range of screwdrivers designed to meet today's fast paced, high output assembly and manufacturing applications.

Nutrunners

Sioux offers nutrunners that are designed for high volume industrial production. You can choose from free speeds of up to 2200 rpm, and a torque range of up to 600 in lb (68 Nm). These are outstanding tools for fast accurate assembly.

Assembly Safety

Broken sockets, bits and adapters can cause injury.

Proper eye protection must be worn at all times by tool user and bystanders. Use only sockets, bits and adapters made for power tools and that are in good condition. Use only bits and adapters that are in good condition. Keep hands away from sockets, bits and adapters.

Sudden and unexpected tool movement can cause injury.

Be sure your body position allows you to have control of the tool at all times. Make sure your footing is secure. Consult manufacturer for proper reaction bar if movement is excessive.

Tools starting unexpectedly can cause injury.

Always remove the tool from air supply and activate trigger to bleed air line before making any adjustments, changing accessories, or doing any maintenance or service on the tool.

Falling tools can cause injury.

If the tool is used with a balancer or other suspension device, be sure the tool is firmly attached to the device.

Assembly Principles of Operation

An air motor and planetary reduction gearing are used to drive a clutch spindle, producing torque in a fastener.

The action of the torque creates clamp-load in the assembly.

Motor size (horsepower), gear ratio, and type of clutch determine performance, and are key factors in selecting the appropriate tool for a given application.

Generally equipped with a 1/4" female hexagon spindle that allows inserting a screwdriver bit.

An Easy Drive Home



Sioux Tools offers a wide range of screwdrivers and nutrunners designed to meet today's fast paced, high output assembly and manufacturing applications. Sioux Tools is able to provide a perfect match for any job requirement. As industries strive to reduce fastener requirements, we work to meet the demand for greater accuracy and precision in fastening performance. The productivity demands for quality and speed, as well as user comfort, convenience and safety make Sioux Tools your number one choice.

Configurations

Sioux screwdrivers are available in pistol grip, inline, right angle and our exclusive Z-handle configurations. Most screwdriver models offer your choice of Quick Change or Locking Internal Hex spindles. The spring-loaded chuck on the Quick Change



allows for fast, easy bit changes without the need for additional tools or hardware. The slimmer design of the Locking Internal Hex ensures that the bit stays firmly in place until you choose to remove it with the aid of a vise or pliers.

Reducing Physical Load

We design all our screwdrivers with ergonomics in mind. We help you get the job done with a minimum amount of effort and wear and tear on the operator. By reducing the physical load on the operator, which includes noise and oil mist, productivity will be improved. Sioux Tools offers many benefits including high torque accuracy, low sound levels and ergonomic grips. Fast clutch shutoff reduces reaction force, while the shape reduces the amount of gripping and trigger force required.

Clutch Selection

Positive Clutch – Spindle will not turn with motor until operator exerts forward pressure on spindle engaging the clutch. The clutch ratchets when torque resistance from the fastener overcomes the forward pressure and the jaws begin to cam apart. Torque output of the tool is determined by forward pressure from operator and by the cam angle of the clutch jaws. For wood, sheet metal, and machine screws and lag bolts.

Sioux Tools is the exclusive manufacturer of three different positive clutches; Low, Mid and High torque output. Your choice of clutch allows you to more precisely control the amount of torque exerted on the fastener.

Stall Drive – Spindle is coupled directly with the output of the motor. Final torque is reached when resistance of the fastener overcomes the torque output of the motor. Final torque can be influenced by air pressure and/or operator twisting the tool.





For prevailing torque or soft pull applications involving machine, wood, or self-tapping screws.

Adjustable Clutch – Spindle will not turn with motor until operator exerts forward pressure on spindle engaging the clutch. When fastener is tight, clutch will ratchet. Adjusting spring pressure will effect final output torque. Offers consistent torque control with little operator reaction.

Torque Control – Motor shuts off automatically when fastener is tight. Adjusting spring pressure changes final output torque for critical torque requirements. Perfect for applications with little or no prevailing torque where final torque is substantially higher than rundown torque.

Direct Clutch – Spindle will not turn with motor until operator exerts forward pressure on spindle engaging the clutch. Final torque is reached when resistance of the fastener overcomes the torque output of the motor. Excellent stall type tool when tightening group of fasteners without turning off motor.

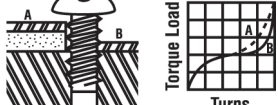
Clutch Selection Guide

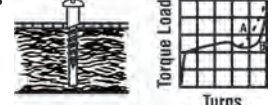
Type of Job	Clutch Performance			
	Torque Control	Adjustable	Direct/Stall Drive	Positive Clutch
<p>1. Free-Running – Sudden Stop</p>  <p>Turns easily until screw head or nut seats against a solid stop. Resistance then builds up suddenly.</p>	Excellent for all size screws.	Good for all size screws. Close torque control is not required.	Good for large or medium nuts or cap screws only.	Fair for all size screws where close torque accuracy is not required.
<p>2. Soft Pull-Up</p>  <p>Turns easily until screw head or nut seats, then resistance builds up gradually through one or more turns as resilient material compressed.</p>	Excellent for all size screws.	Good for most screws. Close torque control is not required. Slow on large screws with long pull-up.	Good for large and medium size screws. Must be adjusted to run rather slowly for small screws.	Good for small to medium size screws. Requires considerable operator pressure on large screws.
<p>3. Self-Tapping in Thick Material</p>  <p>Increasing heavy resistance through entire travel until screw head seats. Then either (A) gradual, or (B) sudden final build-up resistance.</p>	Excellent for all size screws. Not suitable if tapping torque exceeds stripping torque.	Good for most screws. With proper operator technique, can be used where tapping torque exceeds stripping torque. Slow on large screws.	Not recommended unless stripping torque is considerably higher than tapping torque.	Good for most size screws where stripping torque is considerably higher than tapping torque. Excellent in non-uniform or misaligned material.
<p>4. Sheet Metal Screws</p>  <p>Resistance increases rapidly at first, then eases slightly. At the end, it usually builds up suddenly when screw head seats.</p>	Good for all size screws. Not suitable if tapping torque exceeds stripping torque.	Good for most screws. With proper operator technique, can be used where tapping torque exceeds stripping torque.	Not recommended unless stripping torque is considerably higher than tapping torque.	Good for all size screws where stripping torque is considerably higher than tapping torque. Excellent when sheets are frequently misaligned.
<p>5. Lock Nuts</p>  <p>Starts with heavy resistance that last through entire travel until screw or nut seats. Then either (A) gradual, or (B) sudden further build-up resistance.</p>	Excellent for all size screws.	Good for most screws. Close torque control is not required.	Good for large and medium screws. Must be adjusted to run rather slowly for small screws.	Fair for all size screws.
<p>6. Wood Screws</p>  <p>Starts with small resistance that steadily increases through entire travel with additional resistance as screw head seats.</p>	Fair for all size screws.	Good for all size screws.	Excellent for large and medium screws. Must be adjusted to run rather slowly for small screws.	Excellent for all size screws.

Tool Selection Guide

Considerations for Selecting Screwdrivers

This should be done in a systematic way to ensure no details are overlooked that could have an adverse affect on job function or results. The following are variables that must be considered to ensure proper tool selection.

- What is being assembled?
- What material is involved?
- What type of screw or nut is being driven? What head type?
- What screw size (standard or metric)?
- What U.S. grade or metric class?
- What torque (inch pounds or Newton meters)?
- What torque tolerance (accuracy)?
- What is the run-down torque vs. seating torque?
- What type of joint pull-up (hard, medium, soft)?
- What pull-up conditions (free run-down, sheet metal, wood, or plastic)?
- What is the production rate?
- Are there clearance problems?
- What handle style is required (straight or pistol)?
- Is the tool to be hand held or fixtured?
- What type of clutch?
- Speed required?
- Is there a need for a reversible tool?
- What type of drive (square, 1/4" hex, quick change)?
- How is the application being done now?
- Special consideration?

What is the size and type of screw or fastener on which the tool will be used?

- .4 Series Tools** – 2 to 60 in lb of torque. (Fasteners up to 1/4")
- .6 & 1 HP Signature Series Tools** – 5 to 400 in lbs of torque. (Fasteners up to 3/8")
- No 3 Series Tools** – 5 to 50 ft lbs of torque. (Fasteners up to 1/2")

What kind of application and material will the fastener be used on?

The type of material helps to determine which type of clutch is needed.

Application & Material Guide

Screw Size	Clutch			
	Clutch	Free Run Down	Soft Pull-Up	Prevailing Torque
No 8 and Smaller				
	Adjustable	Excellent	Excellent	Excellent
	Stall	Excellent	Good	Excellent
	Direct	Good	Good	Good
	Positive	Fair	Fair	Good
No 10 and Larger				
	Adjustable	Good	Fair	Fair
	Stall	Good	Excellent	Excellent
	Direct	Good	Excellent	Excellent
	Positive "P"	Good	Excellent	Excellent
	Positive "PS"	Good	Excellent	Excellent

What are the torque requirements?

Most air tools share the quality: as the speed increases, the torque decreases. This applies to tools within the same horsepower rating.

- A.** Stall or direct clutch gives the most torque.
- B.** Positive clutch tools are operator influenced.
- C.** Adjustable torque clutches are available on most Sioux fastening tools.
- D.** Torque control is available on No 1

At what angle or position will the tool be used?

This will determine the style of tool best suited from an ergonomics point of view.

- A.** If the fastener is in a vertical position, a straight or lever style tool will be best.
- B.** If the fastener is in a horizontal position a pistol style tool will be best.
- C.** If the fastener is in a tight or constricted area the "2S" series works well in this application.

Is reversing necessary?

Most fastening applications are going to require a reversible tool. Keep in mind that in most cases a non-reversing tool will have more torque than a reversible tool.

Is the application operator influenced or restricted?

- A.** Is the operator male or female? This can be a factor in determining the size of the power tool (weight for example).
- B.** Does the application lend itself to an auto start tool, as in the No 1 series?

An example of applying these questions to an application would be:

Driving a 2" long wood screw into hardwood with a pilot hole. The fastener is in a horizontal position during assembly. A test with a hand torque wrench indicates a prevailing torque of 80 in lbs, and a failing torque of 120 in lbs.

- 1.** 2" long wood screw
- 2.** Hard Wood use positive clutch
- 3.** SSD10P20PS – 100 in lbs
- 4.** Pistol will work best
- 5.** Need reversing
- 6.** Mostly male workers

Screwdriver Maintenance

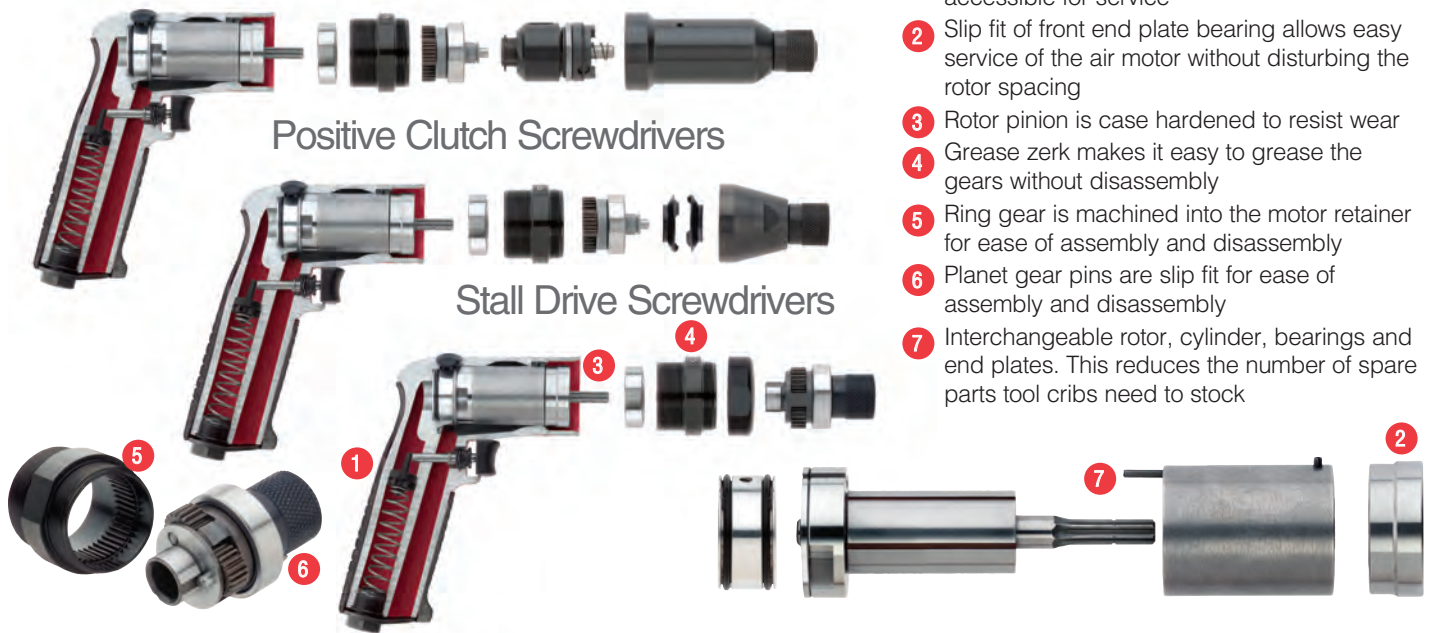

- 1 Tipper valve and valve seat is easily accessible for service
- 2 Slip fit of front end plate bearing allows easy service of the air motor without disturbing the rotor spacing
- 3 Rotor pinion is case hardened to resist wear
- 4 Grease zerk makes it easy to grease the gears without disassembly
- 5 Ring gear is machined into the motor retainer for ease of assembly and disassembly
- 6 Planet gear pins are slip fit for ease of assembly and disassembly
- 7 Interchangeable rotor, cylinder, bearings and end plates. This reduces the number of spare parts tool cribs need to stock

Guide to Fasteners

Guide To Fasteners

Screw Type	Standard Nosepieces Available For All Fasteners Shown Below
------------	---

Wood Screws



Machine Screws

* Standard or Special, depending on the washer diameter.



Tapping or Sheet Metal Screws



Drive Systems

* Special bits required for Clutch and Torx internal and external. Call factory.

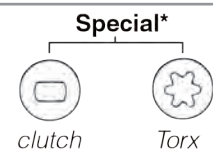
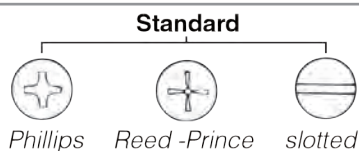

POSITIVE CLUTCH PISTOL GRIP & T-HANDLE SCREWDRIVERS



Performance:

Torque: 20 in lb (2.3 Nm) – 216 in lb (24.4 Nm)
 Speed: 500 rpm – 2,500 rpm

Features:

Reversible and Non-reversible
 Trigger or Shuttle Reverse
 Comfort Grip

Positive Clutch Pistol Grip & T-Handle Screwdrivers



Model Number	Max Torque ¹ (Soft Joint)		Free Speed rpm	Weight		Length		Side To Center		Air Consumption	
	in lb	Nm		lb	kg	in	mm	in	mm	scfm	l/s
0.4 hp (0.3 kW) Trigger Start - Shuttle Reverse											
SSD4P5P	95	10.7	500	1.8	0.8	7.0	178	0.7	17	20	10
SSD4P7P	65	7.3	700	1.8	0.8	7.0	178	0.7	17	20	10
SSD4P11P	45	5.1	1100	1.8	0.8	7.0	178	0.7	17	20	10
SSD4P14P	35	3.9	1400	1.6	0.7	6.5	165	0.7	17	20	10
SSD4P18P	26	2.9	1800	1.6	0.7	6.5	165	0.7	17	20	10
SSD4P26P	20	2.3	2600	1.6	0.7	6.5	165	0.7	17	20	10
0.4 hp (0.3 kW) Trigger Start - Shuttle Reverse											
SSD4P18PRR	26	2.9	1800	1.6	0.7	6.5	165	0.7	17	20	10
SSD4P26PRR	20	2.3	2600	1.6	0.7	6.5	165	0.7	17	20	10
0.6 hp (0.45 kW) Medium Clutch Screwdrivers – 1/4" Quick Change											
SSD6P12P	100	11.3	1200	2.6	1.18	8.6	218	0.8	20	25	12
SSD6P20P	55	6.2	2000	2.2	0.98	6.8	171	0.8	20	25	12
SSD6P20PSRR	55	6.2	2000	2.2	0.98	6.8	171	0.8	20	25	12
SSD6P25P	40	4.5	2500	2.2	0.98	6.8	171	0.8	20	25	12
SSD6P25PSRR	40	4.5	2500	2.2	0.98	6.8	171	0.8	20	25	12
1 hp (0.75 kW) Medium Torque Clutch Screwdrivers – 1/4" Quick Change											
SSD10P12P	135	15.3	1200	2.8	1.30	9.1	231	0.8	20	30	14
SSD10P20P	70	7.9	2000	2.4	1.07	7.3	185	0.8	20	30	14
SSD10P25P	50	5.7	2500	2.4	1.07	7.3	185	0.8	20	30	14
1 hp (0.75 kW) High Torque Clutch Screwdrivers – 1/4" Quick Change											
SSD10P12PS	145	16.4	1200	2.8	1.30	9.1	231	0.8	20	30	14
SSD10P20PS	80	9.0	2000	2.4	1.07	7.3	185	0.8	20	30	14
SSD10P25PS	58	6.5	2500	2.4	1.07	7.3	185	0.8	20	30	14
1 hp (0.75 kW) – Medium Torque Positive Clutch Rapid Reverse Screwdriver											
SSD10P20PRR	70	7.9	2000	2.4	1.07	7.3	185	0.8	20	30	14
SSD10P25PRR	50	5.7	2500	2.4	1.07	7.3	185	0.8	20	30	14
3 Series T-Handle – 7/16" Quick Change											
3T2303 ¹	216	24.4	850	6.7	3.0	33	840	1	25	33	16

¹ Torque output varies with force exerted by operator

General: Air Inlet Size: 1/4" NPT • Recommended Hose Size: 3/8" (10 mm) • Performance rated @ 90 psig (6.2 bar) air pressure

Standard Equipment: Parts List • Safety and Instruction Manual

Accessories: Screwdriver Accessories, see page 41



SAFETY PRECAUTION: Read and follow all safety and operating instructions.
WARNING: Face & eye protection must be worn while operating power tools, per ANSI B186.1

POSITIVE CLUTCH INLINE SCREWDRIVER

Performance:

Torque: 55 in lb (6.2 Nm)
Speed: 800 rpm

Features:

Reversible
Lever Start
Rear Exhaust

Positive Clutch Inline Screwdrivers



Model Number	Max Torque ¹ (Soft Joint)		Free Speed rpm	Weight		Length		Side To Center		Air Consumption	
	in lb	Nm		lb	kg	in	mm	in	mm	scfm	l/s
Inline											
1SM2103	55	6.2	800	1.4	0.6	9.1	231	0.6	15	8	4

¹ Torque output varies with force exerted by operator
General: Air Inlet Size: 1/4" NPT • Recommended Hose Size: 1/4" (6 mm)
Performance rated @ 90 psig (6.2 bar) air pressure
Standard Equipment: Parts List • Safety and Instruction Manual • Comfort Grip
Accessories: Screwdriver Accessories, see page 41



1SM2103

STALL PISTOL GRIP SCREWDRIVERS

Performance:

Torque: 20 in lb (2.3 Nm) –
400 in lb (45.2 Nm)
Speed: 300 rpm – 2,600 rpm

Features:

Reversible
Rapid or Shuttle Reverse
Comfort Grip
1/4" Quick Change

Stall Pistol Grip Screwdrivers



Model Number	Max Torque (Soft Joint)		Free Speed rpm	Weight		Length		Side To Center		Air Consumption	
	in lb	Nm		lb	kg	in	mm	in	mm	scfm	l/s
0.4 hp (0.3 kW) Trigger Start - Shuttle Reverse											
SSD4P5S	95	10.7	500	1.5	0.7	5.5	140	0.7	17	20	10
SSD4P7S	65	7.3	700	1.5	0.7	5.5	140	0.7	17	20	10
SSD4P11S	45	5.1	1100	1.5	0.7	5.5	140	0.7	17	20	10
SSD4P14S	35	3.9	1400	1.3	0.6	5.0	127	0.7	17	20	10
SSD4P18S	26	2.9	1800	1.3	0.6	5.0	127	0.7	17	20	10
SSD4P26S	20	2.3	2600	1.3	0.6	5.0	127	0.7	17	20	10
0.4 hp (0.3 kW) Trigger Start – Rapid Reverse											
SSD4P18SRR	26	2.9	1800	1.3	0.6	5.0	127	0.7	17	20	10
SSD4P26SRR	20	2.3	2600	1.3	0.6	5.0	127	0.7	17	20	10
0.6 hp (0.45 kW) Trigger Start – Shuttle Reverse											
SSD6P7S	155	17.8	700	2.4	1.10	6.8	171	0.8	20	25	12
SSD6P12S	100	11.3	1200	2.4	1.10	6.8	171	0.8	20	25	12
SSD6P20S	55	6.2	2000	2.0	0.90	5.8	146	0.8	20	25	12
SSD6P25S	40	4.5	2500	2.0	0.90	5.8	146	0.8	20	25	12
0.6 hp (0.45 kW) Trigger Start – Rapid Reverse											
SSD6P20SRR	55	6.2	2000	2.0	0.90	5.8	146	0.8	20	25	12
1 hp (0.75 kW) Trigger Start – Shuttle Reverse											
SSD10P3S	400	45.2	300	2.6	1.17	7.5	191	0.8	20	30	14
SSD10P5S	325	36.7	500	2.6	1.17	7.5	191	0.8	20	30	14
SSD10P7S	220	24.9	700	2.6	1.17	7.5	191	0.8	20	30	14
SSD10P12S	145	16.4	1200	2.6	1.17	7.5	191	0.8	20	30	14
SSD10P20S	80	9.0	2000	2.2	0.98	6.5	165	0.8	20	30	14
SSD10P25S	58	6.6	2500	2.2	0.98	6.5	165	0.8	20	30	14
1 hp (0.75 kW) – Stall Rapid Reverse											
SSD10P20SRR	80	9.0	2000	2.2	0.98	6.5	165	0.8	20	30	14

General: Air Inlet Size: 1/4" NPT • Recommended Hose Size: 3/8" (10 mm)
Performance rated @ 90 psig (6.2 bar) air pressure
Standard Equipment: Parts List • Safety and Instruction Manual • Comfort Grip
Accessories: Screwdriver Accessories, see pages 41



SSD4P26S



SSD6P20S



SSD10P20SRR



SSD10P20S



SAFETY PRECAUTION: Read and follow all safety and operating instructions.
WARNING: Face & eye protection must be worn while operating power tools, per ANSI B186.1

STALL INLINE SCREWDRIVERS

Performance:

Torque: 24 in lb (2.7 Nm) –
400 in lb (45.2 Nm)
Speed: 300 rpm – 2,500 rpm

Features:

Reversible
Lever Start
Rear Exhaust
Suspension Bail
1/4" Quick Change

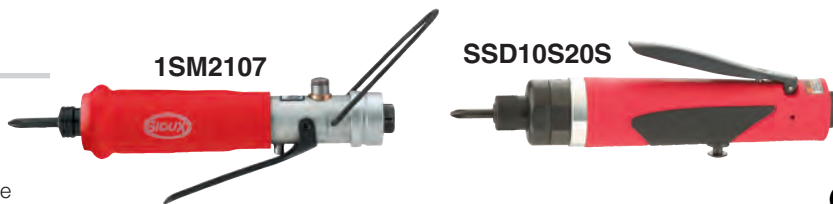

Stall Inline Screwdrivers

Model Number	Max Torque (Soft Joint)		Free Speed rpm	Weight		Length		Side To Center		Air Consumption	
	in lb	Nm		lb	kg	in	mm	in	mm	scfm	l/s
Inline – Reversible – 1/4" Quick Change Drive											
1SM2107	55	6.2	800	1.4	0.60	9.1	231	0.6	15	8	4
1SM2407	24	2.7	2200	1.3	0.60	8.1	206	0.6	15	8	4
Inline – Stall Clutch											
SSD10S3S	400	45.2	300	2.2	1.00	9.5	240	0.8	20	30	14
SSD10S5S	325	36.7	500	2.2	1.00	9.5	240	0.8	20	30	14
SSD10S7S	220	24.9	700	2.2	1.00	9.5	240	0.8	20	30	14
SSD10S12S	145	16.4	1200	2.2	1.00	9.5	240	0.8	20	30	14
SSD10S20S	80	9.0	2000	1.9	0.85	8.4	215	0.8	20	30	14
SSD10S25S	58	6.6	2500	1.9	0.85	8.4	215	0.8	20	30	14

General: Air Inlet Size: 1/4" NPT • Recommended Hose Size: 1/4" (6 mm) (1SM series); 3/8" (10 mm) (SSD series) • Performance rated @ 90 psig (6.2 bar) air pressure

Standard Equipment: Parts List • Safety and Instruction Manual • Comfort Grip (1SM series) • Suspension Bail

Accessories: Screwdriver Accessories, see page 41



SAFETY PRECAUTION: Read and follow all safety and operating instructions.
WARNING: Face & eye protection must be worn while operating power tools, per ANSI B186.1

ADJUSTABLE CLUTCH PISTOL GRIP SCREWDRIVERS



SSD4P26AC



SSD6P20AC



SSD10P20AC



Performance:

Torque: 17 in lb (1.9 Nm) – 140 in lb (15.8 Nm)
 Speed: 300 rpm – 2,600 rpm

Features:

- Reversible
- Rapid or Shuttle Reverse
- Comfort Grip

Adjustable Clutch Pistol Grip Screwdrivers

Model Number	Max Torque (Soft Joint)		Free Speed rpm	Weight		Length		Side To Center		Air Consumption	
	in lb	Nm		lb	kg	in	mm	in	mm	scfm	l/s
0.4 hp (0.3 kw) Trigger Start - Shuttle Reverse											
SSD4P5AC	60	6.8	500	2.1	1.0	8.5	216	0.7	17	20	10
SSD4P7AC	60	6.8	700	2.1	1.0	8.5	216	0.7	17	20	10
SSD4P11AC	40	4.5	1100	2.1	1.0	8.5	216	0.7	17	20	10
SSD4P14AC	30	3.4	1400	1.9	0.9	8.0	203	0.7	17	20	10
SSD4P18AC	23	2.6	1800	1.9	0.9	8.0	203	0.7	17	20	10
SSD4P26AC	17	1.9	2600	1.9	0.9	8.0	203	0.7	17	20	10
0.6 hp (0.45 kW) Trigger Start – Shuttle Reverse											
SSD6P7AC	140	15.8	700	3.0	1.36	10.3	262	0.8	20	25	12
SSD6P12AC	100	11.3	1200	3.0	1.36	10.3	262	0.8	20	25	12
SSD6P20AC	55	6.2	2000	2.6	1.16	8.5	216	0.8	20	25	12
SSD6P25AC	40	4.5	2500	2.6	1.16	8.5	216	0.8	20	25	12
1 hp (0.75 kW) Trigger Start – Shuttle Reverse											
SSD10P3AC	140	15.8	300	3.2	1.45	10.2	259	0.8	20	30	14
SSD10P5AC	140	15.8	500	3.2	1.45	10.2	259	0.8	20	30	14
SSD10P7AC	140	15.8	700	3.2	1.45	10.2	259	0.8	20	30	14
SSD10P12AC	120	13.5	1200	3.2	1.45	10.2	259	0.8	20	30	14
SSD10P20AC	80	9.0	2000	2.8	1.25	8.4	213	0.8	20	30	14
SSD10P25AC	60	6.8	2500	2.8	1.25	8.4	213	0.8	20	30	14

General: Air Inlet Size: 1/4" NPT • Recommended Hose Size: 3/8" (10 mm) • Performance rated @ 90 psig (6.2 bar) air pressure
Standard Equipment: Parts List • Safety and Instruction Manual • Comfort Grip • Clutch Adjustment Wrench • Applicable Clutch Springs
Accessories: Screwdriver Accessories, see page 41



SAFETY PRECAUTION: Read and follow all safety and operating instructions.
WARNING: Face & eye protection must be worn while operating power tools, per ANSI B186.1

ADJUSTABLE CLUTCH INLINE SCREWDRIVERS

Performance:

Torque: 20 in lb (2.3 Nm) – 140 in lb (15.8 Nm)
 Speed: 300 rpm – 2,500 rpm

Features:

Reversible
 Rear Exhaust
 External Clutch Adjustment



Adjustable Clutch Inline Screwdrivers



Model Number		Max Torque (Soft Joint)		Free Speed	Weight		Length		Side To Center		Air Consumption	
1/4" Quick Change	1/4" Internal Hex	in lb	Nm	rpm	lb	kg	in	mm	in	mm	scfm	l/s
Inline – Lever Start												
		50	5.7	800	1.6	0.70	10.3	262	0.6	15	8	4
		35	4.0	1100	1.6	0.70	10.3	262	0.6	15	8	4
		25	2.8	1500	1.6	0.70	10.3	262	0.6	15	8	4
	1SM2405Q	20	2.3	2200	1.4	0.60	9.3	236	0.6	15	8	4
Inline – Lever Start												
		140	15.8	300	2.8	1.25	12.3	315	0.8	20	30	14
		140	15.8	500	2.8	1.25	12.3	315	0.8	20	30	14
		140	15.8	700	2.8	1.25	12.3	315	0.8	20	30	14
		120	13.5	1200	2.8	1.25	12.3	315	0.8	20	30	14
		80	9.0	2000	2.5	1.15	11.2	285	0.8	20	30	14
		60	6.8	2500	2.5	1.15	11.2	285	0.8	20	30	14

General: Air Inlet Size: 1/4" NPT • Recommended Hose Size: 1/4" (6 mm) (1SM series); 3/8" (10 mm) (SSD series) • Performance rated @ 90 psig (6.2 bar) air pressure
Standard Equipment: Parts List • Safety and Instruction Manual • Comfort Grip (1SM series) • Suspension Bail • Clutch Adjustment Wrench • Applicable Clutch Springs
Accessories: Screwdriver Accessories, see page 41



SAFETY PRECAUTION: Read and follow all safety and operating instructions.
WARNING: Face & eye protection must be worn while operating power tools, per ANSI B186.1

TORQUE CONTROL SCREWDRIVERS

Performance:

Torque: 5 in lb (0.6 Nm) – 50 in lb (5.5 Nm)
 Speed: 725 rpm – 2,800 rpm

Features:

- Push-to-Start
- Reversible
- Locking Button Reverse
- External Clutch Adjustment

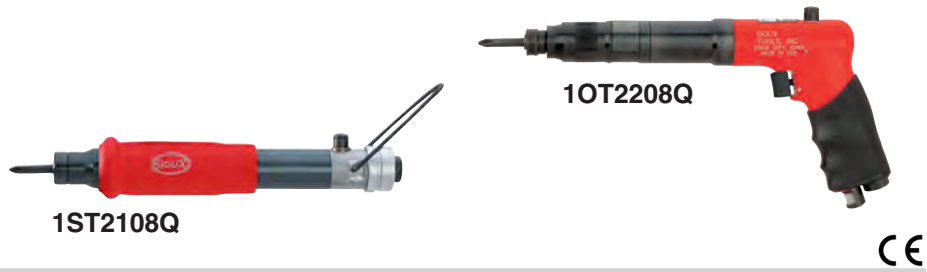

Torque Control Screwdrivers

Model Number	Max Torque (Soft Joint)		Free Speed	Weight		Length		Side To Center		Air Consumption	
	in lb	Nm		lb	kg	in	mm	in	mm	scfm	l/s
1/4" Quick Change											
Inline – Push To Start											
1ST2108Q	5-50	0.6-5.5	800	1.6	0.7	9.3	236	0.6	15	8	4
1ST2208Q	5-35	0.6-4	1100	1.6	0.7	9.3	236	0.6	15	8	4
1ST2308Q	5-25	0.6-3	1500	1.6	0.7	9.3	236	0.6	15	8	4
1ST2508Q	5-14	0.6-1.5	2800	1.4	0.6	8.3	211	0.6	15	8	4
Pistol Grip – Push To Start											
1OT2108Q	5-50	0.6-5.5	725	2.1	1.0	8.8	225	0.7	17	10	5
1OT2208Q	5-35	0.6-4	1000	2.1	1.0	8.8	225	0.7	17	10	5
1OT2308Q	5-25	0.6-3	1400	2.1	1.0	8.8	225	0.7	17	10	5
1OT2508Q	5-14	0.6-1.5	2600	1.9	0.9	7.8	200	0.7	17	10	5

General: Air Inlet Size: 1/4" NPT • Recommended Hose Size: 1/4" (6 mm) (1OT, 1ST series) • Performance rated @ 90 psig (6.2 bar) air pressure
Standard Equipment: Parts List • Safety and Instruction Manual • Comfort Grip • Suspension Bail (Inline models) • All Applicable Clutch Springs
Accessories: Screwdriver Accessories, see page 41



SAFETY PRECAUTION: Read and follow all safety and operating instructions.
WARNING: Face & eye protection must be worn while operating power tools, per ANSI B186.1

RIGHT ANGLE SCREWDRIVERS



1AM2105



1AM2101

1.3"



SSD10A10S

2.63"

Performance:

Torque: 35 in lb (4 Nm) –
400 in lb (45.2 Nm)
Speed: 300 rpm – 2,000 rpm

Features:

Stall Drive & Adjustable Clutch
Button Reverse
Lever Start
Rear Exhaust

Right Angle Screwdrivers



Model Number		Max Torque (Soft Joint)		Free Speed	Weight		Length		Side To Center		Air Consumption	
1/4" Quick Change	1/4" Internal Hex	in lb	Nm	rpm	lb	kg	in	mm	in	mm	scfm	l/s
Stall Drive												
	1AM2101	50	5.7	800	1.5	0.70	10.0	254	0.3	8	8	4
	1AM2201	35	4.0	1100	1.5	0.70	10.0	254	0.3	8	8	4
Stall Drive												
	SSD10A3S	400	45.2	300	3.4	1.50	12.0	305	0.8	20	30	14
	SSD10A5S	325	36.7	500	3.4	1.50	12.0	305	0.8	20	30	14
	SSD10A6S	220	24.9	600	3.4	1.50	12.0	305	0.8	20	30	14
	SSD10A10S	145	16.4	1000	3.4	1.50	12.0	305	0.8	20	30	14
	SSD10A16S	80	9.0	1600	3.0	1.35	11.0	280	0.8	20	30	14
	SSD10A20S	58	6.6	2000	3.0	1.35	11.0	280	0.8	20	30	14
Adjustable Clutch												
	1AM2105	50	5.7	800	1.9	0.90	11.8	300	0.3	8	8	4
	1AM2205	35	4.0	1100	1.9	0.90	11.8	300	0.3	8	8	4

General: Air Inlet Size: 1/4" NPT • Recommended Hose Size: 1/4" (6 mm) (1AM series); 3/8" (10 mm) (SSD series) • Performance rated @ 90 psig (6.2 bar) air pressure

Standard Equipment: Comfort Grip (1AM series)

Accessories: Screwdriver Accessories, see page 41



SAFETY PRECAUTION: Read and follow all safety and operating instructions.
WARNING: Face & eye protection must be worn while operating power tools, per ANSI B186.1

RIGHT ANGLE NUTRUNNERS



3A2104



1AM2106



SNR10A10S

Performance:

Torque: 50 in lb (5.7 Nm) –
600 in lb (68 Nm)
Speed: 300 rpm – 2,000 rpm

Features:

Reversible
Lever Start
Rear and Side Exhaust

Right Angle Nutrunners



Model Number	Bolt Capacity ²		Max Torque (Soft Joint)		Free Speed rpm	Weight		Length		Side To Center		Drive Size	
	in	mm	in lb	Nm		lb	kg	in	mm	in	mm	in	mm
Torque Control Clutch													
3A2108 ¹	3/8	M10	360	41	300	7.4	3.40	18.3	465	0.8	20	1/2	13
3A2208 ¹	3/8	M10	294	33	480	7.4	3.40	18.3	465	0.8	20	1/2	13
Adjustable Clutch													
1AM2106	#10	M4.5	50	5.7	800	1.9	0.90	11.6	295	0.3	8	1/4	6
Stall Drive													
1AM2102	#10	M4.5	50	5.7	800	1.5	0.70	11.5	292	0.3	8	1/4	6
Stall Drive													
3A2102 ¹	7/16	M11	600	68	300	6.2	2.81	17.8	452	0.8	20	1/2	13
3A2104 ¹	7/16	M11	600	68	300	5.5	2.50	15.5	394	0.8	20	1/2	13
Stall Drive													
SNR10A3S	3/8	M10	400	45.2	300	2.9	1.30	12.0	305	0.8	20	3/8	10
SNR10A5S	3/8	M10	325	36.7	500	2.9	1.30	12.0	305	0.8	20	3/8	10
SNR10A6S	3/8	M10	220	24.9	600	2.9	1.30	12.0	305	0.8	20	3/8	10
SNR10A10S	5/16	M8	145	16.4	1000	2.9	1.30	12.0	305	0.8	20	3/8	10
SNR10A16S	1/4	M6	80	9.0	1600	2.6	1.15	11.0	280	0.8	20	3/8	10
SNR10A20S	#10	M4.5	58	6.6	2000	2.6	1.15	11.0	280	0.8	20	1/4	6

¹ Not CE Certified

² Bolt capacities are based on suggested assembly torques applied to SAE Grade 5 and metric Class 9.8 fasteners under slightly lubricated conditions.

General: Air Inlet Size: 1/4" NPT • Recommended Hose Size: 1/4" (6 mm) (1AM series); 3/8" (10 mm) (SNR, 3A series) • Performance rated @ 90 psig (6.2 bar) air pressure

Standard Equipment: Parts List • Safety and Instruction Manual • Comfort Grip (1AM series) • Clutch Adjustment Wrench

Accessories: Nutrunner Accessories, see page 41



SAFETY PRECAUTION: Read and follow all safety and operating instructions.

WARNING: Face & eye protection must be worn while operating power tools, per ANSI B186.1

RATCHET WRENCHES

Performance:

Power: 0.3 hp (0.25 kW)
Torque: 35 ft lb (47 Nm)

Features:

Lever Start
Teasing Throttle
Comfort Grip



SRW03S-25

Ratchet Wrenches

Model Number	Drive Size		Torque		Free Speed	Weight		Length		Side to Center		Air Consumption		Exhaust
	in	mm	ft lb	Nm	rpm	lb	kg	in	mm	in	mm	scfm	l/s	
0.3 hp (0.25 kW)														
SRW03S-25	1/4"	6	35	47	235	1.4	0.6	7.7	197	1.1	28	11	5.2	Rear
SRW03S-38	3/8"	10	35	47	235	1.4	0.6	7.7	197	1.1	28	11	5.2	Rear
SRW03S-38Q	3/8"	10	35	47	235	1.4	0.6	7.7	197	1.1	28	11	5.2	Rear

General:

Air Inlet Size: 1/4" NPT • Recommended Hose Size: 3/8" (10 mm) • Performance rated @ 90 psig (6.2 bar) air pressure

Standard Equipment:

Parts List • Safety and Instruction Manual • Boot for Head

Accessories:

Ratchet Accessories, see page 41



SRW07-38

Performance:

Power: 0.7 hp (0.52 kW)
Torque: 65 ft lb (88 Nm)

Ratchet Wrenches

Model Number	Drive Size		Torque		Free Speed	Weight		Length		Side to Center		Air Consumption		Exhaust
	in	mm	ft lb	Nm	rpm	lb	kg	in	mm	in	mm	scfm	l/s	
0.7 hp (0.52 kW)														
SRW07-38	3/8"	10	65	88	260	3.0	1.3	11.8	300	1.0	25	30	14	Front
SRW07-50	1/2"	13	65	88	260	3.0	1.3	11.8	300	1.0	25	30	14	Front

General:

Air Inlet Size: 1/4" NPT • Recommended Hose Size: 3/8" (10 mm) • Performance rated @ 90 psig (6.2 bar) air pressure

Standard Equipment:

Parts List • Safety and Instruction Manual • Boot for Head

Accessories:

Ratchet Accessories, see page 41



SAFETY PRECAUTION: Read and follow all safety and operating instructions.
WARNING: Face & eye protection must be worn while operating power tools, per ANSI B186.1

ASSEMBLY

We're Making A Big Impact

Impact wrenches are the true workhorses of industrial power tools. These incredibly powerful tools make easy work of any job in a variety of applications. Before the creation of impact tools, workers had to manually strike a hammer against a hand wrench in order to loosen or tighten nuts or bolts. They could only manage a few blows per minute. But today's impact wrenches can exert more powerful blows, and some can produce over 2000 blows per minute. This is accomplished by using the energy of compressed air and converting the motor's torque into a rapid series of powerful rotary impacts.

Choice of Configuration

Sioux Tools offers Industrial and Force Impact Wrenches and Impact Drivers in a wide variety of configurations to meet your specific applications. In order to select the correct impact tool for your job requirements, you must take into account several factors including fastener size and grade, required torque output, and accessibility. Choosing the right mix of features such as handle configuration, type of retainer, torque output, anvil length, and drive size will make operators more productive, with less risk of discomfort and/or injury.

Industrial Impact Tools

Built to a higher level of quality, Sioux Industrial Impact Wrenches and Impact Drivers are built a step above the standard. Manufactured from the highest quality materials, and utilizing the most advanced motor and clutch designs, these tools are constructed to hold up under continuous use in the toughest working environments.

Our extensive lineup of impact tools includes a wide selection of important features including:

- Ball & Cam or Twin Hammer impact mechanisms
- Inline, pistol grip, or D-handle configurations
- Pin, friction ring, quick change, or thru hole socket retainers
- Standard or extended anvils

In addition, Sioux offers a wide range of performance levels and characteristics to ensure a perfect match to your application. With drive sizes ranging from 1/4" (6 mm) to 1-1/2" (38 mm), and torque outputs up to 2500 ft lb (3390 Nm), finding the tool to meet your performance requirements will be simple.

Impact Wrench Principles of Operation

An impact wrench delivers a series of rotary blows to a fastener, producing torque.

The action of the torque creates clamp force in an assembly.

Interaction of the motor, clutch and drive-end determine the type of application an impact wrench can handle.

The advantages of impact wrenches are a high power-to-weight ratio, fast rundown, and no torque reaction to operator.

Class of Service

High production – automobile assembly plants, farm and construction equipment, etc.

Low production – large machinery assembly

Maintenance or repair work

Job Conditions

Hard pull-up – rigid joint

Soft pull-up – spring joint

Run-down – free running, or prevailing torque (lock nut, self threading screw)

Material

Metal-to-metal

Metal/gasket

Rubber or plastic

Assembly Method

General tightening – operator judgement

Turn-of-the-nut – permanent assemblies (steel erection and construction equipment)

Note: If it takes five seconds or longer to reach final tightness, a larger wrench should be used.

IMPACT DRIVERS

Performance:

Torque: 10 ft lb (13 Nm) – 70 ft lb (270 Nm)
 Drive Size: 1/4" QC & 3/8"
 Working Torque up to 70 ft-lb

Features:

Pistol Grip
 Belt Clip



IW38TBP-2Q



IW38TBP-3P

1/4" QC & 3/8" Impact Drivers

Model Number	Drive Size	Working Torque Range ¹		Maximum Torque		Blows Per Minute	Free Speed	Weight		Length		Side To Center		Air Consumption		Socket Retainer Style
	in	ft lb	Nm	ft lb	Nm		rpm	lb	kg	in	mm	in	mm	scfm	l/s	
IW38TBP-2Q	1/4 QC	10-70	13-95	70	95	2000	8000	2.1	1.0	6.3	160	0.9	22	20	9	QC
IW38TBP-3P	3/8	10-70	13-95	70	95	2000	8000	2.1	1.0	6.3	160	0.9	22	20	9	Pin



¹ Maximum working torque determined by 5 second rundown on appropriate Skidmore-Wilhelm Torque-Tension Tester.
General: Air Inlet Size: 1/4" NPT • Recommended Hose Size: 3/8" (10 mm) • Performance rated @ 90 psig (6.2 bar) air pressure
Standard Equipment: Parts List • Safety and Instruction Manual • Suspension Bail
Accessories: Impact Wrench Accessories, see page 41



ID375AP-2Q



ID375AP-2QRR



IW375AP-3P



3/8" Pinned Anvil



3/8" Friction Ring Anvil

Key Features:

High power to weight ratio
 High impact rate of 5,000 blows per minute
 Working torque range up to 95 ft-lb
 Smooth Impacting that creates minimal torque reaction
 Includes rubber boot for hammer case

Applications:

Wood Screws
 Self-tapping screws
 Lag bolts
 High prevailing torque applications



1/4" Quick Change

1/4" QC & 3/8" Impact Drivers

Model Number	Drive Size	Working Torque Range ¹		Maximum Torque		Blows Per Minute	Free Speed	Weight		Length		Side To Center		Air Consumption		Socket Retainer Style
	in	ft lb	Nm	ft lb	Nm		rpm	lb	kg	in	mm	in	mm	scfm	l/s	
ID375AP-2Q	1/4 QC	10-55	13-75	60	80	5000	4000	2.5	1.1	8.5	216	0.85	21	25	12	Quick Change
ID375AP-2QRR	1/4 QC	10-55	13-75	60	80	5000	4000	2.5	1.1	8.5	216	0.85	21	25	12	Quick Change
IW375AP-3P	3/8	10-95	13-130	100	135	5000	4000	2.5	1.1	8.5	216	0.85	21	25	12	Pin
IW375AP-3F	3/8	10-95	13-130	100	135	5000	4000	2.5	1.1	8.5	216	0.85	21	25	12	Ring



¹ Maximum working torque determined by 5 second rundown on appropriate Skidmore-Wilhelm Torque-Tension Tester.
General: Air Inlet Size: 1/4" NPT • Recommended Hose Size: 3/8" (10 mm) • Performance rated @ 90 psig (6.2 bar) air pressure
Standard Equipment: Parts List • Safety and Instruction Manual
Accessories: Impact Wrench Accessories, see page 41



SAFETY PRECAUTION: Read and follow all safety and operating instructions.
WARNING: Face & eye protection must be worn while operating power tools, per ANSI B186.1

1/2" IMPACT WRENCHES



IW500MP-4R



IW500MP-4R3



IW500MP-4PT
Tethered



IW500MP-7Q

Performance:

Working Torque: 100 ft lb (135 Nm) – 625 ft lb (1058 Nm)
 Drive Size: 7/16" QC – 1/2"
 Bolt Capacity: 9/16" (14 mm) – 5/8" (16 mm)

Features:

High power to weight ratio
 Forged Aluminum Anvil Housing
 One Hand Forward/Reverse Operation

1/2" Impact Wrenches



Model Number	Drive Size		Bolt Cap Grade 5		Working Torque Range ¹		Maximum Torque		Blows Per Minute	Free Speed rpm	Weight		Length		Side To Center		Air Consumption		Socket Retainer Style
	in	mm	in	mm	ft lb	Nm	ft lb	Nm			lb	kg	in	mm	in	mm	scfm	l/s	
IW500MP-4R	1/2	16	5/8	16	100-625	135-845	780	1058	1200	9400	4.2	1.9	7.0	178	1.5	38	28	13	Ring
IW500MP-4R3	1/2	16	5/8	16	100-625	135-845	780	1058	1200	9400	4.4	2.0	10.0	254	1.5	38	28	13	Ring
IW500MP-4P	1/2	16	5/8	16	100-625	135-845	780	1058	1200	9400	4.2	1.9	7.0	178	1.5	38	28	13	Pin
IW500MP-4P3	1/2	16	5/8	16	100-625	135-845	780	1058	1200	9400	4.4	2.0	10.0	254	1.5	38	28	13	Pin
IW500MP-4PT	1/2	16	5/8	16	625	845	780	1058	1200	9400	4.3	1.9	7.0	178	1.6	40	28	13	Pin
IW500MP-7Q	7/16 QC	14	9/16	14	80-500	110-675	600	810	1200	9400	4.3	2.0	7.4	188	1.5	38	28	13	QC

¹ Maximum working torque determined by 5 second rundown on appropriate Skidmore-Wilhelm Torque-Tension Tester.

General: Air Inlet Size: 1/4" NPT • Recommended Hose Size: 3/8" (10 mm) • Performance rated @ 90 psig (6.2 bar) air pressure

Standard Equipment: Parts List • Safety and Instruction Manual

Accessories: Impact Wrench Accessories, see page 41



SAFETY PRECAUTION: Read and follow all safety and operating instructions.

WARNING: Face & eye protection must be worn while operating power tools, per ANSI B186.1

3/4" & 1" IMPACT WRENCHES



IW750MP-6P



IW750MP-6PT



IW75BP-6H

Performance:

Maximum Torque: 1,000 ft lb (1356 Nm) – 1,100 ft lb (1492 Nm)
 Drive Size: 3/4" – 1"

Features:

- One hand Forward / Reverse operation
- Long-life Impact mechanism
- Aluminum nose
- Lightweight Aluminum / Composite (IW750)
- Heavy Duty Steel / Aluminum (IW75)

Heavy Duty Impact Wrenches



Model Number	Drive Size			Bolt Cap Grade 5		Maximum Working Torque ¹		Maximum Torque	Blows Per Minute	Free Speed	Weight		Length		Side To Center		Air Consumption		Socket Retainer Style
	in	in	mm	ft lb	Nm	ft lb	Nm				rpm	lb	kg	in	mm	in	mm	scfm	
IW750MP-6P	3/4	3/4	19	800	1085	1050	1423	1050	6700	7.5	3.44	8.5	215	1.65	42	55	26	Pin	
IW750MP-6PT	3/4	3/4	19	800	1085	1050	1423	1050	6700	7.6	3.5	8.5	215	1.8	46	55	26	Pin	
IW750MP-6H	3/4	3/4	19	800	1085	1050	1423	1050	6700	7.5	3.44	8.5	215	1.65	42	55	26	Hole	
IW750MP-6R	3/4	3/4	19	800	1085	1050	1423	1050	6700	7.5	3.44	8.5	215	1.65	42	55	26	Friction Ring	
IW75BP-6H	3/4	3/4	19	800	1085	1000	1356	1000	5700	11.6	5.3	7.6	193	1.75	45	52	24	Hole	
IW75BP-8H	1	3/4	19	825	1119	1100	1492	1000	5700	11.7	5.3	7.6	193	1.75	45	52	24	Hole	

¹Maximum working torque determined by 5 second rundown on appropriate Skidmore-Wilhelm Torque-Tension Tester.

General: Air Inlet Size: 3/8" NPT • Recommended Hose Size: 1/2" (30 mm) • Performance rated @ 90 psig (6.2 bar) air pressure

Standard Equipment: Parts List • Safety and Instruction Manual • Suspension Bail (IW75BP)

Accessories: Impact Wrench Accessories, see page 41



SAFETY PRECAUTION: Read and follow all safety and operating instructions.
WARNING: Face & eye protection must be worn while operating power tools, per ANSI B186.1

1", 1-1/2" IMPACT WRENCHES



IW1000MP-8H



IW1000MH-8H6



IW1000MH-5S

Performance:

Working Torque: 1,200 ft lb (1630 Nm) – 2,500 ft lb (3390 Nm)

Drive Size: 1" – 1-1/2", #5 Spline

Bolt Capacity: 1-1/4" (32 mm) – 2" (50 mm)

Features:

D-Handle

Inside and Outside Trigger

Steel Anvil Housing

1", 1-1/2" Impact Wrenches



Model Number	Drive Size		Bolt Cap Grade 5		Maximum Working Torque ¹		Maximum Torque		Blows Per Minute	Free Speed	Weight		Length		Side To Center		Air Consumption		Socket Retainer Style
	in		in	mm	ft lb	Nm	ft lb	Nm			rpm	lb	kg	in	mm	in	mm	scfm	
D-Handle – Inside Trigger																			
IW1000MP-8H	1		1-1/4	32	1200	1630	1700	2300	825	6500	18.2	8.3	14.8	376	1.85	47	52	24	Hole/Ring
IW1000MP-8H5	1		1-1/4	32	1200	1630	1700	2300	825	6500	19.7	8.9	19.3	490	1.85	47	52	24	Hole/Ring
IW1000MP-8H8	1		1-1/4	32	1200	1630	1700	2300	825	6500	20.7	9.4	22.3	556	1.85	47	52	24	Hole/Ring
IW1000MH-8H	1		1-1/2	39	2100	2840	2500	3380	800	4000	33.4	15.2	17.0	430	2.5	65	62	29	Hole/Ring
IW1000MH-8H6	1		1-1/2	39	2100	2840	2500	3380	800	4000	37.3	16.9	24.1	610	2.5	65	62	29	Hole/Ring
IW1000MH-5S		#5 Spline	1-1/2	39	2100	2840	2500	3380	800	4000	33.7	15.3	17.6	445	2.5	65	62	29	Hole/Ring
IW150HAI-5S		#5 Spline	2	50	2500	3390	3000	4070	650	3750	33.0	15.0	14.5	368	2.5	65	64	30	Hole
IW150HAI-12H		1-1/2	2	50	2500	3390	3000	4070	650	3750	33.1	15.0	14.5	368	2.5	65	64	30	Hole
D-Handle – Outside Trigger																			
IW150HAO-5S		#5 Spline	2	50	2500	3390	3000	4070	650	3750	33.0	15.0	14.5	368	2.5	65	64	30	Hole
IW150HAO-12H		1-1/2	2	50	2500	3390	3000	4070	650	3750	33.0	15.0	14.5	368	2.5	65	64	30	Hole

¹Maximum working torque determined by 5 second rundown on appropriate Skidmore-Wilhelm Torque-Tension Tester.

General: Air Inlet Size: 1/2" NPT • Recommended Hose Size: 3/4" (19 mm) • Performance rated @ 90 psig (6.2 bar) air pressure

Standard Equipment: Parts List • Safety and Instruction Manual • Support handle (D-Handle models)

Accessories: Impact Wrench Accessories, see page 41

SIOUX SWIVEL

Sioux Swivel

Part Number	Description
1338-25	1/4" non-regulated air swivel connector with safety pin
1338-38	3/8" non-regulated air swivel connector with safety pin
1338-50	1/2" non-regulated air swivel connector with safety pin
1338FC-25	1/4" regulated air swivel connector with safety pin

Allows the air hose to rotate 360° on 2 axes.



1338-25



1338FC-25



SAFETY PRECAUTION: Read and follow all safety and operating instructions.

WARNING: Face & eye protection must be worn while operating power tools, per ANSI B186.1

Clutch Springs



41284
(Green)



41249B



66048
(Silver)



66049
(Blue)



66050
(Green)

Part Number	Color	Torque Range	
		in lb	Nm
SSD6P, SSD10P, 2S Adjustable Clutch			
41284	Green	<25	<2.8
41249B	Plain	>25	>2.8
1 Series Adjustable Clutch & Torque Control			
66048	Silver	30-50	3.4-5.7
66049	Blue	15-35	1.7-4
66050	Green	2-20	0.22-2.3

Tether Plate Kits for Impact Wrenches*



IW500-3



74994A

Part Number	For Use On
IW500-3	IW500MP
74994A	IW750MP

*See Page 35 for Impacts with Pre-Installed Tether

Comfort Grips



66124



68340



66193

Part Number	For Use On (Drills)	For Use On (Screwdrivers)
66124	800 rpm	1 Series inline (800, 1100 & 1500 rpm)
66193	All (except 800 rpm)	1 Series inline (2200 & 2800 rpm)
68340	N/A	SSD4P Series pistol grip

Boots

For use on IW500MP models



IW500MP-BOOT

Support Handles



77067A

Sioux Part Number	Description
77117A	For use on 4P series screwdrivers
77067A	6P, 10P series screwdrivers



SAFETY PRECAUTION: Read and follow all safety and operating instructions.
WARNING: Face & eye protection must be worn while operating power tools, per ANSI B186.1

ABRASIVE



Index

Grinders 44 – 53, 57
Trim Saw 54
Material Removal Tool 55

Cutoff Tools 56 – 57
Abrasive Accessories 58

ABRASIVE

Make Easy Work Out Of A Daily Grind

As manufacturing materials advance, so do the requirements for the tools to work on them. This means new speeds and attachments to handle the demands of increased precision and waste reduction.

The right tool for the job

When selecting a grinder and accessories for your application, be sure to choose one with enough horsepower to drive the abrasive wheel you are using. This will allow the grinder's speed to work for you. When the operator bears down on an under-powered tool, it slows the rpm output and reduces overall efficiency.



Industrial Grinders

Sioux has a great selection of inline and right angle grinders with collet sizes from 1/4" to 1/2" & 3 mm – 8 mm for a variety of applications. Speeds range up to 25,000 rpm to get the job done quickly and efficiently. Some models offer a choice of throttle control that is most convenient and comfortable for the operator. We also have extended models that fit into tight, hard to reach places.

Abrasive Grinders Principles of Operation

When wheels, pads or other accessories are attached to the spindle, the tool can be used to remove metal or composites in a variety of ways.

Abrasive Safety

Grinders can cause flying particles. Proper eye protection must be worn at all times by tools user and bystanders.

Under improper use and wear, Air grinders can cause serious injury and death. The following instructions are important and should be followed explicitly but cannot cover all contingencies. Good judgment is always required.

Using a grinder without a guard can cause injury. The grinder is to be operated with an appropriate guard at all times when a grinding wheel is used. Replace a damaged guard. The guard is to be the proper one for the wheel being used.



Damaged grinding wheels can explode. Check the wheel for damage before mounting, such as chips and cracks. Handle wheels carefully to avoid dropping or bumping. Protect wheels from extremes of temperature and humidity. Check wheels immediately after any unusual occurrence that may damage wheels.

Over speeding wheels can explode. Check the speed rating of the accessory wheels or the speed printed on the wheel. This speed must be greater than the name plate speed of the grinder/sander and the actual speed of the grinder/sander as measured with a tachometer.

Unsecured work can move violently when grinding. Secure work; use clamps or vise to hold work.

Grinders may coast for a short time after the trigger is released. Be sure tool has come to a complete stop before setting it aside.

Grinding wheels that malfunction or spin off can cause injury. Be certain that all wheel, flanges, nuts and related equipment are in good shape, the proper ones for the type and size of wheel being used, and are securely fastened.

Exploding wheels can cause injury or death. If the normal sound of the grinder changes, or if it vibrates excessively, shut it off immediately, remove the wheel, and check speed with tachometer.

Unexpected starts can cause injury. Be sure actuator is off before hooking up air.

Breathing grinding dust can cause injury. Do not breathe grinding dust. Use approved mask.

Explosions and fire can cause injury. Only grind metals if the area is free of combustible or explosive materials or vapors.

Contact with rotating grinding wheels can cause injury. Keep hands and other body parts away from grinding wheels and sanding pads and disks to prevent cutting or pinching. Wear protective clothing and gloves to protect hands.

Tools starting unexpectedly can cause injury. Always remove tool from air supply and activate trigger to bleed air line before making any adjustments, changing accessories, or doing any maintenance or service on the tool.

Flying grinding wheels or accessories can cause injury. Tighten collet securely. Match wheel or accessory shaft diameter to chuck or collet.

Exploding or flying parts can cause injury. Do not use cut off wheels or router bits with die grinders.



STRAIGHT DIE GRINDERS



SDG03S25



SDG05S23



SDG7S25F



SDG10S25F

Performance:

Power: 0.3 hp (0.2 kW) – 1 hp (0.75 kW)
 Speed: 12,000 rpm – 25,000 rpm
 Collet Size: 1/4" & 6 mm

Features:

Lockoff Lever
 Front or Rear Exhaust
 Built-in Speed Control

Straight Die Grinders



Model Number	Free Speed	Weight		Length		Air Consumption		Collet Size	Exhaust
	rpm	lb	kg	in	mm	scfm	l/s		
0.3 hp (0.22 kW) – Lever Throttle – 200 Series Collet									
SDG03S25	25000	1.0	0.45	6.25	160	11	5.2	1/4"	Rear
SDG03S25M6	25000	1.0	0.45	6.25	160	11	5.2	6 mm	Rear
0.3 hp (0.22 kW) – Lever Throttle – 300 Series Collet									
SDG03S25S	25000	1.0	0.45	6.25	160	11	5.2	1/4"	Rear
SDG03S25M6S	25000	1.0	0.45	6.25	160	11	5.2	6mm	Rear
0.5 hp (0.37 kW) – Lever Throttle – 200 Series Collet									
SDG05S18	18000	1.2	0.54	7.0	180	23	10.9	1/4"	Rear
SDG05S18M6	18000	1.2	0.54	7.0	180	23	10.9	6 mm	Rear
SDG05S23	23000	1.2	0.54	7.0	180	23	10.9	1/4"	Rear
SDG05S23M6	23000	1.2	0.54	7.0	180	23	10.9	6 mm	Rear
0.5 hp (0.37 kW) – Lever Throttle – 300 Series Collet									
SDG05S18S	18000	1.2	0.54	7.0	180	23	10.9	1/4"	Rear
SDG05S18M6S	18000	1.2	0.54	7.0	180	23	10.9	6mm	Rear
SDG05S23S	23000	1.2	0.54	7.0	180	23	10.9	1/4"	Rear
SDG05S23M6S	23000	1.2	0.54	7.0	180	23	10.9	6mm	Rear
0.7 hp (0.52 kW) – Lever Throttle – 200 Series Collet									
SDG7S18F	18000	1.2	0.6	6.0	150	25	12	1/4"	Front
SDG7S18M6F	18000	1.2	0.6	6.0	150	25	12	6 mm	Front
SDG7S25F	25000	1.2	0.6	6.0	150	25	12	1/4"	Front
SDG7S25M6F	25000	1.2	0.6	6.0	150	25	12	6 mm	Front
0.7 hp (0.52 kW) – Lever Throttle – 300 Series Collet									
SDG7S18FS	18000	1.2	0.6	6.0	150	25	12	1/4"	Front
SDG7S25FS	25000	1.2	0.6	6.0	150	25	12	1/4"	Front
1 hp (0.75 kW) – Lever Throttle – 200 Series Collet									
SDG10S12F	12000	1.7	0.8	7.5	190	30	14	1/4"	Front
SDG10S12M6F	12000	1.7	0.8	7.5	190	30	14	6 mm	Front
SDG10S12R	12000	1.7	0.8	7.5	190	30	14	1/4"	Rear
SDG10S12M6R	12000	1.7	0.8	7.5	190	30	14	6 mm	Rear
SDG10S18F	18000	1.7	0.8	7.5	190	30	14	1/4"	Front
SDG10S18M6F	18000	1.7	0.8	7.5	190	30	14	6 mm	Front
SDG10S18R	18000	1.7	0.8	7.5	190	30	14	1/4"	Rear
SDG10S18M6R	18000	1.7	0.8	7.5	190	30	14	6 mm	Rear
SDG10S25F	25000	1.7	0.8	7.5	190	30	14	1/4"	Front
SDG10S25M6F	25000	1.7	0.8	7.5	190	30	14	6 mm	Front
SDG10S25R	25000	1.7	0.8	7.5	190	30	14	1/4"	Rear
SDG10S25M6R	25000	1.7	0.8	7.5	190	30	14	6 mm	Rear

General: Air Inlet Size: 1/4" NPT • Recommended Hose Size: 3/8" (10 mm) • Performance rated @ 90 psig (6.2 bar) air pressure

Standard Equipment: Parts List • Safety and Instruction Manual • Collet & Wrenches • Collet Guard (1DS series)

Accessories: Grinder Accessories, see page 58



SAFETY PRECAUTION: Read and follow all safety and operating instructions.
WARNING: Face & eye protection must be worn while operating power tools, per ANSI B186.1

STRAIGHT DIE GRINDERS



SDGS1S18



SDGS1S18G

Performance:

Power: 1 hp (0.75 kW)
 Speed: 12,000 rpm – 25,000 rpm
 Collet Size: 1/4" & 6 mm

Features:

Lockoff Lever
 Front Exhaust
 Built-in Speed Control

Straight Metal Body Die Grinders



Model Number	Free Speed	Weight		Length		Air Consumption		Collet Size	Exhaust
	rpm	lb	kg	in	mm	scfm	l/s		
1 hp (0.75 kW) – Lever Throttle – Aluminum Housing									
SDGA1S12	12000	1.5	0.7	6.9	175	30	14	1/4"	Front
SDGA1S12M6	12000	1.5	0.7	6.9	175	30	14	6 mm	Front
SDGA1S18	18000	1.5	0.7	6.9	175	30	14	1/4"	Front
SDGA1S18M6	18000	1.5	0.7	6.9	175	30	14	6 mm	Front
SDGA1S25	25000	1.5	0.7	6.9	175	30	14	1/4"	Front
SDGA1S25M6	25000	1.5	0.7	6.9	175	30	14	6 mm	Front
1 hp (0.75 kW) – Lever Throttle – Aluminum Housing with Grip									
SDGA1S12G	12000	1.4	0.6	6.9	175	30	14	1/4"	Front
SDGA1S12M6G	12000	1.4	0.6	6.9	175	30	14	6 mm	Front
SDGA1S18G	18000	1.4	0.6	6.9	175	30	14	1/4"	Front
SDGA1S18M6G	18000	1.4	0.6	6.9	175	30	14	6 mm	Front
SDGA1S25G	25000	1.4	0.6	6.9	175	30	14	1/4"	Front
SDGA1S25M6G	25000	1.4	0.6	6.9	175	30	14	6 mm	Front
1 hp (0.75 kW) – Lever Throttle – Steel Housing									
SDGS1S12	12000	2.2	1.0	6.9	175	30	14	1/4"	Front
SDGS1S12M6	12000	2.2	1.0	6.9	175	30	14	6 mm	Front
SDGS1S18	18000	2.2	1.0	6.9	175	30	14	1/4"	Front
SDGS1S18M6	18000	2.2	1.0	6.9	175	30	14	6 mm	Front
SDGS1S25	25000	2.2	1.0	6.9	175	30	14	1/4"	Front
SDGS1S25M6	25000	2.2	1.0	6.9	175	30	14	6 mm	Front
1 hp (0.75 kW) – Lever Throttle – Steel Housing with Grip									
SDGS1S12G	12000	1.8	0.8	6.9	175	30	14	1/4"	Front
SDGS1S12M6G	12000	1.8	0.8	6.9	175	30	14	6 mm	Front
SDGS1S18G	18000	1.8	0.8	6.9	175	30	14	1/4"	Front
SDGS1S18M6G	18000	1.8	0.8	6.9	175	30	14	6 mm	Front
SDGS1S25G	25000	1.8	0.8	6.9	175	30	14	1/4"	Front
SDGS1S25M6G	25000	1.8	0.8	6.9	175	30	14	6 mm	Front

General:

Air Inlet Size: 1/4" NPT • Recommended Hose Size: 3/8" (10 mm) • Performance rated @ 90 psig (6.2 bar) air pressure

Standard Equipment:

Parts List • Safety and Instruction Manual • Collet & Wrenches

Accessories:

Grinder Accessories, see page 58



SAFETY PRECAUTION: Read and follow all safety and operating instructions.
WARNING: Face & eye protection must be worn while operating power tools, per ANSI B186.1

EXTENDED DIE GRINDERS

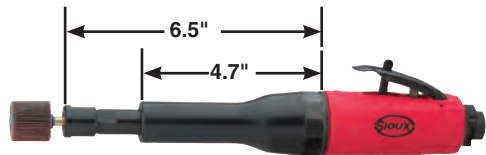

SXG05S23

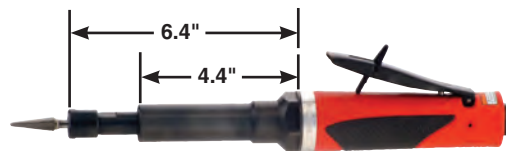

STXG10S23

Performance:

Power: 0.5 hp (0.37 kW) – 1 hp (0.75 kW)
 Speed: 12,000 rpm – 23,000 rpm
 Collet Size: 1/4" (6 mm)

Features:

Heavy duty double tapered collet
 Ergonomic comfort grip
 Teasing throttle for maximum control
 Lever throttle with lock-off
 Ball bearing construction
 Adjustable speed control

Extended Die Grinders



Model Number	Free Speed	Weight		Length		Air Consumption		Collet Size	Exhaust
	rpm	lb	kg	in	mm	scfm	l/s		
0.5 hp (0.37 kW) – Lever Throttle – Extended – 200 Series Collet									
SXG05S18	18000	2.1	0.95	11.0	280	23	10.9	1/4"	Rear
SXG05S18M6	18000	2.1	0.95	11.0	280	23	10.9	6 mm	Rear
SXG05S23	23000	2.1	0.95	11.0	280	23	10.9	1/4"	Rear
SXG05S23M6	23000	2.1	0.95	11.0	280	23	10.9	6 mm	Rear
0.5 hp (0.37 kW) – Extended Die Grinder Lever Throttle – 300 Series Collet									
SXG05S18S	18000	2.1	0.95	11.0	280	23	10.9	1/4"	Rear
SXG05S18M6S	18000	2.1	0.95	11.0	280	23	10.9	6mm	Rear
SXG05S23S	23000	2.1	0.95	11.0	280	23	10.9	1/4"	Rear
SXG05S23M6S	23000	2.1	0.95	11.0	280	23	10.9	6mm	Rear
1 hp (0.75 kW) – Lever Throttle – Extended – 200 Series Collet									
STXG10S12	12000	2.2	1.0	12.1	308	30	14	1/4"	Rear
STXG10S12M6	12000	2.2	1.0	12.1	308	30	14	6 mm	Rear
STXG10S18	18000	2.2	1.0	12.1	308	30	14	1/4"	Rear
STXG10S18M6	18000	2.2	1.0	12.1	308	30	14	6 mm	Rear
STXG10S23	23000	2.2	1.0	12.1	308	30	14	1/4"	Rear
STXG10S23M6	23000	2.2	1.0	12.1	308	30	14	6 mm	Rear
1 hp (0.75 kW) – Lever Throttle – Extended – Cone Wheel									
STXG10S18CW	18000	2.2	1.0	12.2	310	30	14	3/8"-24 EXT Thread	Rear

General:

Air Inlet Size: 1/4" NPT • Recommended Hose Size: 3/8" (10 mm) • Performance rated @ 90 psig (6.2 bar) air pressure

Standard Equipment:

Parts List • Safety and Instruction Manual • Collet & Wrenches

Accessories:

Grinder Accessories, see page 58



SAFETY PRECAUTION: Read and follow all safety and operating instructions.
WARNING: Face & eye protection must be worn while operating power tools, per ANSI B186.1

HIGH TORQUE DIE GRINDERS

Double Ball Bearing Support On Output Spindle

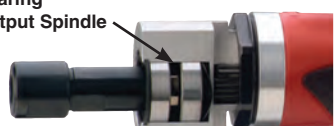

Offset Gear Box For Increased Torque



SDG10SHT08



SDG10SHT12

High Torque Die Grinders



Model Number	Free Speed	Weight		Length		Air Consumption		Collet Size	Exhaust
	rpm	lb	kg	in	mm	scfm	l/s		
1 hp (0.75 kW) – Lever Throttle – High Torque									
SDG10SHT08	8000	2.0	0.90	9.5	240	35	16.5	1/4"	Rear
SDG10SHT08M6	8000	2.0	0.90	9.5	240	35	16.5	6 mm	Rear
SDG10SHT12	12000	2.0	0.90	9.5	240	35	16.5	1/4"	Rear
SDG10SHT12M6	12000	2.0	0.90	9.5	240	35	16.5	6 mm	Rear

General:

Air Inlet Size: 1/4" NPT • Recommended Hose Size: 3/8" (10 mm) • Performance rated @ 90 psig (6.2 bar) air pressure

Standard Equipment:

Parts List • Safety and Instruction Manual • Collet & Wrenches

Accessories:

Grinder Accessories, see page 58

STRAIGHT DIE GRINDERS



RT1985

Performance:

Power: 1.5 hp (1.1 kW)
 Speed: 20,000 rpm
 Collet Size: 1/4" – 1/2" & 6 mm

Features:

Twist Throttle
 Side Exhaust
 Built-in Speed Control

Straight Die Grinders



Model Number	Free Speed	Weight		Length		Air Consumption		Collet Size	Exhaust
	rpm	lb	kg	in	mm	scfm	l/s		
1.5 hp (1.1 kW) – Twist Throttle									
RT1985 ¹	20000	4.3	2.0	7.6	193	38	18	1/4"	Side
1985-1/2	20000	4.3	2.0	7.6	193	38	18	1/2"	Side
1985A	20000	4.3	2.0	7.6	193	38	18	3/8"	Side

¹Not CE Certified

General:

Air Inlet Size: 1/4" NPT • Recommended Hose Size: 3/8" (10 mm) • Performance rated @ 90 psig (6.2 bar) air pressure

Standard Equipment:

Parts List • Safety and Instruction Manual • Collet & Wrenches • Collet Guard (1DS series)

Accessories:

Grinder Accessories, see page 58



SAFETY PRECAUTION: Read and follow all safety and operating instructions.
WARNING: Face & eye protection must be worn while operating power tools, per ANSI B186.1

RIGHT ANGLE DIE GRINDERS

Performance:

Power: 0.3 hp (0.22 kW) – 1 hp (0.75 kW)
 Speed: 3,300 rpm – 23,000 rpm
 Collet Size: 1/4" & 6 mm

Features:

Spiral Bevel Gears
 Steel Angle Head
 Built-in Speed Control

Right Angle Die Grinders



Model Number	Free Speed	Weight		Length		Air Consumption		Collet Size	Exhaust
	rpm	lb	kg	in	mm	scfm	l/s		
0.3 hp (0.22 kW) – Lever Throttle – 200 Series Collet									
SAG03S12	12000	1.4	0.6	5.6	140	11	5.2	1/4"	Rear
SAG03S12M6	12000	1.4	0.6	5.6	140	11	5.2	6 mm	Rear
SAG03S20	20000	1.4	0.6	5.6	140	11	5.2	1/4"	Rear
SAG03S20M6	20000	1.4	0.6	5.6	140	11	5.2	6 mm	Rear
0.3 hp (0.22 kW) – Lever Throttle – 300 Series Collet									
SAG03S12S	12000	1.35	0.45	5.6	143	11	5.2	1/4"	Rear
SAG03S12M6S	12000	1.35	0.45	5.6	143	11	5.2	6mm	Rear
SAG03S20S	20000	1.35	0.45	5.6	143	11	5.2	1/4"	Rear
SAG03S20M6S	20000	1.35	0.45	5.6	143	11	5.2	6mm	Rear
0.5 hp (0.37 kW) – Lever Throttle – 200 Series Collet									
SAG05S33	3300	2.2	1.0	8.2	208	23	11	1/4"	Rear
SAG05S54	5400	2.2	1.0	8.2	208	23	11	1/4"	Rear
SAG05S12	12000	1.7	0.77	6.9	175	23	11	1/4"	Rear
SAG05S12M6	12000	1.7	0.77	6.9	175	23	11	6 mm	Rear
SAG05S15	15000	1.7	0.77	6.9	175	23	11	1/4"	Rear
SAG05S15M6	15000	1.7	0.77	6.9	175	23	11	6mm	Rear
SAG05S18	18000	1.7	0.77	6.9	175	23	11	1/4"	Rear
SAG05S18M6	18000	1.7	0.77	6.9	175	23	11	6mm	Rear
SAG05S23	23000	1.6	0.64	6.4	160	23	10.8	1/4"	Rear
SAG05S23M6	23000	1.6	0.64	6.4	160	23	10.8	6 mm	Rear
0.5 hp (0.37 kW) – Lever Throttle – 300 Series Collet									
SAG05S12S	12000	1.65	0.77	6.9	175	23	11	1/4"	Rear
SAG05S12M6S	12000	1.65	0.77	6.9	175	23	11	6 mm	Rear
SAG05S15S	15000	1.65	0.77	6.9	175	23	11	1/4"	Rear
SAG05S15M6S	15000	1.65	0.77	6.9	175	23	11	6mm	Rear
SAG05S18S	18000	1.65	0.77	6.9	175	23	11	1/4"	Rear
SAG05S18M6S	18000	1.65	0.77	6.9	175	23	11	6mm	Rear
SAG05S23S	23000	1.55	0.61	6.4	162	23	10.8	1/4"	Rear
SAG05S23M6S	23000	1.55	0.61	6.4	162	23	10.8	6mm	Rear
0.70 hp (0.52 kW) – Lever Throttle – 200 Series Collet									
SAG7S12	12000	2.0	0.90	6.5	165	25	12	1/4"	Front
SAG7S12M6	12000	2.0	0.90	6.5	165	25	12	6mm	Front
SAG7S15	15000	2.0	0.90	6.5	165	25	12	1/4"	Front
SAG7S15M6	15000	2.0	0.90	6.5	165	25	12	6mm	Front
SAG7S18	18000	2.0	0.90	6.5	165	25	12	1/4"	Front
SAG7S18M6	18000	2.0	0.90	6.5	165	25	12	6mm	Front
1 hp (0.75 kW) – Lever Throttle – 200 Series Collet									
SAG10S12	12000	2.7	1.2	9.0	230	30	14	1/4"	Rear
SAG10S12M6	12000	2.7	1.2	9.0	230	30	14	6 mm	Rear
SAG10S15	15000	2.7	1.2	9.0	230	30	14	1/4"	Rear
SAG10S15M6	15000	2.7	1.2	9.0	230	30	14	6 mm	Rear
SAG10S18	18000	2.7	1.2	9.0	230	30	14	1/4"	Rear
SAG10S18M6	18000	2.7	1.2	9.0	230	30	14	6 mm	Rear

General: Air Inlet Size: 1/4" NPT • Recommended Hose Size: 3/8" (10 mm) • Performance rated @ 90 psig (6.2 bar) air pressure
Standard Equipment: Parts List • Safety and Instruction Manual • Collet, Support Handle (1 HP only) & Wrenches
Accessories: Grinder Accessories, see page 58

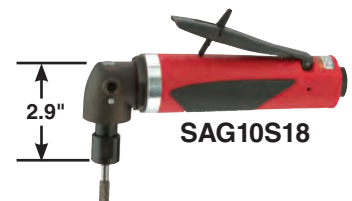

SAFETY PRECAUTION: Read and follow all safety and operating instructions.

WARNING: Face & eye protection must be worn while operating power tools, per ANSI B186.1

RIGHT ANGLE EXTENDED DIE GRINDERS



Performance:

Power: 0.7 hp (0.52 kW) – 1 hp (0.75 kW)
 Speed: 12,000 rpm – 20,000 rpm
 Collet Size: 1/4" & 6 mm

Features:

Steel Angle Head
 Spiral Bevel Gears
 200 Series Collet
 Built-in Speed Control

Right Angle Extended Die Grinders



Model Number	Free Speed	Weight		Length		Air Consumption		Collet Size	Exhaust
	rpm	lb	kg	in	mm	scfm	l/s		
0.7 hp (0.52 kW) – Aluminum Housing									
SAG7AX13	13000	2.9	1.3	10.0	254	25	12	1/4"	Front
SAG7AX13M6	13000	2.9	1.3	10.0	254	25	12	6 mm	Front
SAG7AX16	16000	2.9	1.3	10.0	254	25	12	1/4"	Front
SAG7AX16M6	16000	2.9	1.3	10.0	254	25	12	6 mm	Front
SAG7AX20	20000	2.9	1.3	10.0	254	25	12	1/4"	Front
SAG7AX20M6	20000	2.9	1.3	10.0	254	25	12	6 mm	Front
1 hp (0.75 kW) – Composite Comfort Housing									
SAG10AX12	12000	3.20	1.45	11.25	286	30	14.2	1/4"	Rear
SAG10AX12M6	12000	3.20	1.45	11.25	286	30	14.2	6mm	Rear
SAG10AX15	15000	3.20	1.45	11.25	286	30	14.2	1/4"	Rear
SAG10AX15M6	15000	3.20	1.45	11.25	286	30	14.2	6mm	Rear
SAG10AX18	18000	3.20	1.45	11.25	286	30	14.2	1/4"	Rear
SAG10AX18M6	18000	3.20	1.45	11.25	286	30	14.2	6mm	Rear
1 hp (0.75 kW) – Aluminum Housing									
SAGA1AX12	12000	3.2	1.5	10.5	267	30	14.2	1/4"	Front
SAGA1AX12M6	12000	3.2	1.5	10.5	267	30	14.2	6mm	Front
SAGA1AX18	18000	3.2	1.5	10.5	267	30	14.2	1/4"	Front
SAGA1AX18M6	18000	3.2	1.5	10.5	267	30	14.2	6mm	Front
1 hp (0.75 kW) – Aluminum Housing with Grip									
SAGA1AX12G	12000	2.9	1.3	10.5	267	30	14.2	1/4"	Front
SAGA1AX12M6G	12000	2.9	1.3	10.5	267	30	14.2	6mm	Front
SAGA1AX18G	18000	2.9	1.3	10.5	267	30	14.2	1/4"	Front
SAGA1AX18M6G	18000	2.9	1.3	10.5	267	30	14.2	6mm	Front

General: Air Inlet Size: 1/4" NPT • Recommended Hose Size: 3/8" (10 mm) • Performance rated @ 90 psig (6.2 bar) air pressure

Standard Equipment: Parts List • Safety and Instruction Manual • Collet • Support Handle • Wrenches

Accessories: Grinder Accessories, see page 58



SAFETY PRECAUTION: Read and follow all safety and operating instructions.
WARNING: Face & eye protection must be worn while operating power tools, per ANSI B186.1

RIGHT ANGLE TYPE 27 WHEEL GRINDERS



Performance:

Power: 0.5 hp (0.37 kW) – 1 hp (0.75 kW)
 Speed: 12,000 rpm – 18,000 rpm
 Wheel Capacity: 3" (75 mm) –
 6" (150 mm) diameter

Features:

Non-Governed
 Lockoff Lever Throttle
 Rear Exhaust



Right Angle Type 27 Wheel Grinders



Model Number	Free Speed	Wheel Capacity		Weight		Length		Air Consumption		Spindle Thread
	rpm	in	mm	lb	kg	in	mm	scfm	l/s	
0.5 hp (0.37 kW)										
SWG05S183	18000	3.0	75	2.0	0.91	7.0	178	23	11	3/8"-24
0.7 hp (0.52 kW)										
SWG7S183	18000	3.0	75	2.1	0.95	6.4	163	25	12	3/8"-24
1 hp (0.75 kW) – Medium Duty Angle Head										
SWG10A124	12000	4.0	100	2.5	1.1	7.75	195	35	17	3/8" - 24
SWG10A1245	12000	4.5	115	2.6	1.17	7.75	195	35	17	5/8"-11
SWG10A125	12000	5.0	125	2.7	1.22	7.75	195	35	17	5/8" - 11
SWG10S183	18000	3.0	75	2.5	1.1	7.5	190	35	17	3/8"-24
1 hp (0.75 kW) – Heavy Duty Angle Head										
SWG10S124	12000	4.0	100	3.3	1.5	8.3	210	35	17	3/8"-24
SWG10S1245	12000	4.5	115	3.3	1.5	8.3	210	35	17	5/8"-11
SWG10S125	12000	5.0	125	3.4	1.5	8.3	210	35	17	5/8"-11
SWG10S106	10000	6.0	150	3.7	1.7	8.3	210	35	17	5/8"-11

General: Air Inlet Size: 1/4" NPT • Recommended Hose Size: 3/8" (10 mm) • Performance rated @ 90 psig (6.2 bar) air pressure

Standard Equipment: Parts List • Safety and Instruction Manual • Spindle Wrenches • Wheel Guard • Support Handle • Mounting Flange & Nut

Accessories: Grinder Accessories, see page 58



SAFETY PRECAUTION: Read and follow all safety and operating instructions.

WARNING: Face & eye protection must be worn while operating power tools, per ANSI B186.1

EXTENDED TYPE 27 WHEEL GRINDERS



Performance:

Power: 0.7 hp (0.52 kW) – 1 hp (0.75 kW)
 Speed: 12,000 rpm – 20,000 rpm
 Wheel Capacity: 3" (75 mm) – 5" (127 mm)

Features:

Non-Governed
 Lockoff Lever
 Adjustable Guard

Right Angle Type 27 Extended Wheel Grinders



Model Number	Free Speed	Wheel Capacity		Weight		Length		Air Consumption		Spindle Thread	Exhaust
	rpm	In	mm	lb	kg	in	mm	scfm	l/s		
0.7 hp (0.52 kW) – Aluminum Housing											
SWG7AX134	13300	4.0	100	3.5	1.6	10.0	254	25	12	3/8" - 24	Front
SWG7AX1345	13300	4.5	115	3.5	1.6	10.0	254	25	12	5/8" - 11	Front
SWG7AX203	20000	3.0	75	3.5	1.6	10.0	254	25	12	3/8" - 24	Front
1 hp (0.75 kW) – Comfort Grip											
SWG10AX124	12000	4.0	100	3.6	1.63	11.25	285	35	17	3/8" - 24	Rear
SWG10AXL124	12000	4.0	100	3.5	1.59	11.25	285	35	17	3/8" - 24	Rear
SWG10AX1245	12000	4.5	115	3.7	1.68	11.25	285	35	17	5/8" - 11	Rear
SWG10AX125	12000	5.0	125	3.8	1.72	11.25	285	35	17	5/8" - 11	Rear
1 hp (0.75 kW) – Heavy Duty Angle Head – Comfort Grip											
SWG10SX124	12000	4.0	100	4.2	1.9	11.7	300	35	17	3/8"-24	Rear
SWG10SX1245	12000	4.5	115	4.3	2.0	11.7	300	35	17	5/8"-11	Rear
SWG10SX125	12000	5.0	125	4.3	2.0	11.7	300	35	17	5/8"-11	Rear
1 hp (0.75 kW) – Aluminum Housing											
SWG1AX124	12000	4.0	100	3.3	1.5	10.5	267	35	17	3/8" - 24	Front
SWG1AX1245	12000	4.5	115	3.4	1.5	10.5	267	35	17	5/8" - 11	Front
1 hp (0.75 kW) – Aluminum Housing with Grip											
SWG1AX124G	12000	4.0	100	3.2	1.5	10.5	267	35	17	3/8" - 24	Front
SWG1AX1245G	12000	4.5	115	3.3	1.5	10.5	267	35	17	5/8" - 11	Front
1 hp (0.75 kW) – Steel Housing											
SWGS1AX124	12000	4.0	100	3.9	1.8	10.5	267	35	17	3/8" - 24	Front
SWGS1AX1245	12000	4.5	115	4.0	1.8	10.5	267	35	17	5/8" - 11	Front
1 hp (0.75 kW) – Steel Housing with Grip											
SWGS1AX124G	12000	4.0	100	3.7	1.7	10.5	267	35	17	3/8" - 24	Front
SWGS1AX1245G	12000	4.5	115	3.8	1.7	10.5	267	35	17	5/8" - 11	Front

General: 0.7 hp models: Air Inlet Size: 1/4" NPT • Recommended Hose Size: 3/8" (10 mm) • Performance rated @ 90 psig (6.2 bar) air pressure

1 hp models: Air Inlet Size: 3/8" NPT • Recommended Hose Size: 3/8" (10 mm) • Performance rated @ 90 psig (6.2 bar) air pressure

Standard Equipment: Parts List • Safety and Instruction Manual • Spindle Wrenches • Wheel Guard • Support Handle • Mounting Flange & Nut • Grinding Wheel

Accessories: Grinder Accessories, see page 58



SAFETY PRECAUTION: Read and follow all safety and operating instructions.
WARNING: Face & eye protection must be worn while operating power tools, per ANSI B186.1

RIGHT ANGLE TYPE 27 WHEEL GRINDERS



Performance:

Power: 1.2 hp (0.9 kW) – 2.2 hp (1.6 kW)
 Speed: 6,000 rpm – 12,000 rpm
 Wheel Capacity: 4.5" (115 mm) – 7" (175 mm) diameter

Features:

Governed
 Lockoff Lever Throttle
 Side Exhaust

Right Angle Type 27 Wheel Grinders



Model Number	Free Speed		Wheel Capacity		Weight		Length		Air Consumption Under Load		Air Consumption Free Speed		Spindle Thread
	rpm		in	mm	lb	kg	in	mm	scfm	l/s	scfm	l/s	
1.2 hp (0.9 kW) – Governed Speed													
1285L ¹	6000		7.0	180	6.8	3.1	12.4	315	43	20	22	10	5/8"-11
1.6 hp (1.2 kW) – Governed Speed													
AG16D1245	12000		4.5	115	4.3	1.9	11.0	280	53	25	40	19	5/8"-11
AG16D125	12000		5.0	125	4.4	2.0	11.0	280	53	25	40	19	5/8"-11
AG16D106	10000		6.0	150	4.6	2.1	11.0	280	53	25	40	19	5/8"-11
2.2 hp (1.6 kW) – Governed Speed													
AG22D847	8400		7.0	175	6.1	2.8	12.4	315	60	28	45	21	5/8"-11

¹Not CE Certified

General: Air Inlet Size: 1/4" NPT (1285L); 3/8" NPT (AG) • Recommended Hose Size: 3/8" (10 mm) (1285L); 1/2" (13mm) (AG)

Performance rated @ 90 psig (6.2 bar) air pressure

Standard Equipment: Parts List • Safety and Instruction Manual • Spindle Wrenches • Wheel Guard • Support Handle • Mounting Flange & Nut

Accessories: Grinder Accessories, see page 58



SAFETY PRECAUTION: Read and follow all safety and operating instructions.

WARNING: Face & eye protection must be worn while operating power tools, per ANSI B186.1

VERTICAL WHEEL GRINDERS



1291



VG40D609



VG40D807



VG40C606



VG50D807



VG50D609



VG50C606

Performance:

Power: 1.2 hp (0.9 kW) – 5 hp (3.7 kW)
 Speed: 5,000 rpm – 8,000
 Diameter: 6" (150 mm) – 9" (230 mm)

Features:

Governed & Non-Governed
 Lockoff Lever & Thumb Throttle
 Side Exhaust
 5/8"-11 Spindle Thread
 2-Stage Throttle (VG Series)

Vertical Wheel Grinders



Model Number	Free Speed	Pad Diameter		Weight		Height		Air Consumption Under Load		Air Consumption Free Speed	
	rpm	in	mm	lb	kg	in	mm	scfm	l/s	scfm	l/s
1.2 hp (0.9 kW) – Type 27 – Non-Governed Speed – Thumb Throttle											
1291	5000	7.0	175	5.0	2.3	7.2	183	N/A	N/A	38	18
1.2 hp (0.9 kW) – Type 27 – Non-Governed Speed – Lever Throttle											
1291L	6000	7.0	175	5.0	2.3	7.2	183	N/A	N/A	38	18
4 hp (2.9 kW) – Type 27 – Governed Speed											
VG40D607	6000	7.0	175	9.4	4.3	7.7	195	70	33	40	19
VG40D807	8000	7.0	175	9.4	4.3	7.7	195	70	33	40	19
VG40D609	6000	9.0	230	10.4	4.7	7.7	195	70	33	40	19
5 hp (3.7 kW) – Type 27 – Governed Speed											
VG50D607	6000	7.0	175	11.2	5.1	8.4	215	96	45	55	26
VG50D807	8000	7.0	175	11.2	5.1	8.4	215	96	45	55	26
VG50D609	6000	9.0	230	12.2	5.5	8.4	215	96	45	55	26
4 hp (2.9 kW) – Type 6 & 11 – Governed Speed											
VG40C606	6000	6.0	150	10.5	4.8	8.0	205	70	33	40	19
5 hp (3.7 kW) – Type 6 & 11 – Governed Speed											
VG50C606	6000	6.0	150	12.3	5.6	8.7	220	96	45	55	26

General: Air Inlet Size: 1/2" NPT • Recommended Hose Size: 3/8" (10 mm) (1291, 1291L); 3/4" (19 mm) (VG Series) • Performance rated @ 90 psig (6.2 bar) air pressure
Standard Equipment: Parts List • Safety and Instruction Manual • Spindle Wrenches • Wheel Guard • Mounting Flange & Nut • Grinding Wheel (1291, 1291L)
Accessories: Grinder Accessories, see page 58



SAFETY PRECAUTION: Read and follow all safety and operating instructions.
WARNING: Face & eye protection must be worn while operating power tools, per ANSI B186.1



FIBERGLASS TRIM SAW



STS10A124



Performance:

Speed: 12,000 rpm
Wheel Capacity: 4" (100 mm)

Features:

1" Cut Depth
Rotatable Guard
Vacuum Ready
Cut Guide

4" Fiberglass Trim Saw

Model Number	Wheel Capacity		Free Speed	Weight		Length		Air Consumption		Spindle Thread	Exhaust
	in	mm	rpm	lb	kg	in	mm	scfm	l/s		
STS10A124	4	100	12000	3.25	1.5	9.5	240	35	17	3/8"-24	Rear

General: Air Inlet Size: 1/4" NPT • Recommended Hose Size: 3/8" (10 mm) • Performance rated @ 90 psig (6.2 bar) air pressure

Standard Equipment: Parts List • Safety and Instruction Manual • 4" Diamond-Coated Blades Sold Separately

Accessories: Material Removal Tool Accessories, see page 58

DIAMOND BLADE

2311



Part Number	Description
2311	4" Continuous-Rim Diamond Blade with 3/8" arbor hole



SAFETY PRECAUTION: Read and follow all safety and operating instructions.
WARNING: Face & eye protection must be worn while operating power tools, per ANSI B186.1

MATERIAL REMOVAL TOOL



SMR05S354



Performance:

Power: 0.5 hp (0.37 kW)
Speed: 3,500 rpm

Features:

Removable Support Handle
Lockoff Lever
Planetary Gear for Increased Torque

Material Removal Tool

Model Number	Free Speed	Weight		Length		Air Consumption		Exhaust
	rpm	lb	kg	in	mm	scfm	l/s	
SMR05S354	3500	2.4	1.08	12.0	304.8	28	132	Rear

General: Air Inlet Size: 1/4" NPT • Recommended Hose Size: 3/8" (10 mm) • Performance rated @ 90 psig (6.2 bar) air pressure
Standard Equipment: Parts List • Safety and Instruction Manual • Fine Belt (68813) • Coarse Belt (68814) • Eraser (68815) • Support Handle
Accessories: Panel and Cutoff Saw Accessories, see page 58



Hub Set SPPT280-300



Eraser 68815



Course Wire Belt 68814



Fine Wire Belt 68813



Medium Stainless Steel Wire Belt 68917



Fine Stainless Steel Wire Belt 68915

BELTS AND ERASERS

Part Number	Description
SPPT280-300	11mm Hub Set
68815	Rubber Eraser
68814	Course Wire Belt, 23 mm Wide
68910	Course Wire Belt, 11 mm Wide
68911	Medium Wire Belt, 23 mm Wide
68912	Medium Wire Belt, 11 mm Wide
68813	Fine Wire Belt, 23 mm Wide
68913	Fine Wire Belt, 11 mm Wide
68916	Medium Stainless Steel Wire Belt, 23 mm Wide
68917	Medium Stainless Steel Wire Belt, 11 mm Wide
68914	Fine Stainless Steel Wire Belt, 23 mm Wide
68915	Fine Stainless Steel Wire Belt, 11 mm Wide



SAFETY PRECAUTION: Read and follow all safety and operating instructions.
WARNING: Face & eye protection must be worn while operating power tools, per ANSI B186.1

CUTOFF TOOLS (TYPE 1)

Performance:

Power: 1 hp (0.75 kW)
Free Speed: 18,000 rpm – 25,000 rpm

Features:

Inline
Lockoff Lever Start
Front or Rear Exhaust



SCO10S253F



Cutoff Tool

Model Number	Blade Diameter		Depth of Cut		Free Speed rpm	Weight		Length		Air Consumption		Exhaust
	in	mm	in	mm		lb	kg	in	mm	scfm	l/s	
1 hp (0.75 kW) – Cutoff Tool – Inline – Lockoff lever Start												
SCO10S184F	4.0	100	1.1	28	18000	2.0	0.9	8.3	210	30	14	Front
SCO10S184R	4.0	100	1.1	28	18000	2.0	0.9	8.3	210	30	14	Rear
SCO10S204F	4.0	100	1.1	28	20000	2.0	0.9	8.3	210	30	14	Front
SCO10S204R	4.0	100	1.1	28	20000	2.0	0.9	8.3	210	30	14	Rear
SCO10S253F	3.0	76	1.0	25	25000	2.0	0.9	8.3	210	30	14	Front
SCO10S253R	3.0	76	1.0	25	25000	2.0	0.9	8.3	210	30	14	Rear

General: Air Inlet Size: 1/4" NPT • Recommended Hose Size: 3/8" (10 mm) • Performance rated @ 90 psig (6.2 bar) air pressure

Standard Equipment: Parts List • Safety and Instruction Manual • 1 Blade • Spindle Wrenches & Guard

Accessories: Cutoff Saw Accessories, see page 58

ANGLE CUTOFF TOOLS (TYPE 1)

Features:

Heavy duty spiral bevel gearing for durability and smooth operation
4 position indexable angle head
360 degree rotatable guard



SCO10A106



Angle Cutoff Tool

Model Number	Blade Diameter		Depth of Cut		Free Speed rpm	Weight		Length		Air Consumption		Spindle Thread	Exhaust
	in	mm	in	mm		lb	kg	in	mm	scfm	l/s		
SCO7A184	4.0	100	1.2	30	18000	2.5	1.4	6.4	163	25	12	3/8"-24	Front
SCO10A106	6.0	150	2.0	51	10000	3.7	1.7	8.75	220	35	17	5/8"-11	Rear
SCO10A125	5.0	125	1.5	38	12000	3.5	1.6	8.75	220	35	17	5/8"-11	Rear
SCO10A184	4.0	100	1.2	30	18000	2.5	1.4	7.75	195	35	17	3/8"-24	Rear
SCO10AXL124	4.0	100	1.0	25	12000	3.6	1.6	11.25	285	35	17	3/8"-24	Rear

General: Air Inlet Size: 1/4" NPT • Recommended Hose Size: 3/8" (10 mm) • Performance rated @ 90 psig (6.2 bar) air pressure

Standard Equipment: Parts List • Safety and Instruction Manual • 1 Blade • Spindle Wrenches & Guard

Accessories: Cutoff Tool Accessories, see page 58



SAFETY PRECAUTION: Read and follow all safety and operating instructions.
WARNING: Face & eye protection must be worn while operating power tools, per ANSI B186.1

EXTENDED CUTOFF TOOLS (TYPE 1)



SCOA1AX124



SCOA1AX124G

Performance:

Power: 1 hp (0.75 kW)
 Speed: 12,000 rpm
 Collet Size: 1/4" & 6 mm

Features:

Lockoff Lever
 Robust Steel or Durable Aluminum Housing
 Available With Comfort Grip

Angle Extended Cutoff Tool



Model Number	Blade Diameter		Depth of Cut		Free Speed rpm	Weight		Length		Air Consumption		Spindle Thread	Exhaust
	in	mm	in	mm		lb	kg	in	mm	scfm	l/s		
1 hp (0.75 kW) – Aluminum Housing													
SCOA1AX124	4.0	100	1.0	25	12000	3.9	1.8	10.5	267	35	16.5	3/8" - 24	Front
1 hp (0.75 kW) – Aluminum Housing with Grip													
SCOA1AX124G	4.0	100	1.0	25	12000	3.6	1.6	10.5	267	35	16.5	3/8" - 24	Front
1 hp (0.75 kW) – Steel Housing													
SCOS1AX124	4.0	100	1.0	25	12000	4.5	2.0	10.5	267	35	16.5	3/8" - 24	Front
1 hp (0.75 kW) – Steel Housing with Grip													
SCOS1AX124G	4.0	100	1.0	25	12000	4.1	1.9	10.5	267	35	16.5	3/8" - 24	Front

General: Air Inlet Size: 1/4" NPT • Recommended Hose Size: 3/8" (10 mm) • Performance rated @ 90 psig (6.2 bar) air pressure

Standard Equipment: Parts List • Safety and Instruction Manual • 1 Blade • Spindle Wrenches & Guard

Accessories: Cutoff Tool Accessories, see page 58



SAFETY PRECAUTION: Read and follow all safety and operating instructions.
WARNING: Face & eye protection must be worn while operating power tools, per ANSI B186.1

Signature Series Collets



Part Number	Description
74071	Collet Nut
74072	Collet (1/8")
74073	Collet (3/16")
74074	Collet (1/4")
68030	Collet (3/8")
74075	Collet (3 mm)
74076	Collet (6 mm)
68056	Collet (8 mm)
77057	Collet Body SDG Series
74070	Collet Body (1 HP)
74070KIT	Includes 74070, 74071, 74074



Part Number	Description
74128	Collet Nut
74124	Collet (3/32")
74121	Collet (1/8")
74120	Collet (1/4")
74122	Collet (3 mm)
74123	Collet (6 mm)
77505	Collet Body SAS Series
74125	Collet Body SDG Series

Collets



Style	Capacity	Part Number	For Use On
Sioux	1/8"	44522	2S1940
	3/16"	44523	
	1/4"	44440	
	3 mm	66037	
	6 mm	66038	
100 Series	1/4"	21126B	1985
	3/8"	21125	
	1/2"	21124	

Belts and Erasers



Part Number	Description
SPPT280-300	11mm Hub Set
68815	Rubber Eraser
68814	Course Wire Belt, 23 mm Wide
68910	Course Wire Belt, 11 mm Wide
68911	Medium Wire Belt, 23 mm Wide
68912	Medium Wire Belt, 11 mm Wide
68813	Fine Wire Belt, 23 mm Wide
68913	Fine Wire Belt, 11 mm Wide
68916	Medium Stainless Steel Wire Belt, 23 mm Wide
68917	Medium Stainless Steel Wire Belt, 11 mm Wide
68914	Fine Stainless Steel Wire Belt, 23 mm Wide
68915	Fine Stainless Steel Wire Belt, 11 mm Wide

Diamond Blade

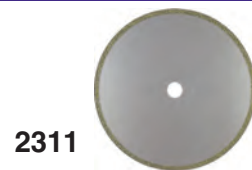

Part Number	Description
2311	4" Continuous-Rim Diamond Blade with 3/8" arbor hole

Sioux Swivel

Allows the air hose to rotate 360° on 2 axes.



Part Number	Description
1338-25	1/4" non-regulated air swivel connector with safety pin
1338-38	3/8" non-regulated air swivel connector with safety pin
1338-50	1/2" non-regulated air swivel connector with safety pin
1338FC-25	1/4" regulated air swivel connector with safety pin



SAFETY PRECAUTION: Read and follow all safety and operating instructions.
WARNING: Face & eye protection must be worn while operating power tools, per ANSI B186.1

FINISHING



Index

Sanders	61 – 66
Polishers	67 – 68
Finishing Accessories	69 – 70

FINISHING

The Best Way To A Great Finish

Today's manufacturing techniques are constantly changing and improving. This has increased the demands for sanders, polishers and buffers, making them a key segment of the process. Improvements in the industry now result in less waste on castings and molded parts, which shifts the emphasis from material removal to surface finishing. Sioux Tools offers a complete line of state-of-the-art orbital sanders, polishers and buffers that will produce the quality finish you require on your final product.

Sioux sanders are engineered to cover the full range of applications in metal, composite, and wood finishing. Our innovative, lightweight designs ensure they perform to the highest standards while still being comfortable to operate. Each delivers unsurpassed power and performance, resulting in the perfect finish.

Fit to your application

Different applications require different finishing tools. That's why Sioux Tools offers a variety of sanders and polishers with a wide range of configurations.

The RO2512 Series Random Orbital Sanders come with an orbit diameter of either 3/8" (10 mm), 3/16" (5 mm) or 3/32" (3 mm) and a choice of non-vacuum, self-contained Venturi vacuum or remote vacuum ready.

Variety to choose from

We also offer pistol grip, right angle, vertical, and straight sanders and polishers. Many of these come with your choice of throttle controls that allow the operator to work the way that's most comfortable.

Finishing Safety

Flying particles can cause eye injury. Proper eye protection must be worn at all times by tools user and bystanders.

A grinding wheel that bursts can cause injury or death. Never mount a grinding wheel or a cutoff wheel on a sander or polisher.

Breathing grinding dust can cause injury. Do not breathe grinding dust. Use approved mask.

Sanders and polishers that do not come to a complete stop before setting aside can cause injury. Be sure the tool has come to a complete stop before setting it aside.

Explosions and fires can cause injury. Only sand metal if the area is free of combustible or explosive materials or vapors.

Contact with sanding disks can cause injury. Wear protective clothing and gloves to protect hands. Keep hands and other body parts away from sanding pads and disks to prevent cutting or pinching.

Sanding or polishing pads, disks or accessories that burst can cause injury. Make sure disks or accessories have a higher speed rating than the tool. Do not exceed rated air pressure.

Prolonged exposure to vibration or an excessive exposed portion of the edge of a disk can cause injury. When using self adhesive sanding disks, make sure to mount them concentrically on the pad.

Tools starting unexpectedly can cause injury. Always remove tool from air supply and activate trigger to bleed air line before making any adjustments, changing accessories, or doing any maintenance or service on tool.

Tools that perform unpredictably can cause injury. Use only sanding and polishing pads, disks and accessories provided or specified by Sioux Tools.



RO2512-50SNP



SAG03S20



SAS03S122-20

SIGNATURE SERIES RANDOM ORBITAL SANDERS



RO2512-50SNP



RO2512-50SRP



RO2512-50FVP

Performance:

Power: 0.25 hp (0.19 kW)
Speed: 12,000 rpm

Features:

3/32" (3 mm), 3/16" (5 mm) & 3/8" (10 mm) Orbit Diameters
Built-in Speed Control
Ergonomic 24-Position Indexable Grip
Non-Vacuum, Venturi Vacuum & Remote Vacuum

RO2512 Series Random Orbital Sanders



Model Number		Free Speed rpm	Pad Size		Orbit Diameter		Weight		Height		Air Consumption	
PSA Pad	H & L Pad		in	mm	in	mm	lb	kg	in	mm	scfm	l/s
0.25 hp (0.19 kW) – 5/16"-24 Spindle Thread – Non-Vacuum												
RO2512-30FNP	RO2512-30FNH	12000	3.0	75	3/32	3	1.5	0.7	3.3	83	13	6
RO2512-30SNP	RO2512-30SNH	12000	3.0	75	3/16	5	1.5	0.7	3.3	83	13	6
RO2512-35FNP	RO2512-35FNH	12000	3.5	90	3/32	3	1.5	0.7	3.3	83	13	6
RO2512-35SNP	RO2512-35SNH	12000	3.5	90	3/16	5	1.5	0.7	3.3	83	13	6
RO2512-50FNP	RO2512-50FNH	12000	5.0	125	3/32	3	1.5	0.7	3.3	83	13	6
RO2512-50SNP	RO2512-50SNH	12000	5.0	125	3/16	5	1.5	0.7	3.3	83	13	6
RO2512-50CNP	RO2512-50CNH	12000	5.0	125	3/8	10	1.5	0.7	3.3	83	13	6
RO2512-60FNP	RO2512-60FNH	12000	6.0	150	3/32	3	1.5	0.7	3.3	83	13	6
RO2512-60SNP	RO2512-60SNH	12000	6.0	150	3/16	5	1.5	0.7	3.3	83	13	6
RO2512-60CNP	RO2512-60CNH	12000	6.0	150	3/8	10	1.5	0.7	3.3	83	13	6
0.25 hp (0.19 kW) – 5/16"-24 Spindle Thread – Remote Vacuum Ready												
RO2512-30FRP	RO2512-30FRH	12000	3.0	75	3/32	3	1.5	0.7	3.3	83	13	6
RO2512-30SRP	RO2512-30SRH	12000	3.0	75	3/16	5	1.5	0.7	3.3	83	13	6
RO2512-35FRP	RO2512-35FRH	12000	3.5	90	3/32	3	1.5	0.7	3.3	83	13	6
RO2512-35SRP	RO2512-35SRH	12000	3.5	90	3/16	5	1.5	0.7	3.3	83	13	6
RO2512-50FRP	RO2512-50FRH	12000	5.0	125	3/32	3	1.5	0.7	3.3	83	13	6
RO2512-50SRP	RO2512-50SRH	12000	5.0	125	3/16	5	1.5	0.7	3.3	83	13	6
RO2512-50CRP	RO2512-50CRH	12000	5.0	125	3/8	10	1.5	0.7	3.3	83	13	6
RO2512-60FRP	RO2512-60FRH	12000	6.0	150	3/32	3	1.5	0.7	3.3	83	13	6
RO2512-60SRP	RO2512-60SRH	12000	6.0	150	3/16	5	1.5	0.7	3.3	83	13	6
RO2512-60CRP	RO2512-60CRH	12000	6.0	150	3/8	10	1.5	0.7	3.3	83	13	6
0.25 hp (0.19 kW) – 5/16"-24 Spindle Thread – Self-contained Venturi Vacuum												
RO2512-30FVP	RO2512-30FVH	12000	3.0	75	3/32	3	1.5	0.7	3.3	83	13	6
RO2512-30SVP	RO2512-30SVH	12000	3.0	75	3/16	5	1.5	0.7	3.3	83	13	6
RO2512-35FVP	RO2512-35FVH	12000	3.5	90	3/32	3	1.5	0.7	3.3	83	13	6
RO2512-35SVP	RO2512-35SVH	12000	3.5	90	3/16	5	1.5	0.7	3.3	83	13	6
RO2512-50FVP	RO2512-50FVH	12000	5.0	125	3/32	3	1.5	0.7	3.3	83	13	6
RO2512-50SVP	RO2512-50SVH	12000	5.0	125	3/16	5	1.5	0.7	3.3	83	13	6
RO2512-50CVP	RO2512-50CVH	12000	5.0	125	3/8	10	1.5	0.7	3.3	83	13	6
RO2512-60FVP	RO2512-60FVH	12000	6.0	150	3/32	3	1.5	0.7	3.3	83	13	6
RO2512-60SVP	RO2512-60SVH	12000	6.0	150	3/16	5	1.5	0.7	3.3	83	13	6
RO2512-60CVP	RO2512-60CVH	12000	6.0	150	3/8	10	1.5	0.7	3.3	83	13	6

General: Air Inlet Size: 1/4" NPT • Recommended Hose Size: 3/8" (10 mm) • Performance rated @ 90 psig (6.2 bar) air pressure

Standard Equipment: Parts List • Safety and Instruction Manual • Comfort Grip • Backing Pad & Wrench

Accessories: Sander Accessories, see pages 69 – 70



SAFETY PRECAUTION: Read and follow all safety and operating instructions.
WARNING: Face & eye protection must be worn while operating power tools, per ANSI B186.1

ORBITAL JITTERBUG SANDER

Performance:

Power: 0.25 hp (0.19 kW)
 Speed: 10,000 rpm

Features:

Built-in Speed Control
 Ergonomic 24-Position Indexable Grip



RO2510-44FNC



Orbital Jitterbug Sanders

Model Number	Paper Size		Orbit Diameter		Weight		Height		Air Consumption	
	in	mm	in	mm	lb	kg	in	mm	scfm	l/s
0.25 hp (0.19 kW)										
RO2510-44FNC	3-3/4 x 4-1/4	95 x 105	3/32	3	1.8	0.8	3.5	90	13	6

General: Air Inlet Size: 1/4" NPT • Recommended Hose Size: 3/8" (10 mm) • Performance rated @ 90 psig (6.2 bar) air pressure

Standard Equipment: Parts List • Safety and Instruction Manual

Accessories: Sander Accessories, see pages 69 – 70

GEARED ORBITAL SANDERS



GO459-60SNP



GO459-80SRP

Performance:

Power: 0.45 hp (0.34 kW)
 Speed: 900 rpm

Features:

3/16" (5 mm) Orbit Diameter
 Built-in Speed Control
 Lever Throttle
 Vacuum & Remote Vacuum
 Ergonomic 24-Position Indexable Grip

Geared Orbital Sanders



Model Number		Free Speed rpm	Pad Size		Weight		Height		Air Consumption	
PSA Pad	H & L Pad		in	mm	lb	kg	in	mm	scfm	l/s
0.45 hp (0.34 kW) Non-Vacuum										
GO459-60SNP	GO459-60SNH	900	6.0	150	4.4	2.0	5.0	127	15	7
GO459-80SNP	GO459-80SNH	900	8.0	200	4.4	2.0	5.0	127	15	7
0.45 hp (0.34 kW) Remote Vacuum										
GO459-60SRP	GO459-60SRH	900	6.0	150	4.4	2.0	5.0	127	15	7
GO459-80SRP	GO459-80SRH	900	8.0	200	4.4	2.0	5.0	127	15	7

General: Air Inlet Size: 1/4" NPT • Recommended Hose Size: 3/8" (10 mm) • Performance rated @ 90 psig (6.2 bar) air pressure

Standard Equipment: Parts List • Safety and Instruction Manual

Accessories: Sander Accessories, see pages 69 – 70



SAFETY PRECAUTION: Read and follow all safety and operating instructions.
WARNING: Face & eye protection must be worn while operating power tools, per ANSI B186.1

PISTOL GRIP SANDERS



SPS10P18



SDG10P18

Performance:

Power: 1 hp (0.75 kW)
 Speed: 6,000 rpm – 21,000 rpm

Features:

Trigger Start
 Down-Handle Exhaust
 Comfort Grip

Pistol Grip Sanders



Model Number	Free Speed	Weight		Length		Air Consumption	
	rpm	lb	kg	in	mm	scfm	l/s
1 hp (0.75 kW) – 5" (125 mm) Sanding Discs with 7/8" Hole							
SPS10P6	6000	2.0	0.8	4.9	115	35	17
SPS10P18	18000	1.7	0.8	4.5	115	35	17
1 hp (0.75 kW) – 1/4" Collet							
SDG10P18	18000	1.7	0.8	5.8	145	35	17
SDG10P21	21000	1.7	0.8	5.8	145	35	17

General: Air Inlet Size: 1/4" NPT • Recommended Hose Size: 3/8" (10 mm) • Performance rated @ 90 psig (6.2 bar) air pressure

Standard Equipment: Parts List • Safety and Instruction Manual • Comfort Grip • Backing Pad (SPS only)

Accessories: Sander Accessories, see pages 69 – 70



SAFETY PRECAUTION: Read and follow all safety and operating instructions.

WARNING: Face & eye protection must be worn while operating power tools, per ANSI B186.1

RIGHT ANGLE SANDERS



Performance:

Power: 0.3 hp (0.22 kW) – 1 hp (0.37 kW)
 Speed: 3,300 rpm – 23,000 rpm

Features:

Lockoff Lever Throttle
 Rear Exhaust
 Comfort Grip

Right Angle Disc Sanders –



Model Number	Free Speed	Weight		Length		Air Consumption		Spindle Thread
	rpm	lb	kg	in	mm	scfm	l/s	
0.3 hp (0.22 kW) – 1/4"-20 Internal Thread								
SAS03S122-20	12000	1.1	0.5	5.6	143	11	5.2	1/4"-20
SAS03S202-20	20000	1.1	0.5	5.6	143	11	5.2	1/4"-20
0.5 hp (0.37 kW) – 1/4"-20 Internal Thread								
SAS05S122-20	12000	1.6	0.73	6.9	175	23	11	1/4"-20
SAS05S152-20	15000	1.6	0.73	6.9	175	23	11	1/4"-20
SAS05S182-20	18000	1.6	0.73	6.9	175	23	11	1/4"-20
SAS05S232-20	23000	1.5	0.59	6.4	143	23	11	1/4"-20
0.5 hp (0.37 kW) – 200 Series Collet								
SAG05S33	3300	2.2	1.0	8.2	208	23	11	N/A
SAG05S54	5400	2.2	1.0	8.2	208	23	11	N/A
1 hp (0.75 kW) – 1/4"-20 Internal Thread								
SAS10A122-20	12000	2.15	0.98	7.5	190	30	14	1/4"-20
SAS10A152-20	15000	2.15	0.98	7.5	190	30	14	1/4"-20
SAS10A182-20	18000	2.15	0.98	7.5	190	30	14	1/4"-20

General: Air Inlet Size: 1/4" NPT • Recommended Hose Size: 3/8" (10 mm) • Performance rated @ 90 psig (6.2 bar) air pressure

Standard Equipment: Parts List • Safety and Instruction Manual • Support Handle (1 hp Models) • Spindle Wrenches • 1/4"-20 Threaded Arbor • Backing Pad & Nut

Accessories: Sander Accessories, see pages 69 – 70

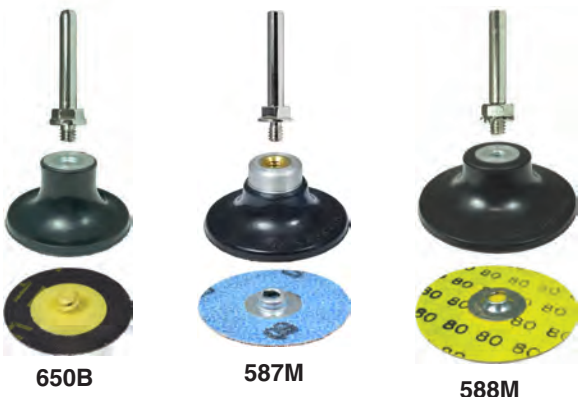

Features:

1/4" Shank
 1/4"-20 Thread

Speed-Lok Backing Pads

Part Number	Type	Diameter		Max. rpm
		in	mm	
650B	R (plastic)	2	50	30000
587M	S (metal)	2	50	30000
588M	S (metal)	3	75	20000

*Sanding Disc Not Included



SAFETY PRECAUTION: Read and follow all safety and operating instructions.
WARNING: Face & eye protection must be worn while operating power tools, per ANSI B186.1

RIGHT ANGLE SANDERS



SAS10A324



SAS10SX125



SASG10SX807N



SAS10S125



1287L



AS16S125



AS22S847

Performance:

Power: 1 hp (0.75 kW) – 2.2 hp (1.6 kW)
 Speed: 3,200 rpm – 12,000 rpm

Features:

Governed & Non-Governed
 Lockoff Lever Throttle
 Rear Exhaust on SAS Series

Right Angle Sanders – External Thread Spindle



Model Number	Free Speed	Pad Diameter		Weight		Length		Air Consumption Under Load		Air Consumption Free Speed		Spindle Thread
	rpm	in	mm	lb	kg	in	mm	scfm	l/s	scfm	l/s	
1 hp (0.75 kW) – Medium Duty Head – Non-Governed Speed												
SAS10A324	3200	5.0	125	2.8	1.3	9.25	235	N/A	N/A	35	17	3/8"-24
SAS10A607	6000	7.0	178	2.9	1.3	9.2	234	N/A	N/A	35	17	5/8"-11
SAS10A125	12000	5.0	125	2.2	1.0	7.75	134	N/A	N/A	35	17	5/8"-11
SAS10AX125	12000	5.0	125	3.2	1.45	11.25	285	N/A	N/A	35	17	5/8"-11
1 hp (0.75 kW) – Heavy Duty Head – Non-Governed Speed												
SAS10S905	9000	5.0	127	3.5	1.6	8.3	211	N/A	N/A	35	17	5/8"-11
SAS10S125	12000	5.0	125	2.6	1.2	8.3	210	N/A	N/A	35	17	5/8"-11
SASG10SX807N	8000	5.0	125	4.4	2.0	11.7	300	N/A	N/A	35	17	5/8"-11
SAS10SX125	12000	5.0	125	3.6	1.6	11.7	300	N/A	N/A	35	17	5/8"-11
1.2 hp (0.9 kW) – Governed Speed Control												
1287L ¹	6000	7.0	175	5.9	2.7	11.3	287	43	20	22	10	5/8"-11
1.6 hp (1.2 kW) – Governed Speed Control												
AS16S125	12000	5	125	3.8	1.7	2.7	65	53	25	40	19	5/8"-11
2.2 hp (1.6 kW) – Governed Speed Control												
AS22S847	8400	7	175	6.1	2.8	3.2	80	60	28	45	21	5/8"-11

¹Not CE certified.

General: Air Inlet Size: 1/4" NPT (1287L); 3/8" NPT (AS) • Recommended Hose Size: 3/8" (10 mm) (1287L); 1/2" (13mm) (AS)

Performance rated @ 90 psig (6.2 bar) air pressure

Standard Equipment: Parts List • Safety and Instruction Manual • Support Handle • Spindle Wrenches • Backing Pad & Nut (except SASG10SX807N)

Accessories: Sander Accessories, see pages 69 – 70



SAFETY PRECAUTION: Read and follow all safety and operating instructions.
WARNING: Face & eye protection must be worn while operating power tools, per ANSI B186.1

VERTICAL SANDERS



1290



VS40S807



1290L



VS40S609

Performance:

Power: 1 hp (0.75 kW) – 4 hp (2.9 kW)
 Speed: 5,000 rpm – 8,000 rpm

Features:

Governed & Non-Governed
 Lever & Thumb Throttle
 Side Exhaust
 2-Stage Throttle (VS Series)

Vertical Sanders



Model Number	Free Speed		Pad Diameter		Weight		Length		Air Consumption Under Load		Air Consumption Free Speed		Spindle Thread
	rpm		in	mm	lb	kg	in	mm	scfm	l/s	scfm	l/s	
1.2 hp (0.9 kW) – Non-Governed – Thumb Throttle													
1290	5000		7.0	175	4.1	1.9	7.2	183	N/A	N/A	38	18	5/8"-11
1 hp (0.75 kW) – Non-Governed – Lever Throttle													
1290L	6000		7.0	175	4.1	1.9	7.2	183	N/A	N/A	38	18	5/8"-11
4 hp (2.9 kW) – Vertical Sanders – Governed Speed Control													
VS40S607	6000		7.0	175	7.9	3.6	6.8	175	70	33	40	19	5/8"-11
VS40S807	8000		7.0	175	7.9	3.6	6.8	175	70	33	40	19	5/8"-11
VS40S609	6000		9.0	230	7.9	3.6	6.8	175	70	33	40	19	5/8"-11

General: Air Inlet Size: 1/4" NPT (1290, 1290L); 1/2" NPT (VS Series) • Recommended Hose Size: 3/8" (10 mm) (1290, 1290L) 3/4" (19 mm) (VS Series)
 Performance rated @ 90 psig (6.2 bar) air pressure

Standard Equipment: Parts List • Safety and Instruction Manual • Spindle Wrenches • Backing Pad & Nut

Accessories: Sander Accessories, see pages 69 – 70



SAFETY PRECAUTION: Read and follow all safety and operating instructions.
WARNING: Face & eye protection must be worn while operating power tools, per ANSI B186.1

ANGLE POLISHERS

Performance:

Power: 1 hp (0.75 kW)
 Speed: 2,200 rpm – 4,500 rpm

Features:

Governed & Non-Governed
 Lockoff Lever Throttle
 Spindle Lock
 Rear Exhaust (SAP)
 Side Exhaust (1238L)



SAP10A327



1238L

Right Angle Polishers



Model Number	Free Speed	Pad Diameter		Weight		Length		Air Consumption Under Load		Air Consumption Free Speed		Spindle Thread
	rpm	in	mm	lb	kg	in	mm	scfm	l/s	scfm	l/s	
1 hp (0.75 kW) - Non-Governed												
SAP10S227	2200	sold separately		3.3	1.5	9.8	249	N/A	N/A	35	17	5/8"-11
SAP10A327	3200	sold separately		2.9	1.3	9.2	234	N/A	N/A	35	17	5/8"-11
SAP10A457	4500	sold separately		2.9	1.3	9.2	234	N/A	N/A	35	17	5/8"-11
1.2 hp (0.9 kW) – Governed Speed Control												
1238L	3000	8.0	200	7.9 ¹	3.6	11.3	287	33	16	16	8	5/8"-11

¹ Weight includes pad & holder.

General: Air Inlet Size: 1/4" NPT • Recommended Hose Size: 3/8" (10 mm) • Performance rated @ 90 psig (6.2 bar) air pressure

Standard Equipment: (SAP) Parts List • Safety and Instruction Manual • Support Handle • Spindle Wrench

(1238L) Parts List • Safety and Instruction Manual • Support Handle • Backing Pad & Nut • Wool Polishing Pad • Spindle Wrench

Accessories: Polisher Accessories, see pages 69 – 70



WARNING



SAFETY PRECAUTION: Read and follow all safety and operating instructions.

WARNING: Face & eye protection must be worn while operating power tools, per ANSI B186.1

VERTICAL POLISHERS

Performance:

Power: 1 hp (0.75 kW)
 Speed: 2,000 rpm – 3,000 rpm

Features:

Lever & Thumb Throttle
 Side Exhaust
 Comfort Grips



Vertical Polishers



Model Number	Free Speed	Pad Diameter		Weight ¹		Length		Air Consumption		Spindle Thread
	rpm	in	mm	lb	kg	in	mm	scfm	l/s	
1 hp (0.75 kW) – Thumb Throttle										
1296	2000	8.0	200	4.1	1.9	7.1	180	38	18	5/8"-11
1292	3000	8.0	200	4.1	1.9	7.1	180	38	18	5/8"-11
1 hp (0.75 kW) – Lever Throttle										
1292L	3000	8.0	200	4.1	1.9	7.1	180	38	18	5/8"-11

¹ Weight includes pad & holder.

General: Air Inlet Size: 1/4" NPT • Recommended Hose Size: 3/8" (10 mm) • Performance rated @ 90 psig (6.2 bar) air pressure

Standard Equipment: Parts List • Safety and Instruction Manual • Spindle Wrenches • Backing Pad & Nut • Polishing Pad

Accessories: Polisher Accessories, see pages 69 – 70

8" POLISHING ACCESSORIES



Part Number	Description
846C*	Backing pad (Includes 524)
524*	Retaining nut
1211B*	Wool polishing pad (pkg 10)
847	Hook & loop backing pad
1220	Hook & loop polishing pad (pkg 10)
843	Tie-on wool bonnet (pkg 10)

* Standard equipment on polishers



SAFETY PRECAUTION: Read and follow all safety and operating instructions.
WARNING: Face & eye protection must be worn while operating power tools, per ANSI B186.1

Speed-Lok Backing Pads

For use on SAS series sanders

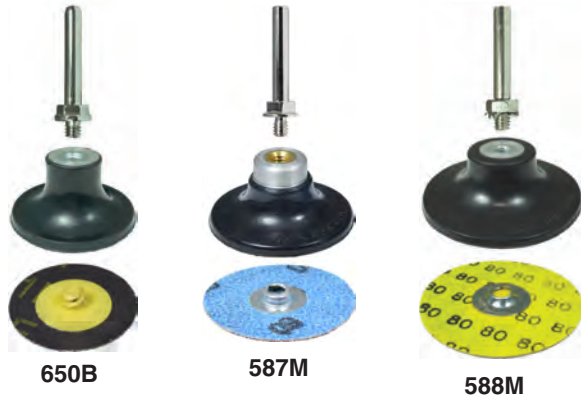

Features:

1/4" Shank
1/4"-20 Thread

Part Number	Type	Diameter		Max. rpm
		in	mm	
650B	R (plastic)	2	50	30000
587M	S (metal)	2	50	30000
588M	S (metal)	3	75	20000

*Sanding Disc Not Included

Fibre Backing Discs

Part No 586

For use on SPS10P series sanders

Packaged in cartons of 6

Qty 3 – 3" (75 mm)

Qty 3 – 4-1/2" (110 mm)



5" Backing Pad – Dual Thread

For use on SAS10 & SPS10P series sanders



Part Number	Thread	Diameter	
		in	mm
2344	3/8-24 & 5/8-11	5	125

Includes disc nut 30750

7" & 9" SANDER BACKING PAD KITS



Part Number	Thread	Stiffness	Max RPM	Diameter	
				in	mm
SP510308-KIT	5/8-11	Stiff (Nylon)	10000	7	175
SP510309-KIT	5/8-11	Stiff (Nylon)	9000	9	230
SP510310-KIT	5/8-11	Soft (Rubber)	8500	7	175



Part Number	Description
545 Standard Fiberglass Kit	
544	Disc holder
548	Backing disc with lock nut
68015	Wrench
545H Heavy-Duty Fiberglass Kit	
544	Disc holder
548H	Heavy-duty backing disc with lock nut
68015	Wrench



SAFETY PRECAUTION: Read and follow all safety and operating instructions.
WARNING: Face & eye protection must be worn while operating power tools, per ANSI B186.1

Orbital Sander Backing Pads

Sioux random orbital backing pads are medium density, urethane pads rated for speeds up to 13,000 rpm. The 5" pads are a 3/8" thick with low profile design, while the 6" pads are 5/8" thick with tapered profile for fine feathering in corners or around edges.

5/16" - 24 Spindle Thread

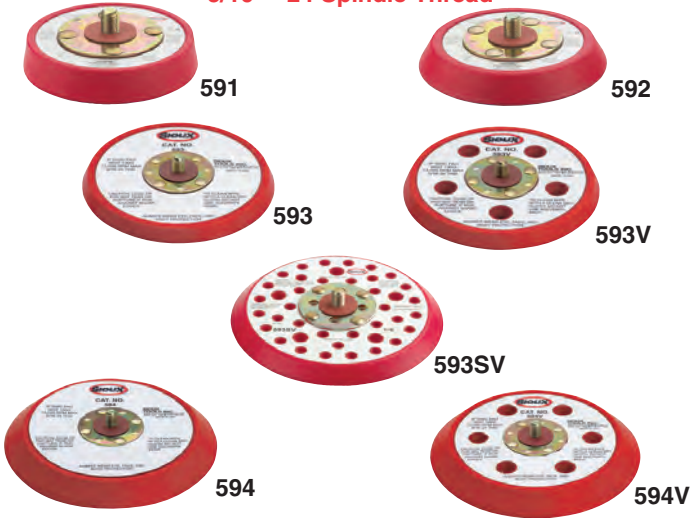

Part Number	Diameter		Backing	Profile	Style
	in	mm			
591	3	75	PSA	Low	Vac/Non-Vac
591J	3	75	H & L	Low	Vac/Non-Vac
592	3.5	90	PSA	Tapered	Vac/Non-Vac
592J	3.5	90	H & L	Tapered	Vac/Non-Vac
593	5	125	PSA	Low	Non-Vac
593V	5	125	PSA	Low	Vacuum
593J	5	125	H & L	Low	Non-Vac
593JV	5	125	H & L	Low	Vacuum
593SV	5	125	PSA	Low	Screen Vac
594	6	150	PSA	Tapered	Non-Vac
594V	6	150	PSA	Tapered	Vacuum
594J	6	150	H & L	Tapered	Non-Vac
594JV	6	150	H & L	Tapered	Vacuum
594SV	6	150	PSA	Low	Screen Vac

PSA – Vinyl face for pressure sensitive adhesive sanding discs
 H & L – Hook and loop face

8" Polishing Accessories



Part Number	Description
846C*	Backing pad (Includes 524)
524*	Retaining nut
1211B*	Wool polishing pad (pkg 10)
847	Hook & loop backing pad
1220	Hook & loop polishing pad (pkg 10)
843	Tie-on wool bonnet (pkg 10)

* Standard equipment on polishers

Dustless Vacuum Shrouds

Random Orbital Sander Vacuum Shroud Sioux Models RO25VS-5 and RO25VS-6



- Fit RO25 Series Random Orbital Sanders
- Available For 5" Or 6" Sanders
- Captures 99% Of Airborne Dust
- Protects Workers From Harmful Airborne Dust
- Flexible And Transparent For Better Visibility
- Includes 6 Ft. Vacuum Hose

Part Number	Description
RO25VS-5	5" Vacuum Shroud
RO25VS-6	6" Vacuum Shroud



SAFETY PRECAUTION: Read and follow all safety and operating instructions.
WARNING: Face & eye protection must be worn while operating power tools, per ANSI B186.1

PERCUSSIVE



WARNING

PREVENT WHEEL SEPARATION

RECOMMENDED TIGHTENING TORQUE FOR DISC WHEEL MOUNTING NUTS IS 48-60 LB-FT APPLIES TO BALL BEAR AND HUB-PILOT MOUNTING SYSTEMS WITH 24-36 SPINDLE 1.5 STUDS FOR ALUMINUM AND STEEL WHEELS. CHECK NUTS FREQUENTLY 60-100 MILES AFTER INITIAL IN-SERVICE DATE AND AT INTERVALS NOT TO EXCEED 25,000 MILES AND TIGHTEN TO MAINTAIN RECOMMENDED TORQUE.

FAILURE TO HEED THIS WARNING CAN RESULT IN PROPERTY DAMAGE, SERIOUS INJURY OR DEATH.

Index	
Scalers	73 – 74
Hammers	74
Percussive Accessories	75 – 76

PERCUSSIVE

Hammering Home A Point

Percussive tools, such as hammers, chippers and scalers are commonly used in very abusive environments found in industries such as foundry and construction. Sioux Tools offers a variety of sizes, capacities and accessories built durable to ensure long life under tough operating conditions. We build them to work hard on the job, but not on you!

Industrial Tools

Sioux offers powerful hammers that deliver up to 2,500 blows per minute (bpm), with steel rivet capacities of 5/32" (4 mm) to 1/4" (6.4 mm) and stroke lengths from 2" (50 mm) to 4" (100 mm).

Percussive Safety

Never operate a hammer without proper retainer in place. Always disconnect air line before changing chisels. Face and eye protection must be worn while operating tools. All chisels, rivet sets and other accessories should be checked for cracks, excessive wear, or other physical damage before each use. Accessories that show damage should be replaced immediately.



SQUARE SHANK SCALERS



SC41011AL-C



SC41011AU-N5

Performance:

Stroke: 1.1" (28 mm)
 Bore: 1" (25 mm)
 Blows per Minute: 4,600

Features:

Lever and Push/Pull Start
 Quick Release Retainer
 Adjustable Needle Length

SC4 series scalers accept notched, square shank chisels and accessories. Each can be quickly converted between chisel and needle styles.



Square Shank



Square Shank Scalers

Model Number	Stroke Length		Bore Diameter		Blows per Minute	Weight		Length		Side To Center		Air Consumption	
	in	mm	in	mm		lb	kg	in	mm	in	mm	scfm	l/s
Chisel Scaler – Lever Throttle													
SC41011AL-C	1.1	28	1.0	25	4600	4.6	2.1	10.5	263	0.9	23	12	6
Chisel Scaler – Push/Pull Throttle													
SC41011AU-C	1.1	28	1.0	25	4600	4.6	2.1	12.0	300	0.9	23	12	6
Needle Scaler – Lever Throttle													
SC41011AL-N5	1.1	28	1.0	25	4600	6.3	2.9	15.3	383	1.0	25	12	6
Needle Scaler – Push/Pull Throttle													
SC41011AU-N5	1.1	28	1.0	25	4600	6.3	2.9	16.8	420	1.0	25	12	6

General: Air Inlet Size: 1/4" NPT • Recommended Hose Size: 3/8" (10 mm) • Performance rated @ 90 psig (6.2 bar) air pressure
Standard Equipment: Parts List • Safety and Instruction Manual • 7" flat chisel (chisel scalers) • 5" scaler needles (needle scalers)
Accessories: Scaler Accessories, see pages 75 – 76

OCTAGON SHANK SCALERS



SC80910AL-C



SC80910AL-N5

Performance:

Stroke: 1" (25 mm)
 Bore: 15/16" (23 mm)
 Blows per Minute: 4,300

Features:

Lever Throttle
 Quick Release Retainer
 Adjustable Needle Length

SC8 series scalers accept notched, octagon shank chisels and accessories. Each can be quickly converted between chisel and needle styles.



Octagon Shank



Octagon Shank Scalers

Model Number	Stroke Length		Bore Diameter		Blows per Minute	Weight		Length		Side To Center		Air Consumption	
	in	mm	in	mm		lb	kg	in	mm	in	mm	scfm	l/s
Chisel Scaler – Octagon Shank – Lever Throttle													
SC80910AL-C	1.0	25	15/16	23	4300	4.0	1.7	15	375	0.8	20	12	6
Needle Scaler – Octagon Shank – Lever Throttle													
SC80910AL-N5	1.0	25	15/16	23	4300	6.2	2.7	17	425	0.9	23	12	6

General: Air Inlet Size: 1/4" NPT • Recommended Hose Size: 3/8" (10 mm) • Performance rated @ 90 psig (6.2 bar) air pressure
Standard Equipment: Parts List • Safety and Instruction Manual • 7" flat chisel (chisel scalers) • 5" scaler needles (needle scalers)
Accessories: Scaler Accessories, see pages 75 – 76



SAFETY PRECAUTION: Read and follow all safety and operating instructions.
WARNING: Face & eye protection must be worn while operating power tools, per ANSI B186.1

SCALER KITS

SC4 Scaler Kit

Part No. SC41011AL-K

- SC4 Lever Needle Scaler
- Additional Set of Needles
- 3/4" x 7" Flat Chisel
- 1-3/8" x 7" Flat Chisel
- 1-3/8" x 7" Spoon Chisel
- Custom Carrying Case



SC8 Scaler Kit

Part No. SC80910AL-K

- SC8 Needle Scaler
- Additional Set of Needles
- 3/4" x 7" Flat Chisel
- 1-3/8" x 7" Flat Chisel
- 1-3/8" x 7" Spoon Chisel
- Custom Carrying Case



HAMMERS

Performance:

Rivet Capacity: 5/32" (4.0 mm) – 1/4" (6.4 mm)
 Stroke: 2" (50 mm) – 4" (100 mm)
 Bore: 9/16" (14.3 mm)

Features:

Pistol Grip
 Teasing Throttle Trigger Start
 Accepts .401 Parker Taper Rivet Sets and Chisels



Hammers

Model Number	Steel Rivet Capacity		Stroke Length		Bore Diameter		Blows per Minute	Weight		Length		Side To Center		Air Consumption	
	in	mm	in	mm	in	mm		lb	kg	in	mm	in	mm	scfm	l/s
270A-2	5/32	4.0	2.0	50	9/16	14.3	2500	3.0	1.4	5.8	147	1.1	28	8	4
270A	3/16	4.8	3.0	75	9/16	14.3	2000	3.2	1.5	6.8	173	1.1	28	8	4
270A-4	1/4	6.4	4.0	100	9/16	14.3	1700	3.5	1.6	7.8	198	1.1	28	8	4

General: Air Inlet Size: 1/4" NPT • Recommended Hose Size: 3/8" (10 mm) • Performance rated @ 90 psig (6.2 bar) air pressure

Standard Equipment: Parts List • Safety and Instruction Manual • Beehive Retainer

Accessories: Hammer Accessories, see pages 75 – 76



SAFETY PRECAUTION: Read and follow all safety and operating instructions.
WARNING: Face & eye protection must be worn while operating power tools, per ANSI B186.1

Scaler Accessories

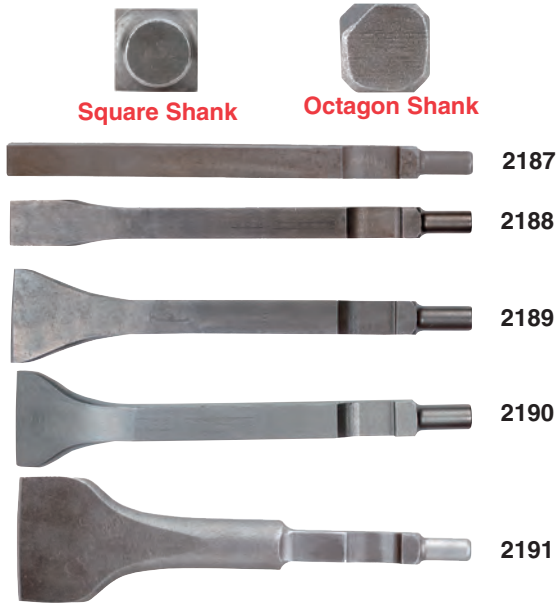

SC4 Chisels	SC8 Chisels	Description	Length		Width	
			in	mm	in	mm
2187	2287	Hardened Blank	7	175	5/8	16
2188	2288	Flat Chisel	7	175	3/4	19
2189	2289	Flat Chisel	7	175	1-3/8	35
2190	2290	Spoon Chisel	7	175	1-3/8	35
2191	2291	Flat Chisel	7	175	2	50
2192	2292	Flat Chisel	12	300	5/8	16
2193	2293	Flat Chisel	12	300	1-3/8	35
2194	2294	Spoon Chisel	12	300	1-3/8	35
2195	2295	Flat Chisel	12	300	2	50
2196	2296	Flat Chisel	18	450	5/8	16
2197	2297	Flat Chisel	18	450	1-3/8	35
2198	2298	Spoon Chisel	18	450	1-3/8	35
2199	2299B	Flat Chisel	18	450	2	50

270 Rivet Sets

.401 Parker Taper Shank



Rivet Head Cupping	Rivet Diameter Size				
	3/32" Part No	1/8" Part No	5/32" Part No	3/16" Part No	1/4" Part No
Button Head	N/A	2229	2230B	2231	2244*
Round Head	2232	2233	2234B	2235	2245*
Brazier Head	2236	2237B	2238	2239	2246*
Universal Head	2240	2241B	2242B	2243B*	2247*

3-1/2" (90 mm) overall length

* Use 2208 Retainer

Rivet Set Profiles

Standard Rivet Head Profiles

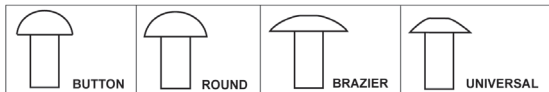

270A Hammer Accessories

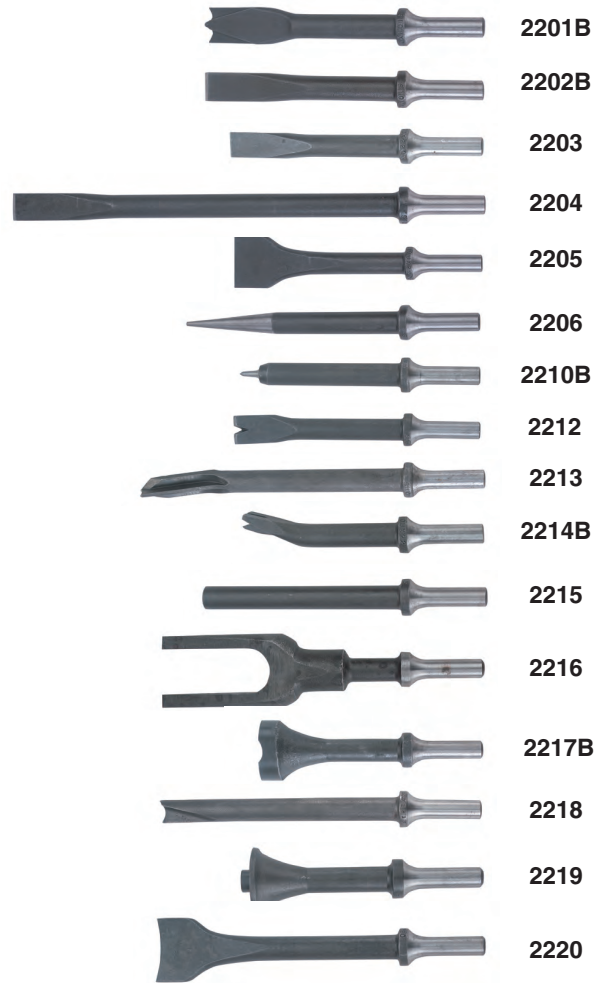

270A Chisels	Description	Width		Length	
		in	mm	in	mm
2201B*	Cutter	5/8	16	6	150
2202B	Chisel	5/8	16	6	150
2203	Rivet Buster	5/8	16	5-1/2	140
2204	Expansion Chisel	5/8	16	11	280
2205*	Scraper	1-1/4	30	6	150
2206	Punch			7	175
2210B	Punch			5	127
2212	Spot Weld Breaker			6	150
2213	Splitter			8	200
2214B	Edging Chisel			5	140
2215	Blank Chisel			6	150
2216*	Fork Chisel			6-7/8	175
2217B*	Rust Breaker			5-1/4	135
2218	Bushing Cutter			7	175
2219*	Bushing Driver			4-1/2	115
2220*	Bushing Chisel	1-5/8	40	7	175

* Use 2208 Retainer



SAFETY PRECAUTION: Read and follow all safety and operating instructions. **WARNING:** Face & eye protection must be worn while operating power tools, per ANSI B186.1

Scaling Needles



Part Number	Diameter	Length	Quantity	Used On
2260B	0.12"	5"	19	SC4, SC8 Scalers
2262	0.12"	7"	19	SC4, SC8 Scalers

Beehive Spring Retainers



2207



2208

Part Number	Description
2207	Chisel Retainer Spring (Use with all except those listed below)
2208	Must use 2208 with 2201B, 2205, 2216, 2217B, and 2219, 2220, 2239, 2244, 2245, 2246, 2247

Hammer Chuck



2270

Part Number	Description	For Use ON
2270	Quick change air hammer chuck	270A

SPECIALTY



Index		Rivet Shavers	83
Routers	79	Saws	84
Clinch Nut Tools	81	Nibblers & Shears	85
Tappers	82	Aerospace	87 – 88
Skin Clamp Runners	82	Specialty Accessories	89 – 90

SPECIALTY

Special Applications Require Special Tools

Sioux Tools has a superb selection of specialty tools designed for very specific applications, and as always, we manufacture the finest tools in the industry.

Routers

Sioux offers a selection of routers and laminate trimmers in 1.0 hp (0.75 kW) or 1.5 hp (1.1 kW) configurations. They feature lockoff lever, twist or finger throttles and come with a selection of different bases.

Tappers

Choose from pistol grip or inline configurations. The pistol grip offers chuck capacity from No. 10 thru 1/2" size.

Nibbler and Shear

Our 1.0 hp (0.75 kw) nibbler and shear has the power for use on cold rolled sheet steel up to 18 gauge.



Shears

This versatile tool cuts 18 gauge steel and plastics up to 3/32" thick. It also makes straight or curve cuts clean and smooth.

Aircraft Specialty Tools

Sioux Tools offers several specialized tools for the aircraft industry such as Skin Clamp Runners, which are available in pistol grip or our exclusive Z-handle design. Rivet Shavers come in both pistol grip and inline configurations, with speeds up to 21,000 rpm.

Clinch Nut Tools

As manufacturing trends continue to evolve manufacturers are finding more and more uses for thin wall assembly applications. Sioux Tools has a selection of Clinch Nut tools that handle these unique fasteners with precision and ease, and our Rapid Reverse feature makes them the best Clinch Nut tool on the market today.

Air Powered Saws

Sioux Tools offers an outstanding and powerful Reciprocating Saw, offering variable speed control for precise cutting action in any application.





ROUTERS

Performance:

Power: 1 hp (0.75 kW)
 Speed: 18,000 rpm – 25,000 rpm
 Collet Size: 1/4" (6 mm)

Features:

Lockoff Lever Throttle
 Front Exhaust
 Interchangeable Base
 Built-in Speed Control

1 hp (0.75 kW) Routers



Model Number	Collet Size	Free Speed	Weight		Height		Air Consumption	
		rpm	lb	kg	in	mm	scfm	l/s
Template Nose*								
SRT10S18N	1/4	18000	2.1	0.95	9.0	230	30	14
SRT10S18M6N	6 mm	18000	2.1	0.95	9.0	230	30	14
SRT10S25N	1/4	25000	2.1	0.95	9.0	230	30	14
SRT10S25M6N	6 mm	25000	2.1	0.95	9.0	230	30	14
3" Base								
SRT10S18B	1/4	18000	2.1	0.95	9.0	230	30	14
SRT10S18M6B	6 mm	18000	2.1	0.95	9.0	230	30	14
SRT10S18BB	1/4	18000	2.6	1.15	8.3	210	30	14
SRT10S25B	1/4	25000	2.1	0.95	9.0	230	30	14
SRT10S25M6B	6 mm	25000	2.1	0.95	9.0	230	30	14
SRT10S25BB	1/4	25000	2.6	1.15	8.3	210	30	14
Laminate Trimmer								
SRT10S18LT	1/4	18000	2.9	1.30	9.3	235	30	14
SRT10S25LT	1/4	25000	2.9	1.30	9.3	235	30	14

*Template guides must be ordered separately, page 82

General: Air Inlet Size: 1/4" NPT • Recommended Hose Size: 3/8" (10 mm)
 Performance rated @ 90 psig (6.2 bar) air pressure

Standard Equipment: Parts List • Safety and Instruction Manual
 Base/Head Assembly, Collet, Collet Wrenches

Accessories: Router Accessories, see pages 89 – 90

SRT10S25N



SRT10S25B



SRT10S25BB



SRT10S25LT



Performance:

Power: 1.5 hp (1.2 kW)
 Speed: 20,000 rpm
 Collet Size: 1/4" – 1/2"

Features:

Twist and Finger Throttle
 4" (102 mm) or 6" (152 mm)
 Diameter Base
 Side Exhaust

1.5 hp (1.2 kW) Routers

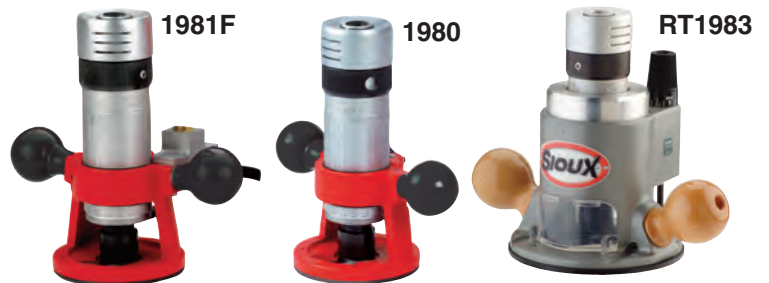

Model Number	Collet Size	Free Speed	Weight		Height		Base Diameter		Air Consumption	
		rpm	lb	kg	in	mm	in	mm	scfm	l/s
Finger Throttle										
1981F	1/2"	20000	6.0	2.7	9.8	248	4.0	102	38	18
Twist Throttle										
1980A	1/4"	20000	4.5	2.0	7.6	193	4.0	102	38	18
1980	3/8"	20000	4.5	2.0	7.6	193	4.0	102	38	18
RT1981	1/2"	20000	4.5	2.0	7.6	193	4.0	102	38	18
1982A	1/4"	20000	7.5	3.4	8.3	211	6.0	152	38	18
RT1982	3/8"	20000	7.5	3.4	8.3	211	6.0	152	38	18
RT1983	1/2"	20000	7.5	3.4	8.3	211	6.0	152	38	18

General: Air Inlet Size: 3/8" NPT • Recommended Hose Size: 3/8" (10 mm) • Performance rated @ 90 psig (6.2 bar) air pressure

Standard Equipment: Parts List • Safety and Instruction Manual • Base & Collet Wrenches

Accessories: Router Accessories, see pages 89 – 90



SAFETY PRECAUTION: Read and follow all safety and operating instructions.
WARNING: Face & eye protection must be worn while operating power tools, per ANSI B186.1

SPECIALTY

The Fastest Way Out of a Clinch

Sioux Tool's new rapid reverse Clinch Nut Tools are meeting the demand of today's manufacturing marketplace with versatility and simplicity. Clinch nuts, also known as captive nuts, provide a reliable means of securing assembly components in thin wall applications. These unique fasteners are inserted into predrilled holes in thin materials such as sheet metal, and with the aid of a Sioux Clinch Nut Tool, compress and expand to clamp the material. This process creates a strong, secure base with a male or female thread for assembling additional components.

Installing Clinch Nut Fasteners

When installing clinch nut fasteners, the key to achieving high productivity with accurate, repeatable results is matching the right tool and fastener to your application. The right combination of rundown speed and stall torque in conjunction with a quick reverse method for disengaging the tool, will provide the best results. The Sioux SCN series tools offer higher torque in a wide range of speeds so you can match the right tool to your application. Our powerful tools allow you to use faster rundown speeds while maintaining high torque output, plus our exclusive Rapid Reverse feature makes short work of direction changes ensuring fast disengagement from the fastener.

Reducing Physical Load

The ergonomic pistol housing with comfort rubber grip ensures operator comfort while maintaining superb balance and control. The powerful, precision motor ensures fast and consistent installation of fasteners in a variety of applications, and the wide selection of speeds and threads in both English and metric sizes make Sioux Tools your choice for all your clinch nut applications.

Clinch Nut Installation Procedure

Step 1 – Pre-drill hole for fastener.



Step 2 – Insert fastener.



Step 3 – Thread tool into fastener.



Step 4 – Run tool to collapse fastener.
Reverse tool to release.

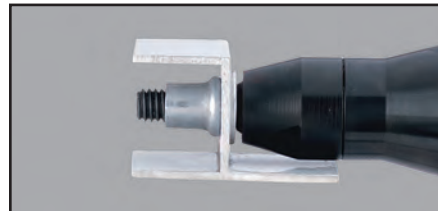

Step 5 – Assemble.

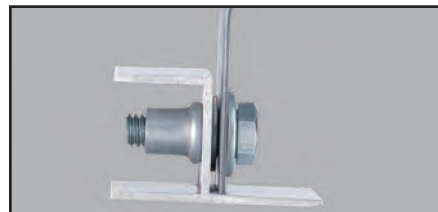

CLINCH NUT TOOLS

Performance:

Torque: 60 in. lb (6.5 Nm) – 400 in. lb (45 Nm)
 Speed: 300 rpm – 2,500 rpm

Features:

Reversible
 Pistol Grip

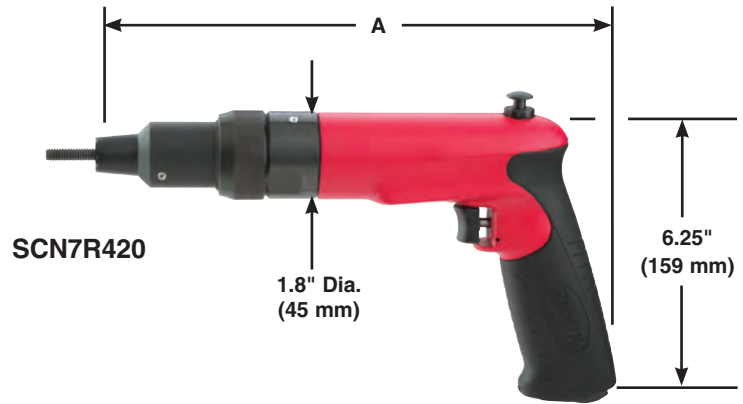

For ordering complete tools select the appropriate power unit from the power unit table below, then select required thread size from Clinch Nut or Stud Head Unit tables. Combine part numbers for complete tool e.g. 700 rpm + 1/4-20 serrated nose = SCN7R420.

1 hp (0.75 kW) Clinch Nut Power Unit



Model Number	Free Speed	Maximum Torque		Weight		"A" Dimension		Side To Center		Air Consumption		
	rpm	in lb	Nm	lb	kg	in	mm	in	mm	scfm	l/s	
Pistol Grip – Rapid Reverse – Power Unit Only Specifications												
SCN3R	300	400	45.2	3.2	1.5	11	279	0.9	20	30	14	
SCN5R	500	325	36.7	3.2	1.5	11	279	0.9	20	30	14	
SCN7R	700	220	24.8	3.2	1.5	11	279	0.9	20	30	14	
SCN12R	1200	145	16.4	3.2	1.5	11	279	0.9	20	30	14	
SCN20R	2000	80	9.0	2.8	1.3	10	254	0.9	20	30	14	
SCN25R	2500	60	6.5	2.8	1.3	10	254	0.9	20	30	14	

General: Air Inlet Size: 1/4" NPT • Recommended Hose Size: 3/8" (10 mm) • Performance rated @ 90 psig (6.2 bar) air pressure

Standard Equipment: Parts List • Safety and Instruction Manual • Comfort Grip

Accessories: Clinch Nut Accessories, see pages 89 – 90



Front End Attachments

Clinch Nut



Thread Size	Order Number Suffix	
	Serrated Nose	Smooth Nose
#4-40	440	440S
M3 x 0.5	M305	M305S
#6-32	632	632S
#8-32	832	832S
M4 x 0.7	M407	M407S
#10-24	1024	1024S
#10-32	1032	1032S
M5 x 0.8	M508	M508S
1/4-20	420	420S
M6 x 1.0	M610	M610S
5/16-18	518	518S
M8 x 1.25	M8125	M8125S
3/8-16	616	616S
M10 x 1.5	M1015	M1015S

Clinch Stud



Thread Size	Order Number Suffix	
	Serrated Nose	Smooth Nose
#4-40	440F	440SF
M3 x 0.5	M305F	M305SF
#6-32	632F	632SF
#8-32	832F	832SF
M4 x 0.7	M407F	M407SF
#10-24	1024F	1024SF
#10-32	1032F	1032SF
M5 x 0.8	M508F	M508SF
1/4-20	420F	420SF
M6 x 1.0	M610F	M610SF
5/16-18	518F	518SF
M8 x 1.25	M8125F	M8125SF
3/8-16	616F	616SF
M10 x 1.5	M1015F	M1015SF

Head unit assemblies can be ordered separately by adding the prefix SCN to the above part number (example 1/4-20 serrated nose = SCN-420).



SAFETY PRECAUTION: Read and follow all safety and operating instructions.
WARNING: Face & eye protection must be worn while operating power tools, per ANSI B186.1



TAPPERS

Performance:

Power: 1 hp (0.75 kW)
 Torque: 145 in. lb (16 Nm) – 400 in. lb (45 Nm)
 Speed: 300 rpm – 1,200 rpm

Features:

Pistol Grip Handle
 Rapid Reverse

Capacity:

1/4" in Steel
 5/16" in Aluminum



Tappers

Model Number	Chuck Capacity		Maximum Torque		Free Speed	Weight		Length		Air Consumption	
	in	mm	in lb	Nm	rpm	lb	kg	in	mm	scfm	l/s
1 hp (0.75 kW) – Pistol Grip – Trigger Start											
STP10P3C20	#10-5/16	5-8	400	45	300	2.9	1.3	7.3	185	30	14
STP10P3C32	1/4-1/2	6-13	400	45	300	2.9	1.3	7.3	185	30	14
1 hp (0.75 kW) – Inline – B12 Taper Spindle											
STP10S12B12			145	16	1200	2.5	1.2	9.5	240	30	14
STP10S7B12			220	25	700	2.5	1.2	9.5	240	30	14
STP10S5B12			325	37	500	2.5	1.2	9.5	240	30	14
STP10S3B12			400	45	300	2.5	1.2	9.5	240	30	14

General: Air Inlet Size: 1/4" NPT • Recommended Hose Size: 3/8" (10 mm) • Performance rated @ 90 psig (6.2 bar) air pressure

Standard Equipment: Parts List • Safety and Instruction Manual • Comfort Grip • Tapping Chuck (model STP10P3C series)

Accessories: Tapper Accessories, see pages 89 – 90



SKIN CLAMP RUNNERS



SSR4P26



2S2300SR



SSR6P25

Performance:

Speed: 2,200 rpm - 2,500 rpm

Features:

Pistol Grip and Z-Handle
 1/2-12 Point Internal, 9/16-6 Point External Hex

Skin Clamp Runners



Model Number	Fastener Type	Free Speed	Weight		Length		Side to Center		Air Consumption		
		rpm	lb	kg	in	mm	in	mm	scfm	l/s	
0.24 hp (0.18 kW) – Pistol Grip											
SSR4P26	Cylindrical	2600	1.7	0.7	7.0	178	0.7	17	20	10	
0.33 hp (0.25 kW) – Z-Handle											
2S2300SR	Hex	2200	2.6	1.2	5.7	145	0.9	23	16	8	
0.40 hp (0.30 kW) – Pistol Grip											
SSR6P25	Hex	2500	2.7	1.2	9.2	234	0.9	23	30	14	

General: Air Inlet Size: 1/4" NPT • Recommended Hose Size: 3/8" (10 mm) • Performance rated @ 90 psig (6.2 bar) air pressure

Standard Equipment: Parts List • Safety and Instruction Manual • Comfort Grip (Pistol Grip models)

Accessories: Skin Clamp Runner Accessories, see pages 89 – 90



SAFETY PRECAUTION: Read and follow all safety and operating instructions.
WARNING: Face & eye protection must be worn while operating power tools, per ANSI B186.1

RIVET SHAVERS



SRS6P21-8



SRS10P21-8



SRS10S21-8

Performance:

Power: 0.6 hp (0.45 kW) - 1 hp (0.75 kW)
Speed: 21,000 rpm

Features:

0.0005" Locking Depth Increments
Spindle Lock
SRS6P E-Z Set and Lock
SRS10P Locking Collar with Reference Marks

Rivet Shavers



Model Number	Cutter Diameter		Free Speed rpm	Weight		Length		Side to Center		Air Consumption	
	in	mm		lb	kg	in	mm	in	mm	scfm	l/s
0.6 hp (0.45 kW) – Pistol Grip – 1/4"-28 Internal Thread											
SRS6P21-5	5/16	8	21000	2.0	0.9	6.5	165	0.8	21	25	12
SRS6P21-6	3/8	10	21000	2.0	0.9	6.5	165	0.8	21	25	12
SRS6P21-7	7/16	11	21000	2.0	0.9	6.5	165	0.8	21	25	12
SRS6P21-8	1/2	13	21000	2.0	0.9	6.5	165	0.8	21	25	12
SRS6P21-9	9/16	14	21000	2.0	0.9	6.5	165	0.8	21	25	12
SRS6P21-10	5/8	16	21000	2.0	0.9	6.5	165	0.8	21	25	12
SRS6P21-9W	9/16	14	21000	2.0	0.9	6.5	165	0.8	21	25	12
1 hp (0.75 kW) – Pistol Grip – 1/4"-28 Internal Thread											
SRS10P21-5	5/16	8	21000	2.7	1.2	8.0	205	0.9	23	25	12
SRS10P21-6	3/8	10	21000	2.7	1.2	8.0	205	0.9	23	25	12
SRS10P21-7	7/16	11	21000	2.7	1.2	8.0	205	0.9	23	25	12
SRS10P21-8	1/2	13	21000	2.7	1.2	8.0	205	0.9	23	25	12
SRS10P21-9	9/16	14	21000	2.7	1.2	8.0	205	0.9	23	25	12
SRS10P21-10	5/8	16	21000	2.7	1.2	8.0	205	0.9	23	25	12
1 hp (0.75 kW) – Inline – 1/4"-28 Internal Thread											
SRS10S21-8	1/2	13	21000	2.5	1.1	10.0	255	0.9	23	30	14

General: Air Inlet Size: 1/4" NPT • Recommended Hose Size: 3/8" (10 mm) • Performance rated @ 90 psig (6.2 bar) air pressure
Standard Equipment: Parts List • Safety and Instruction Manual • Skirt • Comfort Grip (Pistol Grip models)
 Stabilizer (SRS10P) • Cutters Not Included
Accessories: Rivet Shaver Accessories, see pages 89 – 90

RIVET SHAVER SKIRTS AND STABILIZER

Part Number	Cutter Diameter	
	in	mm
2925-5	5/16	8
2925-6	3/8	10
2925-7	7/16	11
2925-8B	1/2	13
2925-9	9/16	14
2925-9W	9/16	14
2925-10	5/8	16

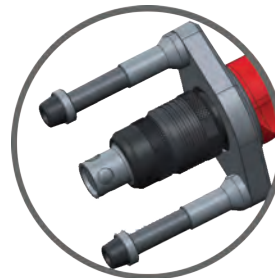

Part Number	For Use On
74274A	SRS6P21 series



SAFETY PRECAUTION: Read and follow all safety and operating instructions.
WARNING: Face & eye protection must be worn while operating power tools, per ANSI B186.1

RECIPROCATING SAWS

Performance:

Power: 1 hp (0.75 kW)
 Strokes per Minute: 1,800
 Stroke Length: 0.6" (15 mm)

Features:

Lockoff Trigger Start
 Variable Speed
 Swivel Air Inlet



1300

Reciprocating Saw

Model Number	Stroke Length		Strokes per Minute	Power		Weight		Length		Air Consumption	
	in	mm		hp	kW	lb	kg	in	mm	scfm	l/s
1300	0.6	15	1800	1	0.7	7.8	3.5	17.2	437	35	17

General: Air Inlet Size: 1/4" NPT • Recommended Hose Size: 3/8" (10 mm) • Performance rated @ 90 psig (6.2 bar) air pressure
Standard Equipment: Parts List • Safety and Instruction Manual • Swivel Air Inlet • 2 Blades • Protective Boot
Accessories: Reciprocating Saw Accessories, see pages 89 – 90

Performance:

Strokes per Minute: 10,000
 Stroke Length: 0.375" (10 mm)
 Cuts up to 1/8" (3 mm) mild steel

Features:

Lock-off lever start
 Low vibration
 360° Adjustable Exhaust Deflector
 Dual chuck accepts: standard air saw blades AND reciprocating saw blades, up to 0.040" thick



RS10K

Reciprocating Saw

Model Number	Stroke Length		Strokes per Minute	Weight		Length		Air Consumption	
	in	mm		lb	kg	in	mm	scfm	l/s
RS10K	0.375	10	10000	1.53	0.69	9.4	240	8.4	4.0

General: Air Inlet Size: 1/4" NPT • Recommended Hose Size: 3/8" (10 mm) • Performance rated @ 90 psig (6.2 bar) air pressure
Standard Equipment: Parts List • Safety and Instruction Manual • Swivel Air Inlet • Protective Boot
Accessories: Reciprocating Saw Accessories, see pages 89 – 90

Reciprocating Saw Blades



1815



1816

Reciprocating Saw Blades

Part Number	Length		Teeth Per Inch
	in	mm	
For Use on Model 1300 & RS10K			
1815B	6	150	10
1810	6	150	14
1813	4	100	14
1811	6	150	18
1812	4	100	18
1814	6	150	24
1816	6	150	6
1819	12	300	6

Packaged in Cartons of 5



1823

Air Saw Blades

Part Number	Length		Teeth Per Inch
	in	mm	
For Use on Model RS10K			
1823	3.7	94	18
1824B	3.7	94	24
1825	3.7	94	32



SAFETY PRECAUTION: Read and follow all safety and operating instructions.
WARNING: Face & eye protection must be worn while operating power tools, per ANSI B186.1



NIBBLER

Performance:

Power: 1 hp (0.75 kW)
Capacity: 18 Gauge Cold Rolled Steel



SNH10S18

Nibbler

Model Number	Capacity (Cold Rolled Steel)	Power		Weight		Length		Side to Center		Air Consumption	
	in	hp	kW	lb	kg	in	mm	in	mm	scfm	l/s
Nibbler											
SNH10S18 ¹	18 Ga	1	0.75	2.65	1.2	8.5	215	0.9	32	30	14

¹ Not CE Certified

General:

Air Inlet Size: 1/4" NPT • Recommended Hose Size: 3/8" (10 mm) • Performance rated @ 90 psig (6.2 bar) air pressure

Standard Equipment:

Parts List • Safety and Instruction Manual

Accessories:

Nibbler Accessories, see pages 89 – 90



SHEARS

Performance:

Power: 1 hp (0.75 kW)
Capacity: 18 Gauge Cold Rolled Steel



SSH10S18



SSH10P18

Shears

Model Number	Capacity (Cold Rolled Steel)	Power		Weight		Length		Side to Center		Air Consumption	
	in	hp	kW	lb	kg	in	mm	in	mm	scfm	l/s
Shears											
SSH10S18 ¹	18 Ga	1	0.75	2.75	1.25	11.0	280	0.9	32	30	14
SSH10P18	18 Ga.	1	0.75	2.9	1.3	10.0	255	0.9	22	30	14

¹ Not CE Certified

General:

Air Inlet Size: 1/4" NPT • Recommended Hose Size: 3/8" (10 mm) • Performance rated @ 90 psig (6.2 bar) air pressure

Standard Equipment:

Parts List • Safety and Instruction Manual • Comfort Grip (SSH10P18)

Accessories:

Shears Accessories, see pages 89 – 90



SAFETY PRECAUTION: Read and follow all safety and operating instructions.
WARNING: Face & eye protection must be worn while operating power tools, per ANSI B186.1

SPECIALTY

Compression Riveters

Principles of Operation

Air powered compression riveters deliver a squeezing action, which drives the rivet by “flowing” the rivet metal with compressed forces. Squeezing action is obtained by coupling an air cylinder and piston to a wedge or cam, thus multiplying the original force to extreme ratios. High compressive forces are obtained from a relatively compact unit having small diameter cylinders and using very little compressed air.

The advantage of squeeze riveting is simple sounds of air exhaust and forward piston movement developing tremendous pressures being exerted at the work point.

Optimum control may be obtained in compression riveting. The rivet head is formed by a steady, uniform squeeze action. The set plunger and dolly are an integral part of the squeezer itself.

Length of the return stroke may be adjusted that the plunger itself does not have to travel its full length.

Consistently applied pressure makes for a better appearance of the finished product as well as giving the ultimate in structural efficiency.

Classification of Squeezers:

Alligator: The squeezing action of the jaws are similar to the movement of an Alligator's jaws.

'C' Type: The rivet is squeezed between the two ends of the 'C'.

Type of Rivet:

Rivet material.

Rivet body diameter.

Rivet length before and after compression.

Force required to compress rivet.

Riveter Selection Guide:

What material is the rivet made from?

What size is the rivet?

What is the form of the head?

What components are being assembled?

Are there any clearance problems?

Is Alligator or 'C' type yoke required?

How is the application being done now?

Are there any special considerations?

COMPRESSION RIVETERS

For maximum power the combined length of the two rivet sets must be of the correct length.

Determine the correct lengths as follows:

1) When two cupped rivet sets are used:

The length of the body dimensions of the two rivet sets (A1, A2) should equal the closed height dimension of the yoke (H) minus the total thickness of material being riveted together.

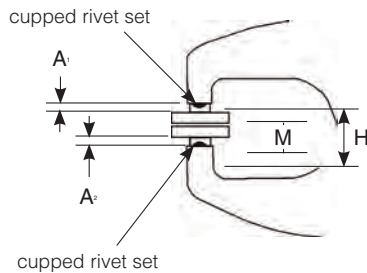

$$A_1 + A_2 = H - M$$

2) When one cupped set and one flush set are used:

The length of the body dimensions of the two rivet sets (A1, A2) should equal the closed height dimension of the yoke H minus the total thickness of material being riveted (M) and the height of the finished rivet head (Z) compressed by the flush set (A).

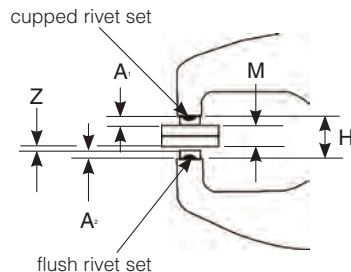

$$A_1 + A_2 = H - M - Z$$

3) When two flush sets are used:

The length of the body dimensions of the two rivet sets (A1, A2) should equal the closed height dimension of the yoke (H) minus the overall length of the rivet (M) after it is compressed.

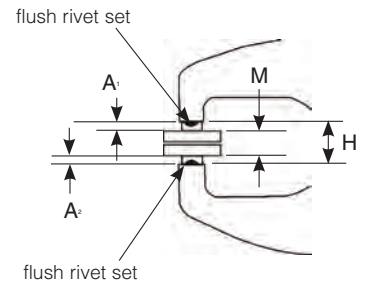

$$A_1 + A_2 = H - L$$

If necessary, select rivet sets a little short and shim to the correct length using spacer shims.

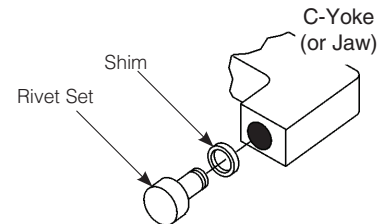

COMPRESSION RIVETERS

Features:

- Single, Tandem, and Triple Cylinder Options
- Riveting Capacity:
 - 1/8" (3 mm) (Single Cylinder)
 - 3/16" (5 mm) (Tandem Cylinder)
 - 1/4" (6 mm) (Triple Cylinder)
- Safety Throttle



Compression Riveters

Model Number	Rivet Set Shank Diameter		Cap Cold Rivet Diameter			Standard Alligator Yoke Dimension				Max Force at 90 psi		Moving Jaw				Net Weight w/ Yoke		Overall Length		
			Steel		Alum		Reach		Closed Ht			Max Travel		Stroke at Max Force						
	in	mm	in	mm	in	mm	in	mm	in	mm	in	mm	in	mm	in	mm	lb	kg	in	mm
CR-1 – Single Cylinder																				
SZE5000	NA	NA	3/32	2	1/8	3	NA	NA	NA	NA	3000	13.4	5/8	16	final 1/16	2	2-1/4	1.0	7-11/16	195
SZE5015	3/16	5	3/32	2	1/8	3	1-1/2	38	7/8	22	3000	13.4	5/8	16	final 1/16	2	3.75	1.7	9-3/16	233
SZE5022	3/16	5	3/32	2	3/32	2	2-1/4	57	7/8	22	2200	9.8	7/8	22	final 3/32	2	4.25	1.9	10-1/8	257
SZE5030	3/16	5	3/32	2	3/32	2	3	76	7/8	22	1800	8.0	1-1/4	32	final 1/8	3	4.75	2.2	10-7/8	276
CR-1 – Tandem Cylinder																				
SZE7000	NA	NA	5/32	4	3/16	5	NA	NA	NA	NA	6000	26.7	5/8	16	final 1/16	2	4.0	1.8	10-1/2	267
SZE7015	3/16	5	5/32	4	3/16	5	1-1/2	38	7/8	22	6000	26.7	5/8	16	final 1/16	2	5.5	2.5	12	305
SZE7022	3/16	5	1/8	3	5/32	4	2-1/4	57	7/8	22	4300	19.1	7/8	22	final 3/32	2	6.0	2.7	13	330
SZE7030	3/16	5	3/32	2	1/8	3	3	76	7/8	22	3400	15.1	1-1/4	32	final 1/8	3	6.25	2.8	13.75	349
CR-1 – Triple Cylinder																				
SZE9000	NA	NA	3/16	5	1/4	6	NA	NA	NA	NA	9000	40.1	5/8	16	final 1/16	2	5.5	2.5	14.5	368
SZE9015	3/16	5	3/16	5	1/4	6	1-1/2	38	7/8	22	9000	40.1	5/8	16	final 1/16	2	7.0	3.2	16	406
SZE9022	3/16	5	5/32	4	3/16	5	2-1/4	57	7/8	22	7000	31.2	7/8	22	final 3/32	2	7.5	93.4	16.75	426
SZE9030	3/16	5	5/32	4	3/16	5	3	76	7/8	22	5200	23.1	1-1/4	32	final 1/8	3	8.0	3.6	17.5	445

General:
 Air Inlet Size: 1/4" NPT • Recommended Hose Size: 3/8" (10 mm) • Performance rated @ 90 psig (6.2 bar) air pressure

Standard Equipment:
 Parts List • Safety and Instruction Manual • Safety throttle action

Alligator Yoke Nomenclature

- A Reach
- B Closed Height
- C Total
- E Gap
- H Lowest Offset
- N Depth from centerline to Stationary Jaw Gap
- P Depth from centerline to Stationary Jaw set hole surface

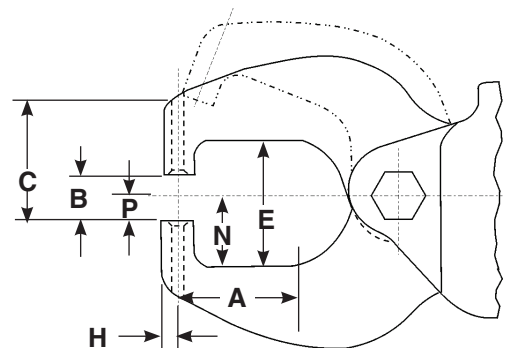

A		B		C		E		H		N		P	
in	mm	in	mm	in	mm	in	mm	in	mm	in	mm	in	mm
1-1/2	38	7/8	22	1-1/2	38	1-5/8	41	7/32	6	1.0	1	5/8	16
2-1/4	57	7/8	22	1-7/8	48	2-1/8	54	7/32	6	1-1/4	32	5/8	16
3	76	7/8	22	2-1/8	54	2-1/8	54	7/32	6	1-1/4	32	5/8	16

COMPRESSION RIVETERS

Features:

Single, Tandem, and Triple Cylinder Options
 Riveting Capacity:
 1/8" (3 mm) (Single Cylinder)
 3/16" (5 mm) (Tandem Cylinder)
 1/4" (6 mm) (Triple Cylinder)
 Safety Throttle



SZE3015



SZE6015



SZE8015

Compression Riveters

Model Number	Rivet Set Shank Diameter		Cap Cold Rivet Diameter				Standard "C" Yoke Dimension				Closed Height		Max Travel		Max Force at 90 psi		Stroke at Max Force		Net Weight w/ Yoke		Overall Length	
			Steel		Alum		Reach		Gap													
	in	mm	in	mm	in	mm	in	mm	in	mm	in	mm	in	mm	lb	kN	in	mm	lb	kg	in	mm
CR-1 – Single Cylinder																						
SZE3000	N/A	N/A	3/32	2	1/8	3	N/A	N/A	N/A	N/A	N/A	N/A	9/16	14	3000	13.4	f-1/16	2	3-1/2	1.6	8-1/2	216
SZE3015	3/16	5	3/32	2	1/8	3	1-1/2	38	1-1/4	32	11/16	78	9/16	14	3000	13.4	f-1/16	2	4-1/2	2	10-1/4	262
CR-1 – Tandem Cylinder																						
SZE6000	N/A	N/A	5/32	4	3/16	5	N/A	N/A	N/A	N/A	N/A	N/A	9/16	14	6000	26.7	f-1/16	2	4-1/2	2	11-1/4	287
SZE6015	3/16	5	5/32	4	3/16	5	1-1/2	38	1-1/4	32	11/16	78	9/16	14	6000	26.7	f-1/16	2	5-1/2	2.5	14	356
CR-1 – Triple Cylinder																						
SZE8000	N/A	N/A	5/32	4	1/4	6	N/A	N/A	N/A	N/A	N/A	N/A	9/16	14	9000	40.1	f-1/16	2	7-1/2	3.4	16	406
SZE8015	3/16	5	3/16	5	1/4	6	1-1/2	38	1-1/4	32	11/16	78	9/16	14	9000	40.1	f-1/16	2	8-1/2	3.9	18-3/4	476

Due to a variety of jobs and applications, Squeeze Riveters are not supplied with rivet sets. Please contact Sioux Tools, Inc. or your local distributor for rivet set information.

General:

Air Inlet Size: 1/4" NPT • Recommended Hose Size: 3/8" (10 mm) • Performance rated @ 90 psig (6.2 bar) air pressure

Standard Equipment:

Parts List • Safety and Instruction Manual • Safety throttle action

C-Yoke Nomenclature

- A** Reach
- B** Gap
- C** Height from yoke hole to center to top of yoke gap
- D** Bottom set hole diameter CR-1 or CR-2
- E** Top set hole diameter CR-1 or CR-2
- F** Width of yoke set hole center to top of yoke
- G** Thickness of yoke
- H** Height of yoke from bolt hole center to top of yoke
- I** Radius from set hole center

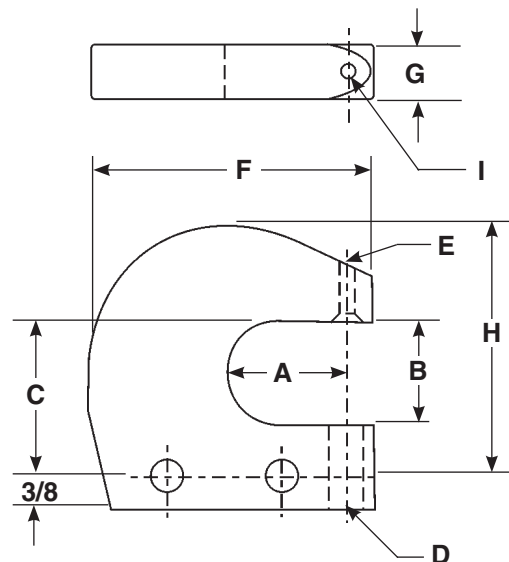

A		B		C		D		E		F		G		H		I	
in	mm	in	mm	in	mm	in	mm	in	mm	in	mm	in	mm	in	mm	in	mm
1-1/2	38	1-1/4	32	1-7/8	48	3/8	10	3/16	5	2-7/8	73	9/16	14	3	76	1/4	6
						7/16	11	1/4	6								



SAFETY PRECAUTION: Read and follow all safety and operating instructions.
WARNING: Face & eye protection must be worn while operating power tools, per ANSI B186.1

Rivet Shaver Skirts



2925-8B

Part Number	Cutter Diameter	
	in	mm
2925-5	5/16	8
2925-6	3/8	10
2925-7	7/16	11
2925-8B	1/2	13
2925-9	9/16	14
2925-9W	9/16	14
2925-10	5/8	16

Stabilizer

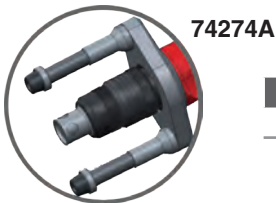

74274A

Part Number	For Use On
74274A	SRS6P21 series

Collets



44440



21126B

Collet Type	Part Number	Capacity	For Use On
Sioux	44440	1/4"	1971HP series
Sioux	66038	6 mm	1971HP series
100 Series	21126B	1/4"	1980A, 1982A, RT1985
100 Series	21125	3/8"	1980, RT1982, 1985A
100 Series	21124	1/2"	1981F, RT1981, RT1983, 1985-1/2



21095

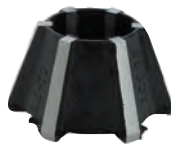

21139

Collet Type	Collets
21095	#10 - 5/16"
21139	1/4" - 1/2"

Signature Series Support Handle

Part No. 77067A

For use on 10P and 10S tools.



Collet Chuck Assemblies

Sioux Style Collets

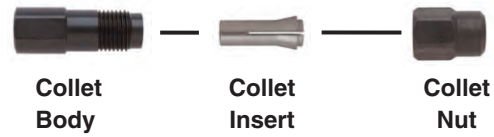

Collet Chuck Assemblies	Sioux Collet Chuck				
	1/8"	3 mm	3/16"	1/4"	6 mm
Chuck Assembly	43342	68617	43341	43340	68618
Collet Body	21096	21096	21096	21096	21096
Collet Insert	44522	66037	44523	44440	66038
Collet Nose	N/A	N/A	N/A	N/A	N/A
Collet Nut	21097	21097	21097	21097	21097

200 Series Heavy Duty Double Tapered Collet



Part Number	Description
74071	Collet Nut
74072	Collet (1/8")
74073	Collet (3/16")
74074	Collet (1/4")
77400	Collet (1/4") Heavy Duty
68030	Collet (3/8")
74075	Collet (3 mm)
74076	Collet (6 mm)
68056	Collet (8 mm)
77057	Collet Body SDG Series
74070	Collet Body (1 hp)
74070KIT	Includes 74070, 74071, 74074

300 Series Heavy Duty Double Tapered Collet



Part Number	Description
74128	Collet Nut
74124	Collet (3/32")
74121	Collet (1/8")
74120	Collet (1/4")
74122	Collet (3 mm)
74123	Collet (6 mm)
77505	Collet Body SAS Series
74125	Collet Body SDG Series



SAFETY PRECAUTION: Read and follow all safety and operating instructions. **WARNING:** Face & eye protection must be worn while operating power tools, per ANSI B186.1

Router Base Assembly



Part Number	Used On
1992	SRT10S25BB
1993	1971HP / SRT10S25BB
1994	1971HPC / SRT10S25BB

Laminate Base Trimmer

Part No. 1991

For use on SRT10S25LT series routers



Reciprocating Saw Blades

Packaged in Cartons of 5



1815



1816

Part Number	Length		Teeth Per Inch
	in	mm	
For Use on Model 1300 & RS10K			
1815B	6	150	10
1810	6	150	14
1813	4	100	14
1811	6	150	18
1812	4	100	18
1814	6	150	24
1816	6	150	6
1819	12	300	6



1823

Part Number	Length		Teeth Per Inch
	in	mm	
For Use on Model RS10K			
1823	3.7	94	18
1824B	3.7	94	24
1825	3.7	94	32

Template Guide Chart

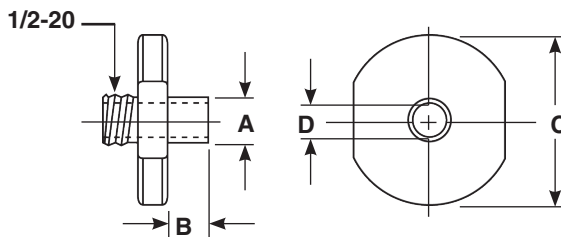

Part Number	Dimensions in Inches			
	A Pilot OD	B Pilot Length	C Flange OD	D Pilot ID
68613-12	3/8	1/4	3/4	9/32
68613-14	3/8	3/8	3/4	9/32
68613-16	3/8	1/2	3/4	9/32
68613-22	3/8	1/8	1-1/2	9/32
68613-24	3/8	1/4	1-1/2	9/32
68613-26	3/8	3/8	1-1/2	9/32
68613-40	7/16	1/4	3/4	21/64
68613-42	7/16	3/8	3/4	21/64
68613-44	7/16	1/2	1-1/2	21/64
68613-48	7/16	1/4	1-1/2	21/64
68613-50	7/16	3/8	1-1/2	21/64
68613-52	7/16	1/2	1-1/2	21/64
68613-62	1/2	1/4	1-1/2	11/32
68613-64	1/2	3/8	1-1/2	11/32
68613-66	1/2	1/2	1-1/2	11/32
68613-72	1/2	1/2	2-1/2	11/32
98613-76	1/2	1.0	3/4	5/16
98613-88	5/8	1.0	3/4	5/16



SAFETY PRECAUTION: Read and follow all safety and operating instructions.
WARNING: Face & eye protection must be worn while operating power tools, per ANSI B186.1

Filter, Regulator, Lubricator Assembly

NEW

Filter

Regulator

Lubricator

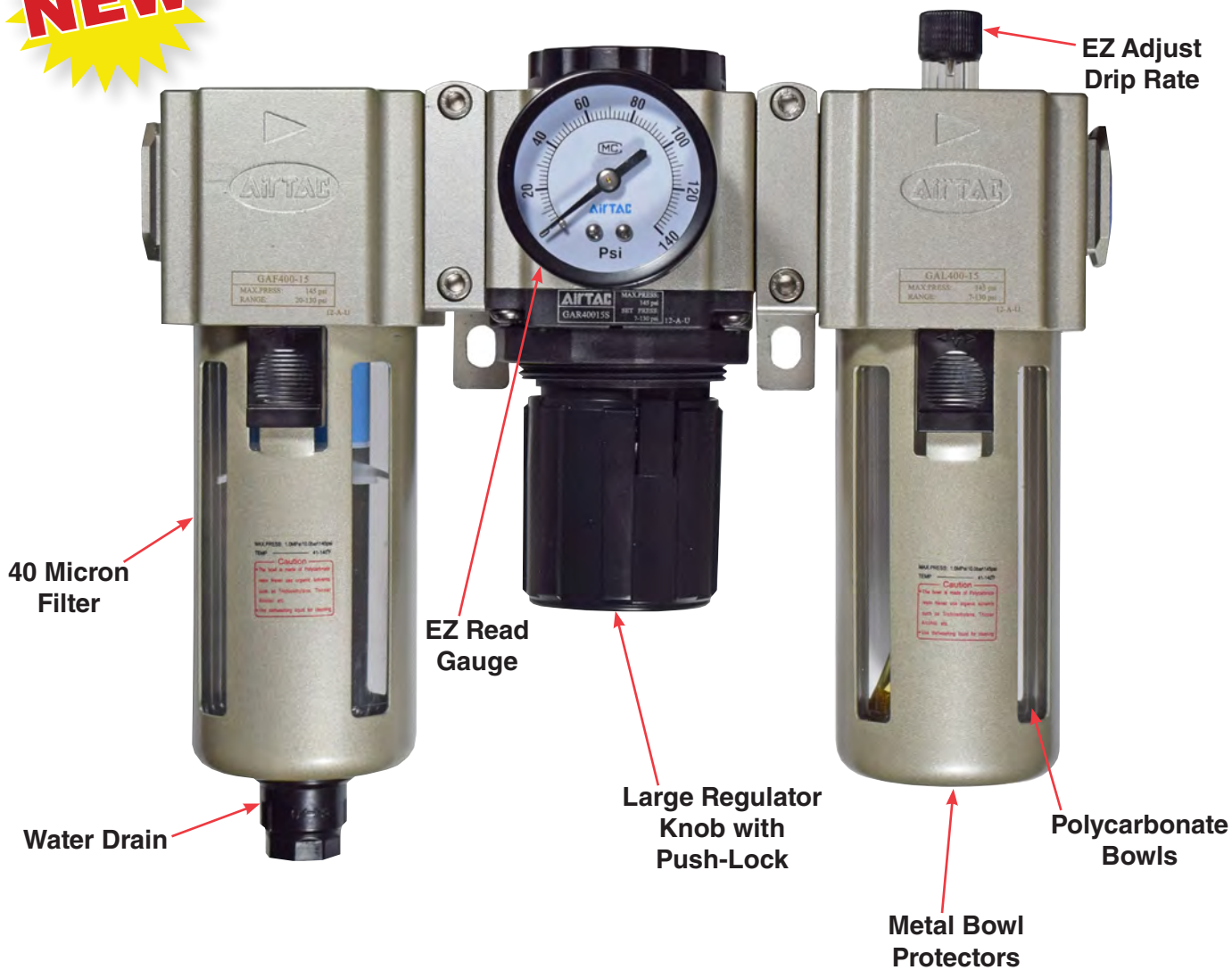

Filter, Regulator, Lubricator Assembly



Part Number	Inlet & Outlet	Height		Width		Depth		Bracket Spacing	
		in	mm	in	mm	in	mm	in	mm
1670	1/2" NPT	8.9	227	9.8	248	3.9	100	3.3	84



SAFETY PRECAUTION: Read and follow all safety and operating instructions.
WARNING: Face & eye protection must be worn while operating power tools, per ANSI B186.1

Air Regulator

Part No. 1335B

- 1/4" NPT Male/Female
- Mounts inline with air inlet
- Allows fine adjustment of air flow



Hi-Capacity Quick Change Couplers

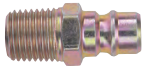

1316



1391



1395

Part Number	Description	Thread
1316	Male Coupler Nipple	1/4" NPT
1317	Male Coupler Nipple	3/8" NPT
1318	Male Coupler Nipple	1/2" NPT
1391B	Quick Change Coupler	1/4" NPT
1392B	Quick Change Coupler	3/8" NPT
1393	Quick Change Coupler	1/2" NPT
1395	Female Coupler Nipple	1/4" NPT
1396	Female Coupler Nipple	3/8" NPT

Nylon Recoil Air Hose



1326

Part Number	ID		Length		Fittings
	in	mm	ft	m	
1326B	1/4	6	25	7.6	1/4" NPT
1327B	3/8	10	25	7.6	1/4" NPT

Sioux Swivel

Allows the air hose to rotate 360° on 2 axes.



1338-25



1338FC-25

Part Number	Description
1338-25	1/4" non-regulated air swivel connector with safety pin
1338-38	3/8" non-regulated air swivel connector with safety pin
1338-50	1/2" non-regulated air swivel connector with safety pin
1338FC-25	1/4" regulated air swivel connector with safety pin

Balancers



2300-4

Part Number	Capacity		Cable Length	
	lb	kg	ft	m
2300-4	2 - 4	0.9 - 1.8	6.7	2
2300-6	4 - 6	1.8 - 2.7	6.7	2
2300-8	6 - 8	2.7 - 3.6	6.7	2

Grease Guns

Part No. 439

Use with impact wrenches and multi-assembly angle tools. For use with 4 oz grease tubes.



Part No. 442

Use with impact wrenches and multi-assembly angle tools. Fill with grease of choice



Grease Nozzle Adapter

Part No. 469A

Fits standard grease guns



Grease

Part Number	Description
289A	4 Ounces
289A-1	2 Pounds
289A-2	6 Pounds
1198	6 Ounces
1198-1B	2 Pounds
1198-2B	6 Pounds
1232A-04	4 Ounces
1232A-1	1 Quart

Air Motor Oil For Air Tools

Part No. 288

1/2 Pint

Part No. 288-1

1 Quart

Part No. 288-2

2 Liter



Service

Factory Authorized Service

Sioux Tools has Authorized Service Distributors conveniently located throughout the U.S., Canada and internationally to provide you with service virtually anywhere, anytime. Each is staffed with professional tool repair technicians who know Sioux tools, inside and out, and are able to provide complete and comprehensive repairs.

Each location features the newest in testing and inspection equipment to ensure your tool is repaired and serviced properly...the first time. Every tool that is serviced or repaired is calibrated and tested to the latest standards guaranteeing you the best performance possible.

See inside back cover for a complete listing of Authorized Service Distributors.

Training

Committed to your Success

To ensure your personnel are knowledgeable about not only Sioux products, but all air tools and products, Sioux Tools conducts training seminars that cover all aspects of the tools we sell. We offer introductory training seminars to help you understand our entire line of tools and their basic operation. Advanced training is tailored to individual needs to help build the skill of an experienced student. In addition, hands-on training is available with particular focus on troubleshooting and repairing.

For additional information on Sioux Tools training seminars, please contact your Sioux Tools Sales Representative.



Our 168,000 ft² facility in Murphy, North Carolina employs 300 associates. Each tool is designed and manufactured right here, with a distribution center that ships daily around the globe.



U.S. Independent Service Centers

ALABAMA

Birmingham

Motion Industries
824 North 31st St.
35203
205-251-7522

Dothan

Brackin Wholesale Coatings
725 South Oates St.
36301
334-793-4330

Winfield

McCaleb Tool Supply
710 Hwy 43 South
35594
205-487-2222

ARIZONA

Phoenix

Glenn's Tool Service
2149 East Indian School Rd.
85016
602-264-6203

ARKANSAS

Hot Springs

Arkansas Welding, Inc.
230 Valley St.
71901
501-321-9922

CALIFORNIA

Buena Park

Three Day Tool, Inc.
6767 8th St.
90620
714-521-9180

Rancho Dominguez

U.S. Air Tool Company
1219 W. Mahalo Pl.
90220
310-632-5400

Sonoma

Fastening Systems International
1206 E. MacArthur St.
95476
800-344-2393

FLORIDA

Doral

Air/Electric Tool & Equipment
7840 Nw 58th St.
33166
305-593-5040

Orlando

Air Centers of FL
7830 Kingspointe Parkway
32819
407-677-4200

Port Charlotte

Tropical Construction Supply
18412 Paulson Dr.
33954
941-743-5863

Spring Hill

R & R Tool Repair, Inc.
13591 Linden Dr.
34609
352-263-3587

Tampa

Compressed Air Systems, Inc.
9303 Stannum St.
33619
800-626-8177

GEORGIA

Atlanta

Fastenal
6215 Fulton Industrial Blvd.
30336
404-346-1026

Snellville

Kentec Inc.
3250 Centerville Hwy.
30039
770-985-1907

IOWA

Bloomfield

Gingerich Logging & Supply
16700 Jade Ave.
52537
641-722-3414

DesMoines

Peerless Supply Inc.
1701 Guthrie Ave.
50316
515-265-9905

Sioux City

The New Sioux City Iron Co.
310 South Floyd Blvd.
51101
712-255-7696

ILLINOIS

Machesney Park

Engman-Taylor Co Inc.
7980 Burden Rd.
61115
800-236-7282

INDIANA

Bristol

Tool Shed
220 E Vistula St.
46507
574-848-7815

Evansville

Lensing Tool & Supply
306 No 7th Ave.
47730
812-425-9049

Ferdinand

Superb Tooling, Inc.
250 Scenic Industrial Dr.
47532
812-367-2102

Indianapolis

Alcorn Industrial Inc.
5412 Rock Hampton Court
46268
317-872-6772

Indianapolis

Fastenal
3939 W 56th St.
46254
317-472-4341

Indianapolis

Vamaco Tool & Equipment Co.
6718 East 38th St.
46226
317-632-2208

KANSAS

Edwardsville

Fastenal
9911 Woodend Rd.
66111
913-422-6440

Shawnee

Clark's Tool Repair
6217 Goddard St.
66203
913-268-1271

KENTUCKY

Louisville

Rhino Assembly Service Center
3600 Chamberlin Ln., Suite 618
40214
502-753-0602

LOUISIANA

Harahan

ATR, LLC
629 S. Al Davis Rd.
70123
504-739-9481

New Orleans

Beerman Precision Inc.
4206 Howard Ave.
70125
504-486-9391

MARYLAND

Cockeysville

Air Power-Baltimore
243 Cockeysville Rd.
21030
410-785-5790

MASSACHUSETTS

Everett

Panda Electrical Service
165 Main St.
02149
617-389-1442

MINNESOTA

Bloomington

Mars Supply
215 E. 78th St.
55420
952-884-9388
800-862-6093

Duluth

Mars Supply
4319 W. 1st St.
55807
218-628-0303

Little Falls

Central McGowan
16444 11th St. NE
56345
320-632-9218

Minneapolis

Deko Factory Service
3048 Bloomington Ave So
55407
612-721-6651

Winona

Fastenal
2003 Theurer Blvd.
55987
507-313-7527

MISSOURI

St. Louis

John Henry Foster
4700 LeBourget Dr.
63134
314-427-0600

Fenton

Productive Tool Products, Inc.
1075 Headquarters Park Dr.
63026
636-305-1200

Maryland Heights

Logan Gresham, Ltd
2320 Mill Park Dr.
63043
314-521-2400

MISSISSIPPI

Tupelo

Compressors & Tools Inc.
105 Old Runway Rd.
38801
662-844-7023

NORTH CAROLINA

Greensboro

Carolina Tool Sales And Repair, Inc.
807 Huffman St.
27405
336-275-6124

High Point

Air Power, Inc. (NC)
1430 Trinity Ave.
27260
336-886-5081

High Point

Fastenal
4110 Premier Dr.
Suite 102
27265
336-888-3013

High Point

High Point Pneumatics Inc.
2430 English Rd.
27262
336-889-8416

NEBRASKA

Omaha

JDC Tool & Repair
6263 Abbott Dr.
68110
402-455-8000

U.S. Independent Service Centers

NEW YORK

Syracuse

Ace Hydraulic & Pneumatic
6720 Vip Parkway
13211
315-454-8989

OHIO

Apple Creek

Air Works
10680 Dover Rd.
44606
330-698-0388

Cleveland

Industrial Pneumatic
1715 Brookpark Rd.
44109
216-398-7550

Columbus

Mitchell-Mckinney Supply Co.
610 Greenlawn Ave.
43223
614-444-6732

Richfield

Ohio Tool Systems
3863 Congress Parkway
44286
330-659-4181

Youngstown

Power Tool & Supply Co.
3699 Leharps Rd.
44515
330-792-1487

OREGON

Milwaukie

Chas H Day Co, Inc.
11405 SE 37th Ave.
97222
503-232-1659

PENNSYLVANIA

Christiana

Beiler's Pneumatics
718 Vintage Rd.
17509
610-593-7064

Jessup

Fastenal
1225 Mid Valley Dr.
18434
570-307-0992

Myerstown

Keystone Air Power
60 Elco Dr.
17067
717-866-9224

Robesonia

Rowe Sales & Services, Inc.
381 West Penn Ave.
19551
610-693-4031

TENNESSEE

Jackson

Compressors & Tools Inc.
109 Anglin Lane
38301
731-421-8068

Johnson City

Summers Hardware & Supply Co.
400 Buffalo St.
37604
423-461-4700

Memphis

DBH Distributors, Inc.
3325 Millbranch Rd.
38116
901-348-1155

Memphis

Pro Power, Inc.
7531 Bartlett Corp Cove E,
Suite 101
38133
901-383-7888

TEXAS

Denton

Fastenal
3833 Airport Rd.
76207
940-483-8667

Grand Prairie

CRC Inc. of Texas
1209 W. Carrier Pkwy. Ste. 300
75050
972-647-0161

Longview

Texas Air Hydraulic Service & Sup
251 S Eastman Rd.
75602
903-757-8211

Nederland

ATSCO (Associated Tool
Specialties Company)
3711 North Twin City Hwy.
77627
409-727-2166

VIRGINIA

Portsmouth

Hydraulic Service Co.
3215 Victory Blvd.
23702
757-487-2513

Richmond

Kaman Industrial
10402 Lakeridge Pkwy #100
Ashland
23005
804 355 8041

Roanoke

Cardinal Tools, Sales & Service, Inc
1546 Brownlee Ave SE
24014
540-981-9359
800-542-5747

Salem

C & C Assembly
2636 West Main St.
24153
540-904-6416

WASHINGTON

Seattle

Universal Repair Shop, Inc.
1611 Boylston Ave.
98122
206-322-2726

WEST VIRGINIA

Bluefield

Larry's Pneumatic Service, LLC
100 Princeton Ave.
24701
304-325-9262

WISCONSIN

Green Bay

Power Tool Service Co.
1180 Ashwaubenon St.
54304
920-437-2594

Menomonee Falls

Engman-Taylor Co Inc.
W142 N9351 Fountain Blvd.
53051
800-236-1975

Canadian Independent Service Centers

ALBERTA

Edmonton
Quality Tool Repair
11420-156 St.
T5M 3N2
780-702-1686

Spruce Grove
Axis Torque Ltd
302 Commerce Rd. N.
T7X 3A5
780-962-4499

MANITOBA

Winnipeg
Accutool Service Center
532 Berry St.
R3H 0R9
204-772-6523

NEWFOUNDLAND

St. John's
Rideout Tool & Machine Inc
222 Kenmount Rd.
A1B 3R2
709-754-2240

NOVA SCOTIA
Dartmouth
Rideout Tool & Machine Inc
170 Akerley Blvd.
B3B 1Z5
902-468-2060

ONTARIO

Brampton
Grip Clinch Canada
73 Ward Rd.
M9W 6P3
416-742-9161

Brampton

HT Pneumatic
22 Goodmark Pl
M9W 6R2
416-407-5739

Etobicoke

H.T Pneumatic Rebuilders
22 Goodmark Pl
M9W 6R2
416-407-5739

London

Pryde Industrial Inc
187 Exeter Rd.
N6L 1A4
519-690-1111

QUEBEC

Laval
FGL Tools Service
949 Rue Michelin
H7L 5B6
450-972-7979

St. Laurent

Phoenix Inc.
5600 Vanden Abeels
H4S 1P9
514-334-5152

Trois Rivieres

Outil Mag
2415 Rue De La Sidbec Sud.
G8Z 4M6
819-370-4848

SASKATCHEWAN

Regina
All Tool Repairs
3100 - 12th Ave.
S4T 1J7
306-352-1756

Latin America Independent Service Centers

ARGENTINA

Assembly S.R.L.
Brazin 1313 P.B. 4
Capital Federal 1154
Buenos Aires, Argentina
Phone: (54-1) 304-7390

BOLIVIA

Herracruz Importaciones
Av. Roca Y Coronado # 295
Santa Cruz de La Sierra
Sebra, Bolivia
Phone: (591) 335-41073

BRAZIL

Sebra
Snap-on-Latin
American/Caribbean Division
Rua Juscelino Kubitscheck de
Oliveira 470
Distrito Industrial II
Santa Barbara D' Oeste
CEP 13456-401 SP
Brazil
Phone: (55-19) 2108-1000

CHILE

Perfect Technology Chile S.A.
Av. Americo Vespucio
Norte 2880, Of 505
El Cortijo, Conchali
Santiago, Chile
Phone: (56-2) 362-1153

COLUMBIA

Servitools LTDA
Carrera 58 Mp 14 - 14,
Zona Industrial Puente
Bogota, Colombia
Phone: (57-1) 420-3599

ECUADOR

Najomez
Mosquera Narvaez 746 y
Carvajal
Quito, Ecuador
Phone: (562) 2359845

HONDURAS

Herramientas la Atlantica
2da. Calle, 17 Ave. N.E.
Col. Universal
Carretera Vieja a La Lima
San Pedro Sula
Honduras
Phone: (504) 557-6314

MEXICO

Herramientas Holman S.A. DE C.V.
Dr. Atl 1302
Col. Roble San Nicolas
San Nicolas De Los Garza, N.I.
C.P. 66414
Phone: (81) 8353 4183

Lider Power Tools S.A. DE C.V.
Gregorio Zambrano 500
Residencial El Roble
San Nicolas De Los Garza, N.I.
C.p. 66414
Phone: (81) 8350 8517

Puebla
Puebla, Puebla, México
Tel. 222 940 0313
Whatsapp 222 531 2925

RC Maquinarias S.A. DE CV
Calzada Ignacio Zaragoza
N° 377
Col. San Pedro
Puebla, Pue
Mexico
Phone: (52-222) 222-2587

RC Maquinarias S.A. de CV
Subsidiary
Calle Diego Rivera N° 39
Privada Diego Rivera
Col. Los Alcanfores C.P. 76150
Queretaro
Que, Mexico
Phone: (52-442) 217-7435

Romihn Aguascalientes
Aguascalientes, Aguascalientes,
México
Tel. 449 555 0276
Whatsapp 449 205 4364

Romihn Cdmx (Mexico City)
Tlalnepantla, Edo. de México,
México
Tel. 55 5039 1478
Whatsapp 553 408 1489

Romihn Puebla
Calle Adolfo López Mateos No.
90-B
Col. San Pedro CP 72210
Puebla, Puebla, México
Tel. 222 940 0313
Whatsapp 222 531 2925

Romihn Queretaro
Corregidora, Querétaro, México
Tel. 442 384 0144
Whatsapp 442 595 3617

Romihn Queretaro Industrial Park
Querétaro, Querétaro, México
Tel. 442 628 2176
Whatsapp 442 668 1414

Snap-on S un De Mexico,
S.A. de C.V.
Av Gustavo Baz, No. 166B
Colonia La Escuela
Tlalnepantla, Edo de Mixico
Mexico 54090
Phone: (52-55) 5010-3000
www.snapon.com.mx

Snap-on Sun De Mexico,
S.A. de C.V.
Gustavo Baz No 180-F
Tlalnepantla, Edo. de Mex.
CP 54090
Phone: (55) 5010 3060
contactanos@snapon.com

NICARAGUA

Sistemas de
Seguridad Buhler S.A.
Contiguo donde fue
Cine Dorado
Bolonía, Managua
Nicaragua
Phone: (505) 2222-6833

PARAGUAY

H Petersen
Av. Artigas 1552
Asuncion, Paraguay
Phone: (595-21) 202-615

PERU

Energotec S.A.
Calle Los Plasticos 204
Ate- Lima 3
Peru
Phone : (51-1) 348-7570
Igardí Herramientas S.A.
Av. Javier Prado (FSTE) #1131
Lima, Peru
Phone : (30-5) 887-3533

VENEZUELA

Refiteca
Calle E. Boleita Norte
Edificio Alexandro
Local A. Semisotano
Caracas, Venezuela
Phone: (58-212) 235-8042

Hermaco
Av. Intercomunal N° 428
Ciudad Ojeda
Estado Zulia, Venezuela
Phone : (58-65) 260-994

UK and Europe Independent Service Centers

UK

Snap-on Tools LTD Repair Centre
Telford Way Industrial Estate
Kettering, Northants
NN168 PU, Great Britain
Phone: 011-44-1536-413903

POLAND

Tri Color Industrial
Orcowska 110
Cracow 31-344
Phone: (48) 12-642-27-23

THE NETHERLANDS

JCO Tools en Services
Berkblad 19
3233 SR Oostvoorne
(Zuid-Holland)
Phone: (31) (0) 657829507

SIOUX TOOLS INDUSTRIAL CATALOG | CONVERSION CHART

INCH	DECIMAL	MILLIMETER	MILLIMETERS	INCHES	MILLIMETERS	INCHES	FOOT POUNDS	NEWTON METERS	FOOT POUNDS	NEWTON METERS
1/64	.0156	0.397	26	1.0236	94	3.7008				
1/32	.0312	0.794	27	1.0630	95	3.7402	18	24.4	85	115.2
	.0394	1.000	28	1.1024	96	3.7795	19	25.8	86	116.6
3/64	.0469	1.191	29	1.1417	97	3.8189	20	27.1	87	117.9
1/16	.0625	1.587	30	1.1811	98	3.8583	21	28.4	88	119.3
5/64	.0781	1.984	31	1.2205	99	3.8976	22	29.8	89	120.7
	.0787	2.000	32	1.2598	100	3.9370	23	31.2	90	122.0
3/32	.0937	2.381	33	1.2992	110	4.3307	24	32.5	91	123.4
7/64	.1094	2.778	34	1.3386	120	4.7244	25	33.9	92	124.7
	.1181	3.000	35	1.3780	130	5.1181	26	35.3	93	126.0
1/8	.1250	3.175	36	1.4173	140	5.5118	27	36.6	94	127.4
9/64	.1406	3.572	37	1.4567	150	5.9055	28	38.0	95	128.8
5/32	.1562	3.969	38	1.4961	160	6.2992	29	39.3	96	130.2
	.1575	4.000	39	1.5354	200	7.8740	30	40.7	97	131.5
11/64	.1719	4.366	40	1.5748	300	11.8110	31	42.0	98	132.9
3/16	.1875	4.762	41	1.6142	400	15.7480	32	43.4	99	134.2
	.1968	5.000	42	1.6535	500	19.6850	33	44.7	100	135.6
13/64	.2031	5.159	43	1.6929	600	23.6220	34	46.1	110	149.0
7/32	.2187	5.556	44	1.7323	700	27.5591	35	47.5	115	156.0
15/64	.2344	5.953	45	1.7717	800	31.4961	36	48.8	120	163.0
	.2362	6.000	46	1.8110	900	35.4331	37	50.2	125	170.0
1/4	.2500	6.350	47	1.8504	1000	39.3701	38	51.5	130	176.0
17/64	.2656	6.747	48	1.8898			39	52.9	135	183.0
	.2756	7.000	49	1.9291	INCH POUNDS	NEWTON METERS	40	54.2	140	190.0
9/32	.2812	7.144	50	1.9685	5	0.565	41	55.6	145	197.0
19/64	.2969	7.541	51	2.0079	10	1.13	42	56.9	150	203.0
5/16	.3125	7.937	52	2.0472	15	1.70	43	58.3	155	210.0
	.3150	8.000	53	2.0866	20	2.26	44	59.7	160	217.0
21/64	.3281	8.334	54	2.1260	25	2.83	45	61.0	165	224.0
11/32	.3437	8.731	55	2.1654	30	3.39	46	62.4	170	231.0
	.3543	9.000	56	2.2047	35	3.96	47	63.7	175	237.0
23/64	.3594	9.128	57	2.2441	40	4.52	48	65.0	180	244.0
3/8	.3750	9.525	58	2.2835	45	5.09	49	66.4	185	251.0
25/64	.3906	9.922	59	2.3228	50	5.65	50	67.8	190	258.0
	.3937	10.000	60	2.3622	60	6.78	51	69.1	195	264.0
13/32	.4062	10.319	61	2.4016	70	7.91	52	70.5	200	271.0
27/64	.4219	10.716	62	2.4409	80	9.04	53	71.9	225	305.0
	.4331	11.000	63	2.4803	90	10.17	54	73.2	250	339.0
7/16	.4375	11.112	64	2.5197	100	11.3	55	74.6	275	373.0
29/64	.4531	11.509	65	2.5591	110	12.4	56	75.9	300	407.0
15/32	.4687	11.906	66	2.5984	120	13.6	57	77.3	350	474.0
	.4724	12.000	67	2.6378	130	14.7	58	78.6	400	542.0
31/64	.4844	12.303	68	2.6772	140	15.8	59	80.0		
1/2	.5000	12.700	69	2.7165	150	17.0	60	81.3		
	.5118	13.000	70	2.7559	160	18.1	61	82.7		
33/64	.5156	13.097	71	2.7953	170	19.2	62	84.0		
17/32	.5312	13.494	72	2.8346	180	20.3	63	85.4		
35/64	.5469	13.891	73	2.8740	190	21.5	64	86.8		
	.5512	14.000	74	2.9134	200	22.6	65	88.1		
9/16	.5625	14.287	75	2.9528			66	89.5		
37/64	.5781	14.684	76	2.9921	FOOT POUNDS	NEWTON METERS	67	90.8		
	.5906	15.000	77	3.0315	1	1.356	68	92.2		
19/32	.5937	15.081	78	3.0709	2	2.7	69	93.5		
39/64	.6094	15.478	79	3.1102	3	4.0	70	94.9		
5/8	.6250	15.875	80	3.1496	4	5.4	71	96.3		
	.6299	16.000	81	3.1890	5	6.8	72	97.6		
41/64	.6406	16.272	82	3.2283	6	8.1	73	99.0		
21/32	.6562	16.669	83	3.2677	7	9.5	74	100.3		
	.6693	17.000	84	3.3071	8	10.8	75	101.7		
43/64	.6719	17.066	85	3.3465	9	12.2	76	103.0		
11/16	.6875	17.462	86	3.3858	10	13.5	77	104.4		
45/64	.7031	17.859	87	3.4252	11	14.9	78	105.8		
	.7087	18.000	88	3.4646	12	16.3	79	107.1		
23/32	.7187	18.256	89	3.5039	13	17.6	80	108.5		
47/64	.7344	18.653	90	3.5433	14	18.9	81	109.8		
	.7480	19.000	91	3.5827	15	20.3	82	111.2		
3/4	.7500	19.050	92	3.6220	16	21.7	83	112.5		
49/64	.7656	19.447	93	3.6614	17	23.0	84	113.9		
25/32	.7812	19.844								
	.7874	20.000								
51/64	.7969	20.241								
13/16	.8125	20.637								
	.8268	21.000								
53/64	.8281	21.034								
27/32	.8437	21.431								
55/64	.8594	21.828								
	.8661	22.000								
7/8	.8750	22.225								
57/64	.8906	22.622								
	.9055	23.000								
29/32	.9062	23.019								
59/64	.9219	23.416								
15/16	.9375	23.812								
	.9449	24.000								
61/64	.9531	24.209								
31/32	.9687	24.606								
	.9843	25.000								
63/64	.9844	25.003								
	1.0000	25.400								

HEX SOCKET CONVERSIONS
 10mm=0.394"
 11mm=0.433"
 12mm=0.472"
 13mm=0.512"
 14mm=0.551"
 15mm=0.591"
 16mm=0.630"
 17mm=0.669"
 18mm=0.704"
 19mm=0.748"
 20mm=0.787"
 21mm=0.827"

Inch Lbs. x 0.113=Nm; Nm x 8.849=Inch Lbs.; Ft. Lbs x 1.356=Nm; Nm x 0.737=Ft. Lbs.

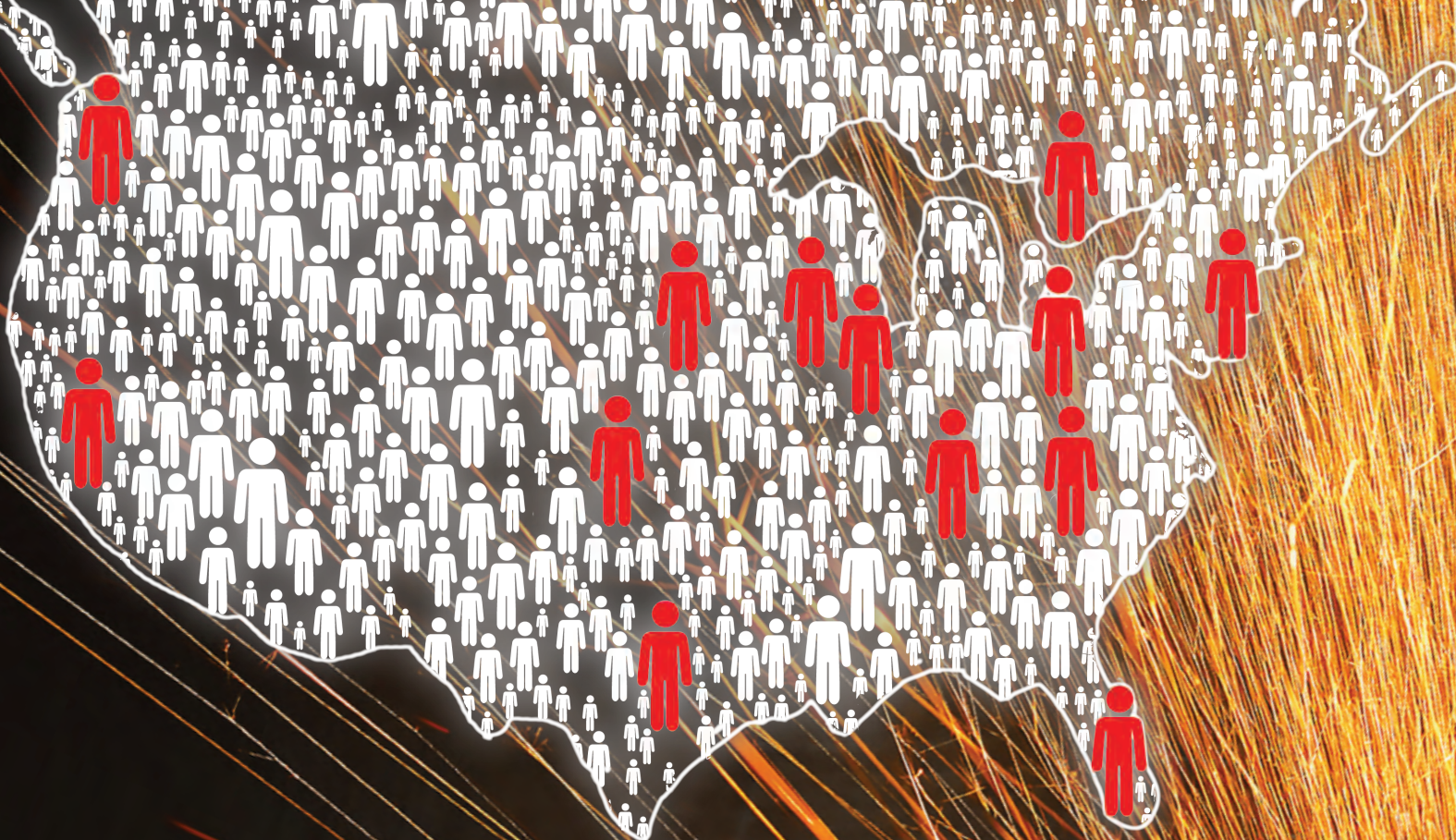

FIELD EXPERTS MATTER



A major advantage for Sioux customers is our North American -Factory Trained Technical Sales Force. These professionals are dedicated to inform, educate and solve problems so you can work more efficiently and increase productivity.

250 Snap-on Drive
P.O. Box 1596
Murphy, North Carolina USA 28906
PH: 828.835.9765
FAX: 828.835.9685
TOLL FREE: 866.259.7291
TOLL FREE FAX: 800.722.7236

Belgium
Tel.: 32 (0)14 23 19 67
Fax: 32 (0)14 23 26 27
e-mail: Industrial.be@snapon.com

Netherlands
Tel.: 31 (0)88 0104000
Fax: 31 (0)88 0104010
e-mail: Industrial.nl@snapon.com

Latin America
Tel.: 786-254-7765
Fax: 786-534-9350
e-mail: latinamerica.caribbean@snapon.com

Germany
Tel.: 49 2104 9509-0
Fax: 49 2104 9509-99
e-mail: indus.germany@snapon.com

Italy
Tel.: 00 39 02 66 04 53 70
Fax: 00 39 02 61 29 78 15
e-mail: indus.italia@snapon.com

United Kingdom
Tel.: 44 (0) 1536-413904
Fax: 44 (0) 1536-413874
e-mail: industrialuk@snapon.com

Asia
Tel.: 65-6451-5570
Fax: 65-6451-5574
email: esales.sg@snapon.com

Australia
Tel.: 61 2 9837 9100
Fax: 61 2 9624 2578
e-mail: SOTA.customerservice@snapon.com



FORM# ZML0014
PRINTED IN USA
5/21 7500

www.siouxtools.com