



ABRASIVES CATALOG

DYNABRADE ABRASIVE SOLUTIONS

DYNABRADE ABRASIVE SOLUTIONS

DYNABRADE ABRASIVES CATALOG



WE LISTEN. WE OBSERVE. WE OPTIMIZE.



ABOUT US

Mission Statement

The Dynabrade Difference! Designing high-quality tools and innovative solutions, creating superior finishes, being friendly and easy to do business with, and making our customers and employees enjoy their experience with Dynabrade!

Vision Statement

The first choice for abrasive power tools and finishing solutions, today and tomorrow!

Who We Are

Founded in 1969, Dynabrade has earned a reputation for excellence and a position of leadership in the innovative design and manufacturing of unique portable abrasive power tools and related accessories. With over 800 high-quality tools in our product line, we are able to meet the specific needs of industrial and automotive markets. Our products and accessories are used in grinding, deburring, filing, sanding and polishing applications on materials such as metal, wood, plastic, glass, rubber, stone and composites. We supply these products to customers through a worldwide network of professional distributors/jobbers.

Customer Service

Dynabrade's Customer Service staff has just one important job – to make sure that you are completely satisfied with your order and service. Our Customer Service Department is staffed with highly trained people, ready to serve you in any way they can, from ordertaking to technical service to rush shipments! In short, our commitment to customer service is to satisfy our customers by serving them well. If we can help or improve in any way, we'd like to hear from you.

Free Demonstration Policy

We can arrange a no-obligation demonstration in your facility on most of our products. It is a sure way to see that the product is best suited to your application and to see the time, labor and cost-saving advantages of Dynabrade products. Contact your local Dynabrade distributor to arrange an in-plant demonstration.



DYNACUT™ COATED ABRASIVES

Belts	5-20
- Narrow Belts	6-20
- Expanding	19-20
Discs	21-52
- Film & Paper Discs	21-37
- Quick Change Discs	38-42
- Flap Discs	43-48
- Fiber Discs	49-52
Sheets	53-65
- Film Paper & Detail Sheets	53-65
Specialties	66-84
- Sanding Stars	68-70
- Cross Pads	71-72
- Square Pads	73
- Overlap Slotted Discs	74
- Cartridge Rolls	75-79
- Spiral Bands	80-81
- Flap Wheels & Brushes	82-84
Flap Brushes	85-91
Rolls	92-94
- Lapping & Microfinishing	92-94

DYNABRITE™ ABRASIVES

Belts	95-101
Discs	102-109
- Locking Discs	105
- Center Hole Discs	106
- Unitized Discs	107
- Hook & Loop Discs	108
- High Strength Arbor Hole Discs	108
- Dynastrip™ Discs	109
Convolute Wheels	110
- Film Paper & Detail Sheets	110
Non-Woven Specialties	111-113
- Eyelet Stars	111
- Spiral Bands	112
- Flap Wheels	113
- Hand Pads	113

POWER BRUSHES

Power Brushes	114-122
- Wire Wheels	117
- Cup Brushes	118
- End Brushes	119-120
- Wheel Brushes	121-122

CARBIDE BURRS

Carbide Burrs	123-126
- Dynaburr Kits	126

BONDED ABRASIVES

Bonded Abrasives	127-131
- Mounted Points	129-130
- Cut-Off Wheels	131
- Depressed Center Wheels	131
- Snagging Wheels	131

POLISHING

Polishing	132-133
- Synthetic White	132
- Buffing Compounds	132
- Locking-Type Discs	132
- Hook-Face Buffing Pads	133

MISCELLANEOUS

Miscellaneous	134-135
- Saw Blades	134
- Double Cut Swiss Pattern	134
- Diamond Wheels	135
- Dynascaler Flaps & Hub	135
- Scribe Points & Chisels	135

COATED ABRASIVE BASICS

Coated Abrasive Basics	136-138
------------------------------	---------

TESTING ABRASIVES

Testing Abrasives	139-140
- Cost Savings.....	140

GRIT GRADING SYSTEMS

Grit Grading Systems	141
----------------------------	-----

GLOSSARY

Common Terms & Definitions	142-143
----------------------------------	---------

PAGE SETUP & CATALOG NAVIGATION

1 COATED ABRASIVE BELTS

2 NARROW BELTS 24" COATED ABRASIVES CONTINUED

3 PERFORMANCE TIERS

4 ABRASIVE VISUAL REFERENCE

5 TOOLS USED

6 COMPATIBLE ACCESSORIES

ABRASIVE GRAINS

- Ceramic Alumina (PCER)
- Ceramic Alumina (CER)
- Zirconia Alumina (ZIA)
- Aluminum Oxide (AO)

DYNAPREP™ P/EER **1** **2** **3** **4** **DYNACUT™** **DYNACUT™ Z/A** **DYNACUT™ AO**

Length	Width	Grit	Item #	Item #	Item #	Item #	Qty
1" (25 mm)	24" (610 mm)	40	79150	79064	91153	-	50
		60	79151	79065	-	50	
		80	79152	79066	-	50	
		120	79194	79067	-	50	
		180	-	-	90486	50	
1-1/2" (38 mm)	24" (610 mm)	60	-	-	91432	10	
		80	-	-	91433	10	
		120	-	-	91434	10	
		180	-	-	91435	10	
		220	-	-	91428	10	
3" (76 mm)	24" (610 mm)	36	-	79043	-	10	
		40	-	79050	-	10	
		60	-	79051	-	10	
		80	-	79052	-	10	
		120	-	79053	-	10	

• Call for availability and pricing.

TOOL POST GRINDER

TAKE-ABOUT SANDER ABRASIVE BELT TOOL

PAGE GUIDE

- 1 PRODUCT CATEGORY** - Easily find the major section of the catalog.
 → LOCATION - Top right tab.
- 2 PRODUCT TYPE** - Describes abrasive type & size.
 → LOCATION - Top left heading.
- 3 PERFORMANCE TIERS** - Depicts mineral & available tiers.
 → LOCATION - Pinwheel at center of page.
- 4 ABRASIVE VISUAL REFERENCE** - Provides an example of top performing tier.
 → LOCATION - Left margin.
- 5 TOOLS USED** - Visual reference of which tools the abrasive can be used on.
 → LOCATION - Right margin.
- 6 COMPATIBLE ACCESSORIES** - Lists relevant accessories for use with tools & abrasives found on the page.
 → LOCATION - Bottom of page.

CONTACT ARM PLATEN PADS BELT SUPPORT FOR ABRASIVE BELT TOOLS

Softer, wider platen pads allow belts to conform to a work surface; hard, thin platens provide greater unit pressure for consistent mineral breakdown in aggressive applications.

6

FOR WORK ON CONTOURED PIECES

FOR HEAVY DEBURRING & POLISHING

FOR USE WITH CONTACT ARMS WITH SMALL DIAMETER CONTACT WHEELS

Material	Width	Length	Thickness	Item #	Qty
Soft	1/4"	7"	1/8"	11032	5
	1/2"	7"		11025	5
	3/4"	7"		11119	5
	1"	2"		15223	5
Hard	1/4"	7"	1/8"	11033	5
	1/2"	7"		11026	5
	3/4"	7"		11109	5
	1"	2"		15224	5
Thin	1/4"	7"	1/32"	11034	5
	1/2"	7"		11027	5
	3/4"	7"		11129	5

- 7 PRODUCT GROUP INTRO** - Describes major characteristics of the product.
 → LOCATION - Top of page.
- 8 APPLICATION GUIDE** - Provides general guidelines of where each tier of abrasive performs best.
 → LOCATION - Top quarter of page.
- 9 TIER DESCRIPTION** - Detailed description of the features and benefits unique to each product tier.
 → LOCATION - Beginning intro of each section.
- 10 PRODUCT PHOTO** - Provides visual reference of specific products.
 → LOCATION - Found on either left or right margin.

DYNAPREP™ NON-WOVEN ABRASIVE BELTS

Surface conditioning belts are a combination of a strong, low-stretch, synthetic mesh or woven cloth backing and quality abrasives bonded together by flexible yet tough adhesives. The open construction of the non-woven surface generates an aggressive cutting action, provides non-loading performance and generates improved surface finishes. Belts are coated with aluminum oxide in coarse, medium, very fine, and silicon carbide in superfine.

7

APPLICATION GUIDE

	EXTRA COARSE	COARSE	MEDIUM	FINE	VERY FINE	SUPER FINE
Scale Removal	█					
Stock Removal	█	█				
Heavy Deburring	█	█				
Light Deburring		█	█			
Light Finishing			█	█		
Blending				█	█	
Finishing					█	█

8

ABRASIVE GRIT KEY

- Extra Coarse
- Coarse
- Medium
- Fine
- Very Fine
- Super Fine

DYNAPREP™ PREMIUM PLUS

The BEST choice for all finishing and blending applications. Provides the lowest total cost of consumable tooling.

9

FEATURES

- This premium surface conditioning material utilizes sharp heat treated aluminum oxide abrasive
- Proprietary resin technology
- Most consistent cutting and finishing surface conditioning material available
- More resistant to edge wear
- Thicker layer of grain is evenly dispersed throughout the product surface, not just coated on top

BENEFITS

- Maintains RA specifications throughout product life, reducing scrap and rework. "Smear free" even on high nickel content alloys.
- Resists loading on aluminum or other soft materials.
- Can provide up to 2 times the life of competitive products.
- Can reduce processing time by 50% or greater.

1

DYNAPREP™ PREMIUM

The BETTER choice for finishing and blending applications that demand a higher performance product.

2

FEATURES

- High-performance aluminum oxide, smear resistant resin and durable cloth mesh backing

BENEFITS

- Provides an aggressive cutting action that reduces cycle times.

10

DYNAPREP™

The GOOD choice for all finishing and blending applications on a variety of materials.

3

FEATURES

- 2-Dimensional, open structure, non-woven surface conditioning material coated throughout with Aluminum Oxide abrasive in the coarse, medium and very fine grades
- Coated with silicon carbide abrasive in the superfine grade

BENEFITS

- For a long life and consistent finishes on ferrous and nonferrous metals.
- For generating bright final finishes on ferrous and nonferrous metals.

NARROW BELTS COATED ABRASIVES



DYNACUT™ COATED ABRASIVES

Dynabrade is the company that created the first portable power tool solution for automating the finishing of difficult to reach areas, the Dynaflex®. Dynabrade's Dynacut™ Coated Abrasive belt offering covers the full range of innovative, problem solving Dynabrade belt tools with a multi tiered line engineered to deliver maximum benefit on virtually any material or application.

BELTS	5-20
↳ Narrow Belts	5-20
↳ Expanding Drum/Wheel Belts	19-20

NARROW BELTS COATED ABRASIVES

Today's narrow belt sanders have been able to replace many of the sanding and filing applications previously done by hand. Our wide range of Dynafire®, Dynabelter, Bench and Versatility grinders enable the end user to accomplish a broad number of applications on a wide variety of materials.

APPLICATIONS: light to medium weld removal, shaping, blending and contouring, surface preparation prior to coating or plating and general surface improvement and finishing.

Size Range: 1/8" - 3" wide and 11" - 72" long

Grit range: 36 to 320 grit

1 DYNAFIRE™ PCER PREMIUM CERAMIC

The PREFERRED choice for mild and carbon steel, stainless steel, cobalt, chrome, Inconel and titanium.

FEATURES

- 1 Next generation ceramic alumina grain →
- 2 Heavy duty Y-wt. polyester cloth backing →

BENEFITS

- Cuts up to 20% faster and lasts 50% to 200% longer than aluminum oxide abrasives.*
- Provides excellent edge fray resistance and body retention during use for more consistent grinding throughout belt life resulting in greater productivity and the lowest total grinding costs.*



2 DYNACUT™ CER CERAMIC

The BEST choice for mild and carbon steel, stainless steel, cobalt, chrome, Inconel and titanium.

FEATURES

- 1 High performance ceramic abrasive →
- 2 A sturdy Y-wt. cloth backing →

BENEFITS

- Has improved self-sharpening characteristics providing high stock removal and longer life.*
- Offers reliable performance with advanced cutting resin technology which reduces heat. Suitable for high pressure grinding applications.*



3 DYNACUT™ Z/A ZIRCONIA

The BETTER choice for metalworking and finishing on stainless steel, nickel alloy, forged steel, and aluminum.

FEATURES

- 1 Premium self-sharpening zirconia alumina abrasive →
- 2 Y-wt. polyester backing →

BENEFITS

- Generates an aggressive and rapid cut rate.*
- Provides for excellent grain adhesion, edge fray resistance and better body retention resulting in long-life and product consistency.*



NARROW BELTS COATED ABRASIVES

4

DYNACUT™ A/O ALUMINUM OXIDE

A GOOD choice for general purpose applications. Primarily used on softer metals for light to heavier grinding and blending on aluminum, carbon steel, brass, and bronze.

FEATURES

- 1 High performance aluminum oxide abrasive →
- 2 A sturdy X-wt. cloth backing →

BENEFITS

Has improved self-sharpening characteristics providing high stock removal and longer life.

Offers reliable performance.



5

DYNACUT™ S/C SILICON CARBIDE

The IDEAL choice for none ferrous metals, glass, plastic and composites.

FEATURES

- 1 Silicon carbide is the hardest and sharpest of the synthetic abrasives. →

BENEFITS

Breaks down freely under lighter pressures for intermediate and final sanding and polishing applications.



DYNACUT™ S/C 18" COATED ABRASIVES

Length	Width	Grit	Item #	Std. Pkg.
18" (457 MM)	1" (25 mm)	80	78186	10
		100	78187	10
		240	78188	10
		400	78189	10

TOOLS USED →

DYNAFILE® III



REFER TO EACH LIT PIECE FOR BELT TOOLS

SEE THE COMPLETE LINE AT DYNABRADE.COM

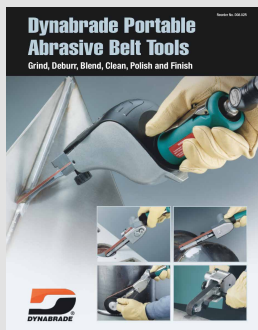

D08.02R

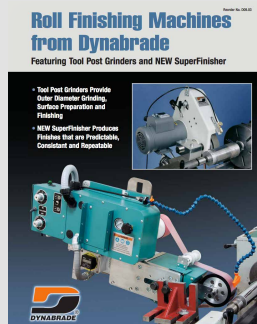

D09.03

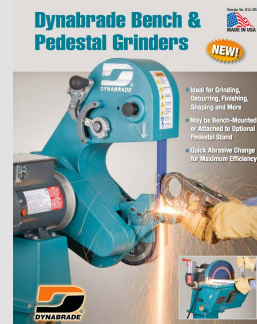

D12.13

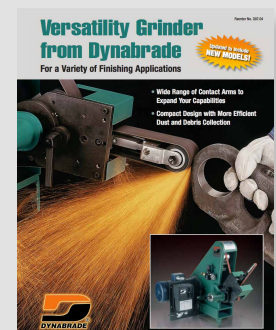

D07.04

NARROW BELTS 12" – 13" COATED ABRASIVES

PERFORMANCE TIERS



ABRASIVE GRAINS

- Ceramic Alumina (PCER)
- Ceramic Alumina (CER)
- Zirconia Alumina (Z/A)
- Aluminum Oxide (A/O)

TOOLS USED



12" (305 MM)



13" (330 MM)

Length	Width	Grit	Item #	Item #	Item #	Item #	Qty	
12" (305 MM)	1/8" (3 mm)	80	79103	•	79004	92206	50	
		120	79183	•	79005	92207	50	
		180				92208	50	
		220				92209	50	
		320				92210	50	
	1/4" (6 mm)	40	79104	82521	79006	•	50	
		60	79105	82522	79007	91425	50	
		80	79106	82523	79008	91426	50	
		120	79184	•	79009	91427	50	
		180				92118	50	
		220				92119	50	
	1/2" (13 mm)	36	•	82525	•	•	50	
		40	79107	82526	79010	•	50	
		60	79108	82527	79011	91428	50	
		80	79109	82528	79012	91429	50	
		120	79185	82529	79013	91430	50	
		180				92114	50	
		220				92115	50	
		320				92116	50	
	Assorted				79202	50		
	13" (330 MM)	3/8" (10 mm)	60			79074	91162	50
			80			79075	91163	50
			120			79076	91164	50
		1/2" (13 mm)	60			79077	91165	50
80					79078	91166	50	
120					79079	91167	50	

• Call for availability and pricing.



15003



15013

NARROW BELTS 18" COATED ABRASIVES

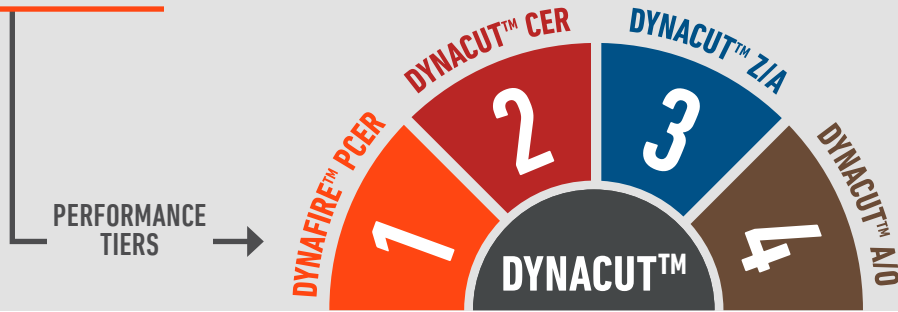

ABRASIVE GRAINS

- Ceramic Alumina (PCER)
- Ceramic Alumina (CER)
- Zirconia Alumina (Z/A)
- Aluminum Oxide (A/O)

Length	Width	Grit	Item #			Qty	
			Item #	Item #	Item #		
1/8" (3 mm)	1/8" (3 mm)	60	•	•	•	90211	50
		80	79118	82558	79024	92228	50
		120	79186	82563	79025	92229	50
		180				92232	50
		220				92233	50
		320				92234	50
1/4" (6 mm)	1/4" (6 mm)	36	•	82545	79070	•	50
		40	79119	82549	79026	91142	50
		60	79120	82554	79027	91114	50
		80	79121	82559	79028	91115	50
		120	79187	82564	79029	91116	50
		180				90224	50
1/2" (13 mm)	1/2" (13 mm)	220				90225	50
		320				90226	50
		36	•	82546	79015	•	50
		40	79122	82550	79030	91143	50
		60	79123	82555	79031	91117	50
		80	79124	82560	79032	91118	50
		120	79188	82565	79033	91119	50
		180				90244	50
		220				90245	50
		320				90246	50
Assorted					79201	50	



• Call for availability and pricing.

DYNAFILE® III
SLACK POLISHING APPLICATION

15300 Dynafile® III
Utilizing 1" wide abrasive belts and the slack portion of the contact arm. The Dynafile® III easily blends and polishes bends in pipes while maintaining original dimensions. The added horsepower provided by the .7 hp motor in the Dynafile® III efficiently powers 1" wide belts in both grinding and polishing applications.



NARROW BELTS 18" COATED ABRASIVES CONTINUED

ABRASIVE GRAINS

	Ceramic Alumina (PCER)
	Ceramic Alumina (CER)
	Zirconia Alumina (Z/A)
	Aluminum Oxide (A/O)

PERFORMANCE TIERS →

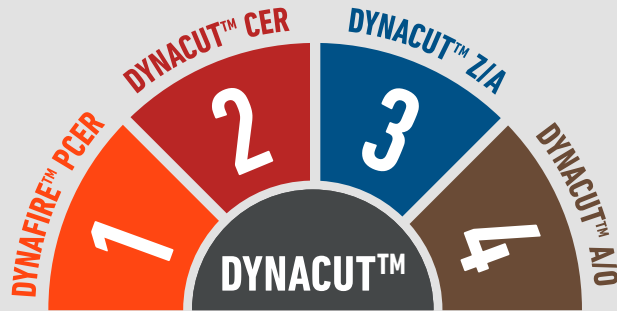

TOOLS USED →



Length	Width	Grit	Item #	Item #	Item #	Item #	Qty
18" (457 MM)	3/4" (19 mm)	36	•	82547	79017	•	50
		40	79125	82551	79034	91144	50
		60	79126	82561	79035	91123	50
		80	•	•	79036	•	50
		120	79127	82566	79037	91125	50
		180	•	90254	•	•	50
		220	•	90255	•	•	50
		320	•	90256	•	•	50
	1" (25 mm)	36	79114	82548	79019	•	50
		40	79128	82552	79038	91150	50
		60	79129	82557	79039	91126	50
		80	79175	82562	79040	91157	50
		120	79190	82567	79041	91128	50
		180	•	90288	•	•	50
		220	•	90286	•	•	50
		320	•	90290	•	•	50



• Call for availability and pricing.

COMPETITOR CROSS REFERENCE GUIDE

	1	2	3	4
	DYNAFIRE™ PCER	DYNACUT™ CER	DYNACUT™ Z/A	DYNACUT™ A/O
NORTON	R980P	R983	R823	R283
3M	984, 947A, 777F	947A, 777F	577F	241E
HERMES	CR456	CR456	RB486, RB386	
SIA			933A, 936A	2905X, 2920X
VSM	SK855, SK840X, SK750X	SK855, SK840X, SK750X	KK715X	KK711T, KK511J

NARROW BELTS 19-1/4" & 20-1/2" COATED ABRASIVES

PERFORMANCE TIERS



ABRASIVE GRAINS

- Ceramic Alumina (PCER)
- Ceramic Alumina (CER)
- Zirconia Alumina (Z/A)
- Aluminum Oxide (A/O)

TOOLS USED



Length	Width	Grit	Item #	Item #	Item #	Item #	Qty
19-1/4" (489 MM)	2" (51 mm)	60	•	•	92263	•	10
		80	•	•	92264	•	10
		120	•	•	92265	•	10
20-1/2" (521 MM)	3/4" (19 mm)	40	79133	•	90640	•	50
		60	79134	•	90641	•	50
		80	79135	•	90642	•	50
		120	•	•	90643	•	50
		180	•	•	•	90334	50
		220	•	•	•	90335	50
		320	•	•	•	90336	50
		Assorted	•	•	•	79203	50

• Call for availability and pricing.

MATERIAL TO DYNACUT™ RECOMMENDATION GUIDE

	HIGHEST PERFORMANCE LOWEST TOTAL COST		PERFORMANCE PRICE VALUE	GENERAL DUTY LOW PRICE
	1	2	3	4
	DYNAFILE™ PCER	DYNACUT™ CER	DYNACUT™ Z/A	DYNACUT™ A/O
CARBON STEEL	•	•	•	•
STAINLESS STEEL / ALLOYS	•	•	•	•
CAST IRON	•	•	•	•
DIE CASTINGS	•	•	•	•
GLASS / CERAMICS	•	•	•	•
ALUMINUM	•	•	•	•
BRASS / BRONZE	•	•	•	•
WOOD	•	•	•	•

NARROW BELTS 24" COATED ABRASIVES

ABRASIVE GRAINS

-  Ceramic Alumina (PCER)
-  Ceramic Alumina (CER)
-  Zirconia Alumina (Z/A)
-  Aluminum Oxide (A/O)

PERFORMANCE TIERS



TOOLS USED



Length	Width	Grit	Item #				Qty
			Item #	Item #	Item #	Item #	
24" (610 MM)	1/8" (3 mm)	50	•	82531	•	•	50
		60	79139	•	79049	90405	50
		80	79143	82575	79054	90407	50
		120	79191	82578	79055	90409	50
		180				90410	50
		220				90411	50
		320				90412	50
	1/4" (6 mm)	36	•	82568	79046	•	50
		40	79144	82570	79056	91151	50
		60	79145	82573	79057	91434	50
		80	79146	82576	79058	91435	50
		120	79192	82579	79059	91436	50
		180				90423	50
		220				90424	50
	1/2" (13 mm)	36	•	82569	79047	•	50
		40	79147	82571	79060	91152	50
		50	•	82533	•	•	50
		60	79148	82574	79061	91437	50
		80	79149	82577	79062	91438	50
		120	79193	82580	79063	91439	50
		180				90449	50
220				90451	50		
320				90453	50		

• Call for availability and pricing.

THE "ORIGINAL" DYNAFILE®

APPLICATION SOLUTIONS

World-famous 14000 Dynafiler® replaces tedious hand-sanding and filing in an endless array of applications. In this photo the Dynafiler® is powering an optional 11237 Contact Arm, ideal for working in areas as small as 3/8" (10mm). The arm is also utilized for turbine blade grinding, blending and polishing.

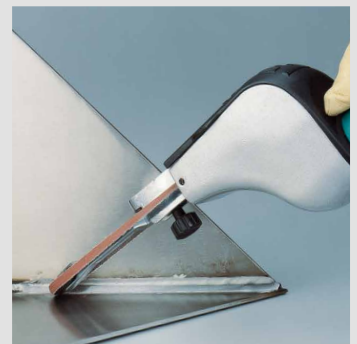

NARROW BELTS 24" COATED ABRASIVES CONTINUED

ABRASIVE GRAINS

- Ceramic Alumina (PCER)
- Ceramic Alumina (CER)
- Zirconia Alumina (Z/A)
- Aluminum Oxide (A/O)

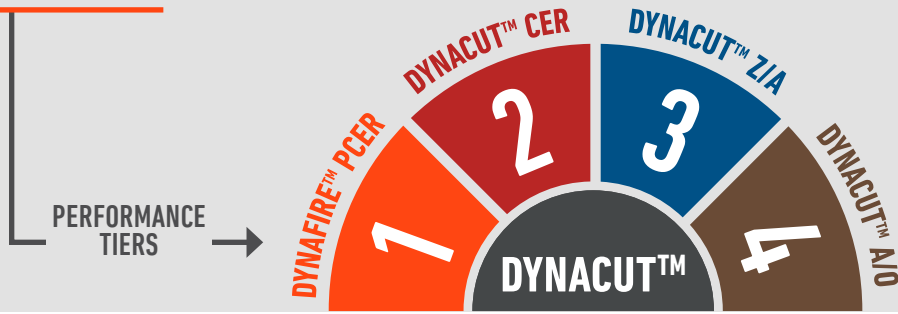

Length	Width	Grit	Item #	Item #	Item #	Item #	Qty
24" (610 MM)	1" (25 mm)	40	79150	•	79064	91153	50
		60	79151	•	79065	•	50
		80	79152	•	79066	•	50
		120	79194	•	79067	•	50
		180				90486	50
		220				90487	50
	1-1/2" (38 mm)	60	•	•	•	91632	10
		80	•	•	•	91633	10
		120	•	•	•	91634	10
		180				91635	10
		220				91628	10
		320				91629	10
	3" (76 mm)	36	•	•	79043	•	10
		40	•	•	79050	•	10
		60	•	•	79051	•	10
		80	•	•	79052	•	10
		120	•	•	79053	•	10

• Call for availability and pricing.

TOOL POST GRINDER



TAKE-ABOUT SANDER ABRASIVE BELT TOOL



CONTACT ARM PLATEN PADS BELT SUPPORT FOR ABRASIVE BELT TOOLS

FOR WORK ON CONTOURED PIECES



FOR HEAVY DEBURRING & POLISHING



FOR USE WITH CONTACT ARMS WITH SMALL DIAMETER CONTACT WHEELS



Material	Width	Length	Thickness	Item #	Qty
Soft	1/4"	7"	1/8"	11032	5
	1/2"	7"		11025	5
	3/4"	7"		11119	5
	1"	2"		15323	5
Hard	1/4"	7"	1/8"	11033	5
	1/2"	7"		11026	5
	3/4"	7"		11109	5
	1"	2"		15324	5
Thin	1/4"	7"	1/32"	11034	5
	1/2"	7"		11027	5
	3/4"	7"		11129	5

Softer, wider platen pads allow belts to conform to a work surface; hard, thin platens provide greater unit pressure for consistent mineral breakdown in aggressive applications.

11025 Platen Pad affixed to 11218 Dynafite® Contact Arm



NARROW BELTS 30" COATED ABRASIVES

ABRASIVE GRAINS

- Ceramic Alumina (PCER)
- Ceramic Alumina (CER)
- Zirconia Alumina (Z/A)
- Aluminum Oxide (A/O)

PERFORMANCE TIERS →



TOOLS USED →

DYNABELTER®



11475

PIPE BELT FINISHER



14360

DYNABELTER®



11477



Length	Width	Grit	Item #		Item #		Qty
			Item #	Item #	Item #	Item #	
30" (762 MM)	1/4" (6 mm)	40	79163	•	92175	•	10
		60	79164	•	92176	•	10
		80	79165	•	92177	•	10
		120	•	•	92178	•	10
		180	•	•	•	90471	10
		220	•	•	•	90472	10
		320	•	•	•	90473	10
	1/2" (13 mm)	40	79166	•	92180	•	10
		60	79167	•	92181	90671	10
		80	79168	•	92182	90672	10
		120	•	•	92183	90673	10
		180	•	•	•	90493	10
		220	•	•	•	90494	10
		320	•	•	•	90496	10
	1" (25 mm)	40	79169	•	92185	•	10
		60	79170	•	92186	90674	10
		80	79171	•	92187	90675	10
		120	79158	•	92188	90676	10
		180	•	•	•	90512	10
		220	•	•	•	90513	10
		320	•	•	•	90514	10
	1-1/2" (38 mm)	40	79153	•	92200	•	10
		60	79154	•	92201	90590	10
		80	79155	•	92202	90591	10
		120	79210	•	92203	90592	10
		180	•	•	•	90593	10
		220	•	•	•	90594	10
		320	•	•	•	90595	10
2" (51 mm)	40	79172	•	92190	•	10	
	60	79173	•	92191	90677	10	
	80	79174	•	92192	90678	10	
	120	79159	•	92193	90679	10	
	180	•	•	•	90390	10	
	220	•	•	•	90391	10	
	320	•	•	•	90392	10	

• Call for availability and pricing.

NARROW BELTS 34"-44" COATED ABRASIVES

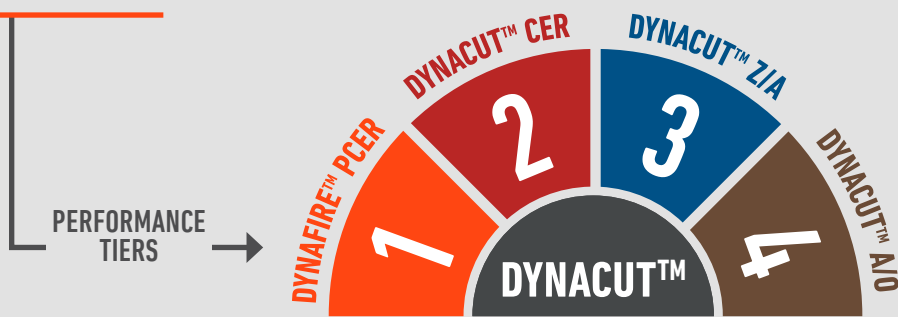

ABRASIVE GRAINS

- Ceramic Alumina (PCER)
- Ceramic Alumina (CER)
- Zirconia Alumina (Z/A)
- Aluminum Oxide (A/O)

TOOLS USED



Length	Width	Grit	Item #	Item #	Item #	Item #	Qty	
34" (864 MM)	1/4" (6 mm)	60	•	•	•	90475	10	
		80	•	•	•	90477	10	
		120	•	•	•	90479	10	
	1/2" (13 mm)	60	•	•	•	90495	10	
		80	•	•	•	90497	10	
		120	•	•	•	90499	10	
	3/4" (19 mm)	60	•	•	•	90367	10	
		80	•	•	•	90368	10	
		120	•	•	•	90370	10	
	2" (51 mm)	2" (51 mm)	36	•	•	90360	•	10
			40	•	•	90362	90376	10
			60	•	•	90363	90377	10
80			•	•	90364	90378	10	
120			•	•	90372	90380	10	
180						90381	10	
220						90375	10	
36" (914 MM)	2" (51 mm)	320				90388	10	
		60	•	•	•	91637	10	
		80	•	•	•	91638	10	
		120	•	•	•	91639	10	
		180				91640	10	
42" (107 CM)	2" (51 mm)	220				91641	10	
		320				91642	10	
		40	•	•	•	81002	10	
		60	•	•	•	81004	10	
		80	•	•	•	81005	10	
		120	•	•	•	81007	10	
		180				81009	10	
44" (112 CM)	1/2" (13 mm)	220				81010	10	
		320				81012	10	
		60	•	•	90544	90545	10	
		80	•	•	•	90547	10	
		120	•	•	•	90549	10	



• Call for availability and pricing.

NARROW BELTS 45", 48" & 60" COATED ABRASIVES

ABRASIVE GRAINS

-  Ceramic Alumina (PCER)
-  Ceramic Alumina (CER)
-  Zirconia Alumina (Z/A)
-  Aluminum Oxide (A/O)

PERFORMANCE TIERS



TOOLS USED

TOOL POST GRINDER

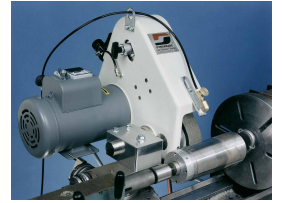

65750

BENCH GRINDER



67900



Length	Width	Grit	Item #	Item #	Item #	Item #	Qty
45" (114 CM)	2" (51 mm)	40	•	•	•	90348	10
		60	•	•	•	90349	10
		80	•	•	•	90350	10
		120	•	•	•	90352	10
48" (122 CM)	2" (51 mm)	60	•	•	91652	91643	10
		80	•	•	91655	91644	10
		120	•	•	91656	91645	10
		180				91646	10
		320				91648	10
60" (152 CM)	2" (51 mm)	80	•	•	•	81033	10
		120	•	•	•	81035	10
		180				81037	10

• Call for availability and pricing.

PEDESTAL STAND

MINIMIZE DOWNTIME & INCREASE EFFICIENCY

- Quick easy height adjustment from 28" to 38" high.
- 1/4" steel tool mount plate and pedestal base.
- 300 lb capacity.



67900 mounted to optional 67500 Pedestal Stand.



67500



67800 mounted to optional 67500 Pedestal Stand.

NARROW BELTS 72" COATED ABRASIVES

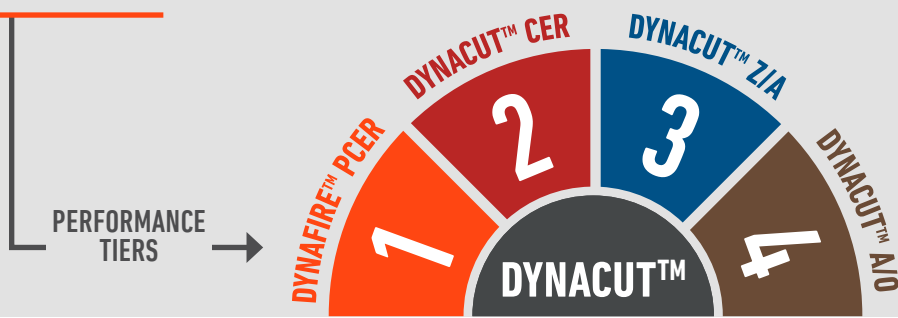

ABRASIVE GRAINS

- Ceramic Alumina (PCER)
- Ceramic Alumina (CER)
- Zirconia Alumina (Z/A)
- Aluminum Oxide (A/O)



Length	Width	Grit	Item #				Qty
			Item #	Item #	Item #	Item #	
72" (183 CM)	1/4" (25 mm)	40	•	•	94807	•	10
		60	•	•	94771	•	10
		80	•	•	94777	•	10
		120	•	•	94789	•	10
		180	•	•	•	94795	10
		220	•	•	•	94801	10
	1/2" (13 mm)	40	•	•	94808	•	10
		60	•	•	94772	•	10
		80	•	•	94778	•	10
		120	•	•	94790	•	10
		180	•	•	•	94796	10
		220	•	•	•	94802	10
	1" (25 mm)	36	•	82646	•	•	10
		40	•	82647	94809	•	10
		50	•	82648	•	•	10
		60	•	82649	94773	•	10
		80	•	82650	94779	•	10
		120	•	82651	94791	•	10
		180	•	•	•	94797	10
		220	•	•	•	94803	10
	1-1/2" (38 mm)	40	•	•	94810	•	10
		60	•	•	94774	•	10
		80	•	•	94780	•	10
		120	•	•	94792	•	10
180		•	•	•	94798	10	
220		•	•	•	94804	10	
2" (51 mm)	36	•	82589	•	•	10	
	40	•	82590	94811	•	10	
	50	•	82591	•	•	10	
	60	•	82592	94775	•	10	
	80	•	82593	94781	•	10	
	120	•	82594	94793	•	10	
	180	•	•	•	94799	10	
	220	•	•	•	94805	10	

VERSATILITY GRINDERS



• Call for availability and pricing.

NARROW BELTS SCALLOPED EDGE BELTS

PERFORMANCE TIERS



ABRASIVE GRAINS

- Ceramic Alumina (PCER)
- Ceramic Alumina (CER)
- Zirconia Alumina (Z/A)
- Aluminum Oxide (A/O)

TOOLS USED



Length	Width	Grit	Item #	Item #	Item #	Item #	Qty
12" (305 MM)	1/2" (13 mm)	60		92152			25
		80		92153			25
		120		92154			25
18" (457 MM)	1/2" (13 mm)	60		92149			25
		80		92150			25
		120		92151			25
24" (610 MM)	1/2" (13 mm)	60		91384			25
		80		91385			25
		120		91386			25
30" (762 MM)	1/2" (13 mm)	60		92174			25

DYNAFILE® II



DYNAFILE®



WHY USE A SCALLOPED EDGE BELT?

Scalloped edge belts blend right angle welds with less undercutting. Seen here the scalloped belt edges conform to the contact wheel of a Dynafile® III (Model 15420) providing consistent coverage as a weld is removed and blended.



NARROW BELTS EXPANDING DRUM BELTS

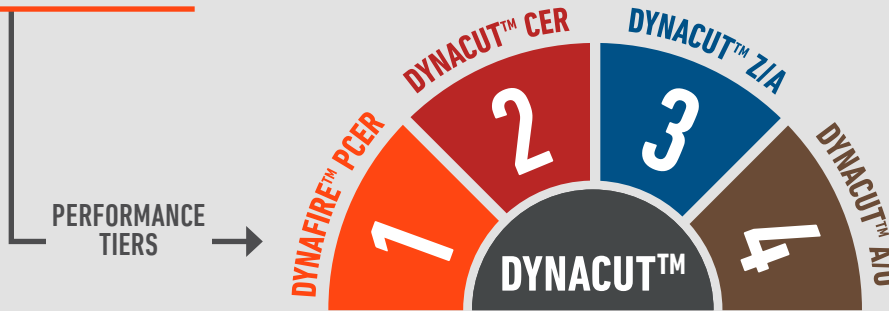

ABRASIVE GRAINS

	Ceramic Alumina (PCER)
	Ceramic Alumina (CER)
	Zirconia Alumina (Z/A)
	Aluminum Oxide (A/O)

TOOLS USED



Length	Width	Grit	Item #	Item #	Item #	Item #	Qty	
7-3/8" (187 MM)	3" (76 mm)	40			90630	•	10	
		60			90631	•	10	
		80			90632	•	10	
		120			90633	•	10	
		180				90634	•	10
		220				90635	•	10
		320				90636	•	10
9-3/4" (248 MM)	2-1/4" (57 mm)	40			92259	•	10	
		60			92260	•	10	
		80			92261	•	10	
		120			92262	•	10	
10-11/16" (271 MM)	3" (76 mm)	40			92100	•	10	
		60			92101	90613	10	
		80			92102	90614	10	
		120			92103	90615	10	
		180				90268	10	
		220				90269	10	
		320				90270	10	
	7" (178 mm)	40				90596	10	
		60				90597	10	
		80				90599	10	
		120				90600	10	
		180				90601	10	
		220				90610	10	
		320				90602	10	

• Call for availability and pricing.

DYNABRADE PNEUMATIC WHEELS

Available in a variety of sizes for use with both coated and non-woven belts in blending, finishing & polishing applications.



TECH TIP

Only inflate pneumatic wheels so the belt fits tightly. Over-inflated wheels cause chatter marks and inferior finishes.

NARROW BELTS EXPANDING DRUM BELTS

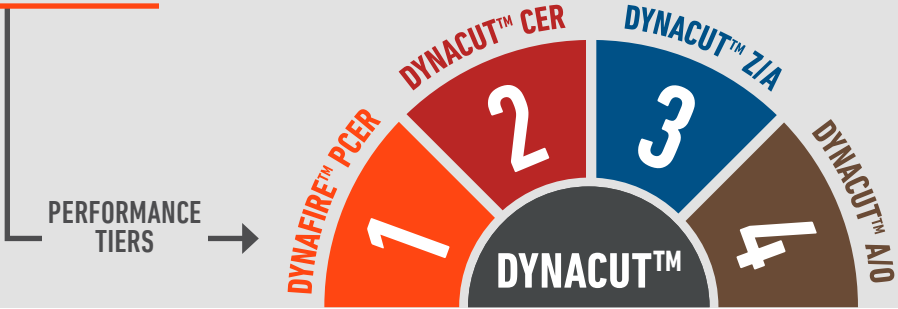

ABRASIVE GRAINS

-  Ceramic Alumina (PCER)
-  Ceramic Alumina (CER)
-  Zirconia Alumina (Z/A)
-  Aluminum Oxide (A/O)

TOOLS USED



13214



DYNISHER

13400

Length	Width	Grit	Item #		Item #	Item #	Item #	Qty
			Item #	Item #				
1" (25 mm)		40	•	•	90194	•	•	50
		60	•	•	90195	•	•	50
		80	•	•	90196	•	•	50
		120	•	•	90197	•	•	50
1-1/2" (39 mm)		40	•	•	90190	•	•	50
		60	•	•	90191	•	•	50
		80	•	•	90192	•	•	50
		120	•	•	90193	•	•	50
2" (51 mm)		40	•	•	90198	•	•	50
		60	•	•	90199	•	•	50
		80	•	•	90200	•	•	50
		120	•	•	90201	•	•	50
2-3/4" (70 mm)		80	•	•	90018	90077	•	10
		120	•	•	90020	90078	•	10
3-1/2" (89 mm)		36	79195	•	90266	90346	•	10
		40	•	•	90267	90347	•	10
		60	79196	•	90272	90353	•	10
		80	79197	•	90273	90354	•	10
		120	79199	•	90275	90355	•	10
		180				90277	•	10
		220				90338	•	10
320				90339	•	10		

• Call for availability and pricing.

DYNAWHEEL PNEUMATIC WHEELS

More rigid than Dynacusion® wheels and are intended for light grinding and deburring applications.



FILM & PAPER DISCS COATED ABRASIVES



DYNACUT™ COATED ABRASIVES

Dynabrade Dynacut™ film and paper discs are available in the widest range of sizes, vacuum hole configurations, attachment types and product performance tiers to meet virtually any blending, sanding, finishing and micro finishing application. Used on Rotary, orbital and random orbital tools in the woodworking, transportation, industrial machinery, metalworking, composites and aerospace markets.

DISCS	21-52
↳ Film & Paper Discs	21-37
↳ Quick Change Discs	38-42
↳ Flap Discs	43-48
↳ Fiber Discs	49-52

FILM & PAPER DISCS PSA & HOOK AND LOOP

For use on rotary and random orbital sanders, Dynabrade offers a wide selection of premium film and paper backed discs. Film & paper discs are offered in individual PSA discs & rolls as well as individual hook and loop discs - in both vacuum and non-vacuum style. DynaCut™ abrasive discs can be used for stripping paint and coatings, sanding plastics, composites, fiberglass and wood, in addition to finishing body filler compounds and gel coats. They are also used in metalworking for preparing bare, primed and painted surfaces, removing rust and scale, light weld blending, decorative finishing, blending and polishing. DynaCut™ discs range in size from 3/4" diameter denibbing discs to 11-1/4" diameter discs for finishing large, flat surfaces. Specialty scalloped edge discs are also available for working flat and contoured surfaces.

DYNACUT™ EXTREME ORANGE CLOG FREE PREMIUM FILM

The BEST choice for the toughest sanding applications.

FEATURES

- 1 Features a premium P graded aluminum oxide abrasive
- 2 Extremely smooth, tough and tear resistant high performance 3mil film backing
- 3 Proprietary clog free coating
- 4 New Extreme vacuum hole pattern

BENEFITS

- For fast cut and long life.
- Generates the finest finishes and up to 4X the life of paper discs.
- Pigment free and "build-up" resistant abrasive surface further extend product life.
- Directs sanding dust to center extraction holes where vacuum draw is greatest.

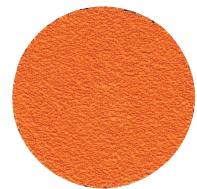

1

DYNACUT™ BLUE ALUMINUM OXIDE CLOG FREE FILM

The BETTER choice for dry finishing on all materials.

FEATURES

- 1 Features a high-performance P graded aluminum oxide abrasive
- 2 Flexible high-performance 3 mil film backing
- 3 Clog free coating

BENEFITS

- For fast cut and consistent finishes.
- Extra smooth finishes and consistently longer life than paper backed discs.
- Provides resistance to loading extending productive life.

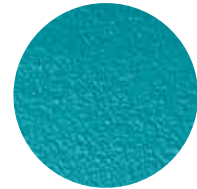

2

DYNACUT™ GOLD ALUMINUM OXIDE CLOG FREE PAPER

The GOOD choice for sanding a variety of surfaces like wood, paint and composites. Available in B-weight and C-weight backings, aluminum oxide paper discs have a clog free coating and are the value choice where price is the only factor.

FEATURES

- 1 Features P graded Aluminum Oxide abrasive
- 2 Resin bond system provides improved grain adhesion
- 3 Tough flexible paper backing
- 4 Special stearate top coating

BENEFITS

- For fast cut and long life.
- Extends disc life.
- Durable and resistant to tearing.
- Provides resistance to clogging of dust and debris.

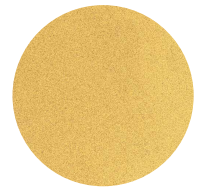

3

FILM & PAPER DISCS PSA & HOOK AND LOOP CONTINUED

4

DYNACUT™ RED ALUMINUM OXIDE HEAVY WT. PAPER

A GOOD choice when a heavier backing and tough abrasives are needed for sanding harder material that does not generally clog the face of the abrasive discs.

FEATURES

- 1 Features a heavy paper backing
- 2 Open Coat P graded aluminum oxide abrasive

BENEFITS

- Resistance to edge shedding on the most demanding material removal and moderate finishing applications.
- Fast removal rates and long life.



5

DYNACUT™ WHITE SILICON CARBIDE CLOG FREE PAPER

The VALUE choice for sanding materials like wood, plastic, composites, glass and for sanding sealers, primers and paint.

FEATURES

- 1 Open coated with extremely sharp silicon carbide abrasive on a smooth B-weight paper backing
- 2 Resin bond system
- 3 Clog free coating

BENEFITS

- Excellent for fine finishing.
- Improves grain adhesion and extends disc life.
- Helps to minimize build-up of sanding dust on the abrasive surface.

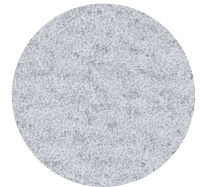

SANDING TECHNIQUES

SWIRL-FREE CHECKLIST

- Always START the sander ON the surface, and STOP the sander OFF the surface.
- When sanding keep the sander; and pad FLAT on the surface. IMPORTANT: Do not exert heavy downward force to keep the back-up pad and abrasive flat on the surface allowing the back-up pad to orbit freely over the surface.
- Follow a set pattern when sanding. It is suggested to pass over the surface, following a “North, South, East, West” pattern (see right), overlapping each pass 1/4 the diameter of the back-up pad and abrasive. This insures that the previous scratches are removed and that a uniform finish is achieved. Two “patterns” per sanding step are recommended.
- Frequently inspect abrasive for tears, folds, or build-up. When changing abrasive to proceed to the next sanding step, first inspect the condition of the abrasive that is on the sander. If any defects are noticed in that abrasive, remove it and install another piece of the same grain and sand the work surface again before proceeding on to the next sanding step.
- Always clear away sanding dust and abrasive debris before progressing to the next sanding step with a finer “grit” abrasive.

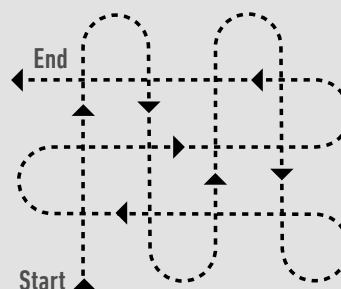

A/O PAPER DISCS 3/4" & 1-1/4" PSA NON-VACUUM DISCS

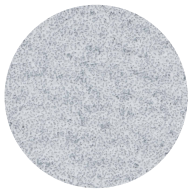

Dia.	Grit	Backing	Item #	Item #	Item #	Item #	Item #	Qty/Bag
3/4" (19 MM)	80	Paper					78160	75
	120						78161	75
	180						78162	75
	220						78163	75
1-1/4" (32 MM)	80	Paper					78165	25
	120						78166	25
	180						78167	25
	220						78168	25



MINI-DYNORBITAL® SANDING PADS



NOTE: To mount pads that have 1/4"-20 female thread directly to tool for conventional rotary action, use 54021 adapter.

Dia.	Material	Thread	Density	Face	Item #
3/4" (19 MM)	Foam	1/4"-20 Female	Medium	Rubber	54017
			Very Soft	Foam	54085
			Soft	Vinyl	54087
	Nylon		Hard	Hook	54089
	Urethane		Soft	Vinyl	54091
1-1/4" (32 MM)	Foam	1/4"-20 Female	Medium	Rubber	54018
	Nylon	Locking Type	Soft	Vinyl	54037
	Urethane		Soft	Vinyl	54084
	Foam	1/4"-20 Female	Very Soft	Foam	54086
			Soft	Vinyl	54088
	Nylon		Hard	Hook	54090

A/O FILM & PAPER DISCS 3-1/2" & 5" PSA NON-VACUUM DISCS

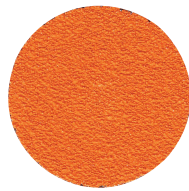
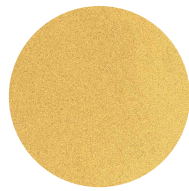

Dia.	Grit	Backing	Item #	Item #	Item #	Item #	Item #	Qty/Box
3-1/2" (89 MM)	80	Paper			79900			100
	120				79901			100
	150				79905			100
	180				79902			100
	220				79903			100
	320				79904			100
5" (127 MM)	60	Film		82454				100
		Paper	91526		79967			50
	80	Film		82455				100
		Paper	91527		79910			50
	100	Film		82456				100
		Paper	91528					50
	120	Film		82457				100
		Paper	91529		79911			50
	150	Film		82458				100
		Paper	91530		79914			50
	180	Film		82459				100
		Paper	91531		79912			50
	220	Paper		79913				100
		Film	91532					50
	240	Film		82460				100
		Paper		79007				100
	320	Film		82461				100
		Paper	91533		79981			50
	400	Film		82462				100
		Paper	91534					50

3-1/2", NON-VACUUM DYNORBITAL® SUPREME



5" DYNORBITAL® EXTREME



A/O FILM & PAPER DISCS 5" PSA VACUUM HOLE DISCS



Dia.	Grit	Backing	Item #	Item #	Item #	Item #	Item #	Std. Pkg.
5" (127 MM)	40	Paper					79987	100
		Film		82465				100
	60	Paper					79968	100
		Film		82466				100
	80	Paper					79915	100
		Film		82467				100
	120	Film		82468				100
		Paper					79916	100
	150	Film		82469				100
		Paper					79919	100
	180	Film		82470				100
		Paper					79917	100
	220	Paper					79918	100
		Film		82471				100
	240	Film		82472				100
		Paper					79982	100
320	Paper					79908	100	
	Film		82473				100	
400	Film						100	

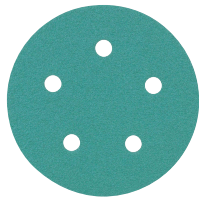

5" DYNORBITAL-SPIRIT®



VINYL-FACE DISC PADS



Dia.	Holes	Thickness	Density	Item #
5" (127 MM)	5	3/8"	Soft	56100
			Medium	56104
		5/8"	Medium	56176
			Soft	56186
	6	3/8"	Medium	56241
		5	1/2"	Extra Soft
5" CHANNEL VAC.	5	3/8"	Soft	56251
			Medium	56252
		5/8"	Soft	56254
			Medium	56256

Dynabrade single-piece hub design leads to less vibration. Less vibration relieves stress on an operator's hand and arm & extends bearing life.



A/O FILM & PAPER DISCS 6" PSA NON-VACUUM DISCS



Dia.	Grit	Vacuum Type	Backing	Item #	Item #	Item #	Item #	Item #	Qty/Box
6" (152 MM)	60	Non-Vacuum	Film	82476					100
			Paper	91553			79977		50
	80	Non-Vacuum	Film	82477					100
			Paper	91554			79920		50
	100	Non-Vacuum	Film	82478					100
			Paper	91555					50
	120	Non-Vacuum	Film	82479					100
			Paper	91556			79921		50
	150	Non-Vacuum	Film	82480					100
			Paper	91557			79924		50
	180	Non-Vacuum	Film	82481					100
			Paper	91558			79922		50
	220	Non-Vacuum	Film	91559			79923		50
			Paper			79923		100	
	240	Non-Vacuum	Film	82482					100
			Paper	91560					50
	320	Non-Vacuum	Film	82483					100
			Paper			79931		100	
	400	Non-Vacuum	Film	91561					50
			Paper		82484				100

6" DYNORBITAL® SILVER SUPREME



6" DYNORBITAL-SPIRIT®

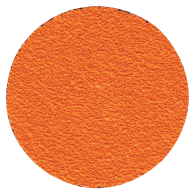

DYNORBITAL® SANDING PADS



Dia.	Thickness	Nap	Density	Item #
6" (152 MM)	3/8"	Short	Medium	54327
			Soft	56158
	5/8"		Medium	56182
			Soft	56197

A/O FILM & PAPER DISCS 6" PSA VACUUM HOLE DISCS

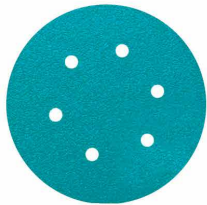

Dia.	Grit	Backing	Item #	Item #	Item #	Item #	Item #	Qty/Box
6" (152 MM)	60	Film		82487				100
		Paper					79978	100
	80	Film		82488			79925	100
		Paper					79925	100
	100	Film		82489				100
	120	Film		82490				100
		Paper					79926	100
	150	Film		82491				100
		Paper					79929	100
	180	Film		82492				100
		Paper					79927	100
	220	Paper					79928	100
	240	Film		82493				100
		Film		82494				100
320	Film					79932	100	
400	Film		82495				100	

6" DYNORBITAL® EXTREME



6" DYNORBITAL® SUPREME



VINYL-FACE DISC PADS



Dia.	Holes	Thickness	Density	Item #
6" (152 MM)	6	3/8"	Soft	56101
			Medium	56105
		5/8"	Medium	56178
			Soft	56188
6" CHANNEL VAC.	6	3/8"	Soft	56261
			Medium	56262
		5/8"	Medium	56264
			Soft	56266

FASTER SANDING, FINER FINISHES AND LOWER COSTS!

Dynabrade Random Orbital Sanding Pads are precision engineered for **ULTRA-SMOOTH** performance and **LONGER LIFE!**



A/O PAPER DISCS 8" PSA NON-VACUUM DISCS & VACUUM HOLE DISCS

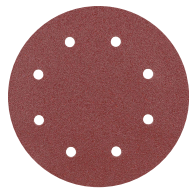

Dia.	Grit	Vacuum Type	Backing	Item #	Item #	Item #	Item #	Item #	Qty/Box
8" (203 MM)	80	Vacuum	Paper					91249	25
	120							91251	25
	150							91244	25
	180							91245	25
	220							91246	25
	320							91248	25
	60	Non-Vacuum	Paper					91236	25
	80							91237	25
	120							91239	25
	150							91240	25
	180							91241	25
	220							91242	25
	320						91243	25	



8" RANDOM ORBITAL PADS

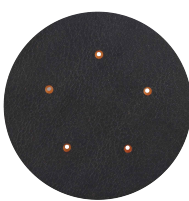

Dia.	Vacuum Type	Face	Holes	Thickness	Density	Item #	
8" (203 MM)	Non-Vacuum	Vinyl		3/8"	Medium	56234	
	Vacuum 5-Hole		-			56235	
	Non-Vacuum	Hook				56236	
	Vacuum	-		48	3/8"	Medium	56322
				8			56327



* 8" Pads mount to Two-hand and Gear-driven sanders using 5 screws.

A/O PAPER DISC ROLLS PSA NON-VACUUM & VACUUM DISC ROLLS



Dia.	Grit	Vacuum Type	Backing	Item #	Item #	Item #	Item #	Item #	Qty/Roll
3-1/2" (89 MM)	80	Non-Vacuum	Paper			79230			100
	120					79231			100
	150					79235			100
	180					79232			100
	220					79233			100
	320					79234			100
5" (127 MM)	80	Non-Vacuum	Paper			79240			100
	120					79241			100
	150					79246			100
	180					79242			100
	220					79243			100
	80			Vacuum	Paper			79245	
120			79247					100	
150			79248					100	
180			79249					100	
220			79250					100	
6" (152 MM)	80	Non-Vacuum	Paper					79252	
	120					79254			100
	150					79255			100
	180					79256			100
	220					79257			100
	80	Vacuum	Paper			79259			100
	120					79261			100
	150					79262			100
	180					79263			100
	220					79264			100



3-1/2" DYNORBITAL® SUPREME



5" DYNORBITAL® EXTREME



6" DYNORBITAL-SPIRIT®



VINYL-FACE RANDOM ORBITAL SANDING PADS

Dia.	Thickness	Attachment	Density	Vacuum Type	Item #
3-1/2" (89 MM)	5/8"	PSA	Medium	Non-Vacuum	56097
			Soft		56098



Dia.	Thickness	Attachment	Density	Vacuum Type	Item #
5" (127 MM)	3/8"	PSA	Soft	Non-Vacuum	56102
			Medium		56106
	5/8"		Medium		56175
			Soft		56185
	1/2"		Extra Soft		56273

A/O FILM & PAPER DISCS HOOK & LOOP VACUUM AND NON-VACUUM DISCS



Dia.	Grit	Vacuum Type	Backing	Item #	Item #	Item #	Item #	Item #	Qty/Box		
3" (76 MM)	60	Non-Vacuum	Film		92074				50		
	80				92075				50		
	120				92076				50		
	150				92077				50		
	180				92078				50		
	220				92079				50		
	320				92080				50		
	60			Vacuum	Paper			92081			50
	80							92056			50
	120							93665			50
150			92057					50			
180			93666					50			
220			92082					50			
320			93667					50			
60	Vacuum	Paper								50	
80										50	
120										50	
150								50			
180								50			
220								50			
320								50			
3-1/2" (89 MM)	80	Vacuum	Paper						100		
	120								100		
	150								100		
	180								100		
	220								100		
	320								100		

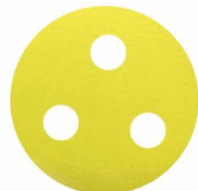

NON-VAC. DYNORBITAL-SPIRIT®



HIVAC DYNORBITAL-SPIRIT®



DYNORBITAL® SANDING PADS



Dia.	Thickness	Nap	Density	Item #
3"	5/8"	Short	Medium	56087
		Long		56090
	1/2"	Short	56145	



Dia.	Thickness	Nap	Density	Item #
3-1/2"	5/8"	Short	Soft	54311
		Short	Hard	54313
		Long	Medium	54314

A/O FILM & PAPER DISCS 5" HOOK & LOOP NON-VACUUM DISCS



Dia.	Grit	Backing	Item #	Item #	Item #	Item #	Item #	Qty/Box
5" (127 MM)	60	Film	91544	82427				50
		Paper			79969			100
	80	Film	91545	82428				50
		Paper			79941			100
	100	Film	91546	82429				50
		Paper						100
	120	Film	91547	82430				50
		Paper			79942			100
	150	Film	91548	82431				50
		Paper			79945			100
	180	Film	91549	82432				50
		Paper			79943			100
	220	Film	91550					50
		Paper			79944			100
	240	Film		82434				100
		Paper						100
	320	Film	91551	82435				50
		Paper			79909			100
	400	Film	91552					50
		Paper		82436				100

5" DYNORBITAL® EXTREME



5" DYNORBITAL® SUPREME



5" DYNORBITAL-SPIRIT®



DYNORBITAL® SANDING PADS



Dia.	Thickness	Nap	Density	Item #	
5" (127 MM)	3/8"	Short	Medium	54325	
			Soft	56157	
	5/8"		Medium	56180	
			Soft	56195	
	1/2"		Extra Soft	Medium	56271
				Soft	56271

Dynabrade single-piece hub design leads to less vibration. Less vibration relieves stress on an operator's hand and arm & extends bearing life.



A/O FILM & PAPER DISCS 5" HOOK & LOOP VACUUM HOLE DISCS



Dia.	Grit	Backing	Item #	Item #	Item #	Item #	Item #	Qty/Box
5" (127 MM)	40	Paper			79989*			100
		Film	91535					50
	60	Paper		79359				100
		Film	91536			79976*		50
	80	Paper				79961		100
		Film		79360		79946*		100
	100	Film	91537					50
		Paper		79361				100
	120	Film	91538					50
		Paper		79362		79962		100
	150	Paper				79947*		100
		Film	91539					50
	180	Paper		79363		79963		100
		Film				79950*		100
	220	Film	91540					50
		Paper		79364		79964		100
	240	Film				79948*		100
		Paper	91541					50
	320	Paper				79965		100
		Film		79366		79949*		100
400	Film	91542					50	
	Paper		79367		79966		100	
400	Film				79930*		100	
	Paper	91543					50	
				79368			100	

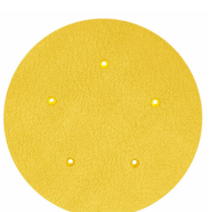
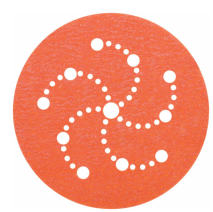

* 5-Hole.

All items are Multi-Hole, unless otherwise indicated. * Indicates 5-Hole.

5" DYNORBITAL® EXTREME



5" DYNORBITAL® SUPREME



5" DYNORBITAL-SPIRIT®



A/O FILM & PAPER DISCS 6" HOOK & LOOP NON-VACUUM DISCS



Dia.	Grit	Backing	Item #	Item #	Item #	Item #	Item #	Qty/Box
6" (152 MM)	60	Film	91571	82442				50
		Paper			79979			100
	80	Film	91572	82443				50
		Paper			79951			100
	100	Film	91573	82444				50
								100
	120	Film	91574	82445				50
		Paper			79952			100
	150	Film	91575	82446				50
		Paper			79955			100
	180	Film	91576	82447				50
		Paper			79953			100
	220	Film	91577					50
		Paper			79954			100
	240	Film		82449				100
								100
320	Film	91578	82450				50	
	Paper			79933			100	
400	Film	91579					50	
			82451				100	

6" DYNORBITAL® EXTREME



6" DYNORBITAL® SUPREME



6" DYNORBITAL-SPIRIT®



DYNORBITAL® SANDING PADS



Dia.	Thickness	Nap	Density	Item #
6" (152 MM)	3/8"	Short	Medium	54327
			Soft	56158
	5/8"		Medium	56182
			Soft	56197
	3/8"	Short	Medium	54339

A/O FILM & PAPER DISCS 6" HOOK & LOOP VACUUM HOLE DISCS

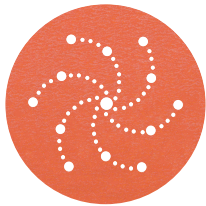

Dia.	Grit	Backing	Item #	Item #	Item #	Item #	Item #	Qty/Box
6" (152 MM)	60	Film	91563	79374				50
		Paper			79980*			100
	80	Film	91563	79375				50
		Paper			79970*			100
	100	Film	91564	79376				50
		Paper			79956*			100
	120	Film	91565	79377				50
		Paper			79971*			100
	150	Film	91566	79378				50
		Paper			79972*			100
	180	Film	91567	79379				50
		Paper			79973*			100
	220	Film	91568	79974	79959*			50
		Paper			79958*			100
	240	Film	91569	79382				50
		Paper			79975*			100
	320	Film	91570	79383				50
		Paper			79934*			100
	400	Film						50
		Paper						100

6" DYNORBITAL® EXTREME



6" DYNORBITAL® SUPREME



6" DYNORBITAL-SPIRIT®



All items are Multi-Hole, unless otherwise indicated. * Indicates 6-Hole.

A/O FILM & PAPER DISCS 8" & 11-1/4" HOOK & LOOP NON-VACUUM DISCS



Dia.	Grit	Backing	Item #	Item #	Item #	Item #	Item #	Qty/Box
8" (203 MM)	40	Paper					91444	25
	80						91446	25
	120						91448	25
	150						91250	25
	180						91252	25
	220						91253	25
	320						91254	25
11-1/4" (286 MM)	36	Paper					91315	10
	60						91616	10
	80						91300	10
	120						91301	10
	180						91302	10

8" TWO-HAND DYNORBITAL®



11" TWO-HAND DYNORBITAL®



DYNORBITAL® & GEAR-DRIVEN SANDING PADS



Dia.	Thickness	Nap	Density	Item #
8"	3/8"	Short	Medium	56236
11"	1/2"	Short	Medium	56231



A/O FILM & PAPER DISCS 8" & 11-1/4" HOOK & LOOP VACUUM HOLE DISCS

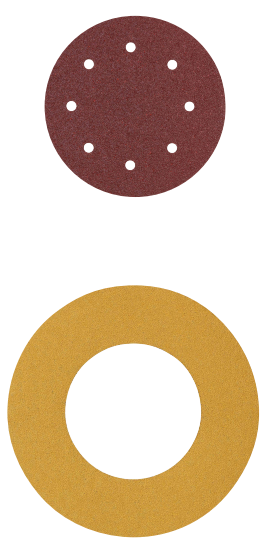

Dia.	Grit	Backing	Item #	Item #	Item #	Item #	Item #	Qty/Box
8" (203 MM)	40	Paper					91456	25
	60						91457	25
	80						91458	25
	120						91460	25
	150						91255	25
	180						91256	25
	220						91257	25
	320						91258	25
11-1/4" (286 MM)	36	Paper				91317		10
	60					91318		10
	80					91303		10
	120					91304		10
	180					91309		10
	220					91305		10
					91306		10	

8" TWO-HANDED DYNORBITAL®



11" TWO-HANDED DYNORBITAL®



A/O MICROFINISHING DISCS

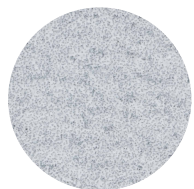

Dia.	Grit	Attachment	Backing	Item #	Qty/Box
3-1/2" (89 MM)	60μ	Hook and Loop Non-Vacuum	Film	92582	50
	100μ			92583	
5" (127 MM)	30μ	Hook and Loop Non-Vacuum	Film	92594	50
	60μ			92593	
	80μ			92587	
	100μ			92592	
11-1/4" (286 MM)	15μ	Hook and Loop Vacuum	Film	91325	10
	30μ			91326	
	60μ			91327	
	80μ			91328	
	100μ			91329	

TECH TIP

When using gear-driven orbital sanders lubricate gears every 8 hours of use.



QUICK CHANGE DISCS

COATED ABRASIVES

COATED QUICK CHANGE DISCS

Dynabrade Dynacut™ coated abrasive “locking type” quick change discs are offered in the most common attachment style that provides twist on, twist off convenience to maximize production time. Available in three performance tiers to provide the lowest total cost on a wide range of applications.

DISCS	38-42
↳ Quick Change Discs	38-42

COATED QUICK CHANGE DISCS CLOTH DISCS

Quick-change discs provide tool-free fastening with a “twist on, twist off” feature that makes changing small diameter discs fast and efficient to maximize productivity and reduce downtime. Used with right angle mini-grinders DynaCut™ quick change discs are ideal for weld grinding and blending, from heavy metal removal to light deburring and finishing on flat and contoured surfaces. Available in 2", 3" and 4" diameters with grit sizes from 24 through 120 grit and TR style attachment.

1

DYNAFIRE™ PCER CERAMIC CLOTH DISCS

The PREFERRED choice for the toughest applications on mild and carbon steel, stainless steel, cobalt, chrome, Inconel and titanium.

FEATURES

- 1 Next generation ceramic alumina grain
- 2 Heavy-duty, 3-ply, laminated cloth backing

BENEFITS

- Is a supersize grinding aid for the coolest cut and fastest cut rates.
- Provides the most aggressive action and has the highest durability and longest life. Also provides excellent edge fray resistance during the toughest applications.



2

DYNACUT™ CER CERAMIC CLOTH DISCS

The BEST choice for mild and carbon steel, stainless steel, cobalt, chrome, Inconel and titanium.

FEATURES

- 1 Self-sharpening high performance ceramic abrasive
- 2 Cool-cutting, top-size technology
- 3 Sturdy, Y-weight, cloth backing

BENEFITS

- Provides high stock removal rates and longer product life.
- Reduces heat at the grinding interface, increasing performance and production.
- Offers reliable performance on a wide range of tough grinding, blending and finishing applications.



3

DYNACUT™ Z/A ZIRCONIA ALUMINA CLOTH DISCS

The BETTER choice for soft metals, stainless steel and carbon steel.

FEATURES

- 1 Premium self-sharpening zirconia alumina abrasive
- 2 Strong resin bond system
- 3 Durable, Y-weight, polyester backing

BENEFITS

- Self-lubricating top size that generates an aggressive, cool and rapid cut rate.
- Provides excellent grain adhesion, reducing grain shedding.
- Holds up to demanding applications, including high pressure grinding on hard-to-grind alloys.

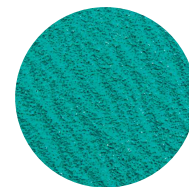

4

DYNACUT™ A/O ALUMINUM OXIDE CLOTH DISCS

A GOOD choice where price is the initial consideration. Used for light to heavy grinding and blending on aluminum, carbon steel, brass and bronze.

FEATURES

- 1 Tough, durable aluminum oxide
- 2 The durable 2-ply, X-weight cloth

BENEFITS

- Provides aggressive cut and long life.
- Ensures reliable performance in moderately demanding applications and provides long usable life.



COATED QUICK CHANGE DISCS LOCKING-TYPE DISCS



Dia.	Grit	Backing	Item #	Item #	Item #	Item #	Qty/Box
2" (51 MM)	36	2 Ply Cloth		92025	78098	78190	25
		3 Ply Cloth	78103				25
	50	2 Ply Cloth		92084	78099	78191	25
		3 Ply Cloth	78111				25
	60	2 Ply Cloth		92027	78100	78192	25
		3 Ply Cloth	78112				25
	80	2 Ply Cloth		92028	78101	78193	25
		3 Ply Cloth	78113				25
120	2 Ply Cloth		92029	78102	78194	25	
	3 Ply Cloth	78114				25	
3" (76 MM)	36	2 Ply Cloth		92086		78195	25
		3 Ply Cloth	93092				25
	50	2 Ply Cloth		92087		78196	25
		3 Ply Cloth	93093				25
	60	2 Ply Cloth		92031	78104	78197	25
		3 Ply Cloth	93094				25
	80	2 Ply Cloth		92032	78105	79198	25
		3 Ply Cloth	93095				25
120	2 Ply Cloth		92033	78106	79199	25	
	3 Ply Cloth	93096				25	
4" (102 mm)	36	2 Ply Cloth			78108	25	
	60				78109	25	
	80				78110	25	
	120				78129	25	

2" RIGHT ANGLE DISC SANDER



3" DIA, 7° DISC SANDER



4" RIGHT ANGLE DISC SANDER



PADS FOR QUICK-CHANGE DISCS

- 2" (51 mm), 3" (76 mm) and 4" (102 mm) diameter pads available.
- A quick turn of the disc locks it into place.
- 2" (51 mm) and 3" (76 mm) dia. pads include 50103 Pad Adapter to convert 1/4"-20 female thread to 1/4" dia. shank, for use with Collets and Chucks.

*Includes 50103 Pad Adapter to convert 1/4"-20 female thread to 1/4" dia. shank for use with collets and chucks.

Pad Dia.	MOS RPM	Thread	Density	Item #
2" (51 MM)	30,000	1/4"-20 Female	Medium	51348*
		3/8"-24 Female		51345
3" (76 MM)	20,000	1/4"-20 Female	Medium	51346*
		3/8"-24 Female		51347
4" (102 MM)	12,000	3/8"-24 Female	Medium	50191
			Hard	50192



COATED QUICK CHANGE DISCS LOCKING-TYPE DISCS

GEARED → Heavy stock removal applications generally require aggressive abrasive discs and tools that deliver torque under load. Dynabrade manufactures right angle geared tools for these types of applications. Geared tools tend to run more slowly than gearless tools but maintain rotation when heavy downward pressure is applied. Dynabrade offers geared tools ranging from .4 hp to 2.8 hp.

.4 HP DISC SANDER



.7 HP DISC SANDER



1.3 HP DISC SANDER



GEARLESS → Blending applications typically require finer grit abrasive discs and tools that can finish quickly and efficiently. Dynabrade manufactures gearless disc sanders for these applications. Gearless tools generally operate at higher speeds, are more quiet and have fewer parts to maintain when productivity is key. Dynabrade offers gearless disc sanders ranging from .4 hp to 3 hp.

.4 HP GEARLESS DISC SANDER



3" DISC SANDER



.7 HP PISTOL GRIP DISC SANDER



APPLICATION GRIT GUIDE

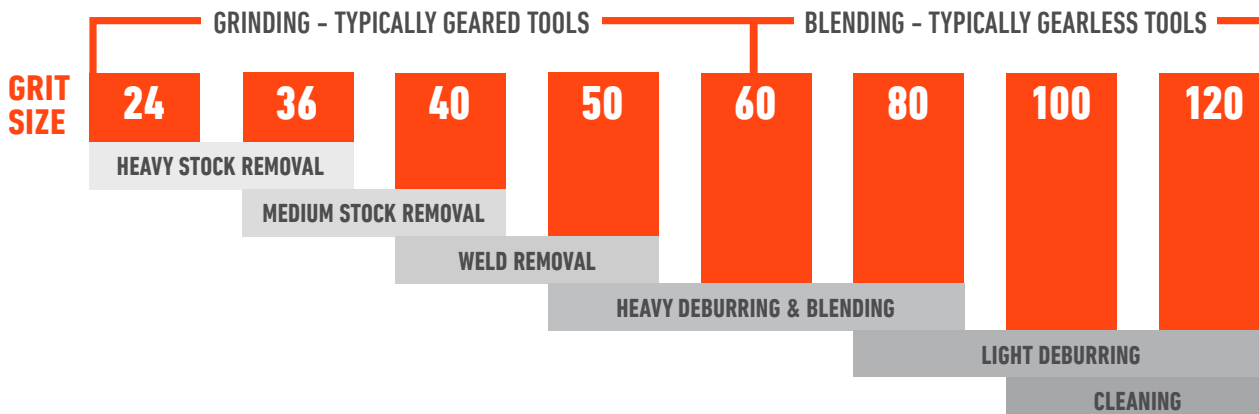

PRODUCT RECOMMENDATION GUIDE

	HIGHEST PERFORMANCE LOWEST TOTAL COST		PERFORMANCE PRICE VALUE	GENERAL DUTY LOW PRICE
	1	2	3	4
	DYNAFIRE™ PCER	DYNACUT™ CER	DYNACUT™ Z/A	DYNACUT™ A/O
CARBON STEEL / WELDS	•	•	•	•
STAINLESS / EXOTIC ALLOYS	•	•	•	•
CAST IRON / FERROUS METALS	•	•	•	•
ALUMINUM / BRONZE / BRASS			•	•
PAINT & ADHESIVES				•

COMPETITOR CROSS REFERENCE

PERFORMANCE ABRASIVE MINERAL BACKING

	PERFORMANCE ←		PRICE →	
	DYNAFIRE™ PCER 3 Ply Ywt. Cloth	DYNACUT™ CER 2 Ply Ywt. Cloth	DYNACUT™ Z/A 2 Ply Xwt. Cloth	DYNACUT™ A/O 2 Ply Xwt. Cloth
 NORTON	Blaze R980P		Blue Fire R884P	Merit A/O
3M	963G, 977F, 785C, 777F			361F
SUPERIOR	Ceramics G.A.		Premium Zirc	Premium A/O Rigid Kut A/O
STANDARD	Ceramic Pro	Ceramic	Zirconia	A/O
PFERD		Ceramic Oxide CO-COOL	Zirconia Alumina Z	Aluminum Oxide A, A-Flex, A-Plus, A-Cool
SAIT			Zirconia	3A, 2A-H, 2A
CAMEL			Zirconia A/O	Aluminum Oxide
ARC			Zirconia/ Y Standard	A/O Y Premium
KLINGSPOR		Ceramic	Alumina Zirconia	Aluminum Oxide
GARRYSON		Ceramic		Aluminum Oxide

FLAP DISCS COATED ABRASIVES



COATED FLAP DISCS

The Dynabrade Dynacut™ line of coated abrasive flap discs provides a range of grinding and finishing solutions. Combining coated abrasive flaps, a backing plate and shape, the different variations cover a wide array of applications from heavy grinding and stock removal to blending and finishing. Used on portable right angle grinders, flap discs are often the preferred choice versus fiber discs with up to 20X the life versus fiber discs.

DISCS	43-48
↳ Flap Discs	43-48

FLAP DISCS LOCKING-TYPE & THREADED HUBS

Flap Discs are one of the most versatile grinding and finishing abrasives for applications ranging from heavy stock removal to surface blending and finishing. Flaps discs have three components – a backing plate, adhesive and coated abrasive cloth flaps. Small coated abrasive rectangles are concentrically placed on the backing and glued in place, overlapping each other to form a layered abrasive disc.

Designed for use on right angle grinders, flap discs can grind, blend and finish in one operation which can often replace the traditional two-step process of grinding with a type 27 grinding wheel then finishing with a resin fiber disc. Flap discs by their design, are easier to control, are cooler cutting and offer faster removal with more consistent finishes versus type 27 grinding wheels that vibrate more, are louder and contribute to operator fatigue.

Compared to fiber discs, flap discs can last up to 20 times longer or more and have a self-sharpening action from the multi-layered flaps. Additional benefits of flap discs are that they do not require a back-up pad and are not impacted by humidity making them easier to store and more reliable to use.

Flap discs are available in mini sizes, 2" and 3" diameter, with TR style locking attachment for disc sanders and die grinders. Traditional 4", 4-1/2", 5" and 7" diameters in type 27 flat and type 29 conical shapes are bonded to fiberglass or trimmable backplates with 7/8" arbor and 5/8"-11 Hubbed for use right angle grinders. Flap disc applications include grinding, stock removal, edge chamfering, weld blending, deburring, rust removal and cleaning, finishing and polishing to mirror finish. Grit rage is 36, 40, 60, 80 and 120 coated abrasive and wool felt for final polishing applications.

DYNAFIRE™ PCER

The PREFERRED choice for mild and carbon steel, stainless steel, cobalt chrome, Inconel and Titanium.

FEATURES

- 1 Features high performance Ceramic Alumina grain with a special grinding aid
- 2 Heavy-duty polyester cloth flaps
- 3 Fiberglass backing on T27 and T29
- 4 Plastic Trimmable backplates on T27 5/8-11 hub

BENEFITS

- Cuts cooler, 20% faster and lasts up to 2X longer than aluminum oxide abrasives.
- Provides excellent fray resistance.
- High-strength, lightweight and absorbs vibration.
- Allows for trimming of the back plate to continuously expose flap edges as flap disc wears.



1

DYNACUT™ Z/A ZIRCONIA

The BETTER choice when grinding and finishing a wide variety of materials like mild carbon steel and stainless steel, aluminum, fiberglass and plastics.

FEATURES

- 1 Premium, self-sharpening zirconia alumina abrasive
- 2 High strength backing provides
- 3 2" and 3" quick change mini flap discs with TR attachment

BENEFITS

- Generates an aggressive and rapid cut rate and up to 30% longer life than competitive flap discs.
- Excellent grain adhesion, edge fray resistance and absorbs vibration.
- Perfect for hard to reach and tight spaces.

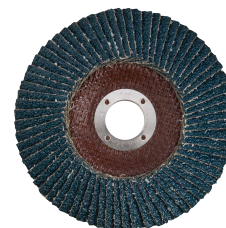

2

DYNACUT™ A/O ALUMINUM OXIDE

The GOOD choice for consistency performance on aluminum, bronze, stainless and carbon steel.

FEATURES

- 1 Tough, durable aluminum oxide for general purpose light to medium duty grinding on a wide range of ferrous and non-ferrous metals
- 2 A durable, X-weight cloth backing

BENEFITS

- Effective for blending on aluminum, carbon steel, brass and bronze.
- Ensures optimum performance and long useable life.



3

FLAP DISC BACKING PLATES LOCKING-TYPE & THREADED HUBS

The backing plate provides the support and basic shape (flat or conical) for the abrasive flaps. The abrasive flaps and fiberglass backing plate are designed to wear together during continuous grinding and finishing applications. Wearing together allows for efficient use of the maximum amount of the abrasive flaps and is why fiberglass backing plates are the most commonly used.

Trimmable plastic backing plates enable the operator to use more of the flaps by continuously trimming the backing plate as the flaps wear reducing disc changes and waste, saving time and increasing life. Trimmable backing plate flap discs also allow operators access to hard to reach areas like fillet welds and other irregular shapes while also grinding on edge without having to change tools and or abrasives

SHAPES

Flat Backing Plate & Coated Flaps - The BEST shape for finishing

TYPE 27

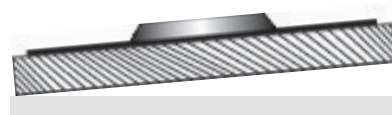

- Grind at a 10-15° angle.
- Narrow point of contact.
- Best used for blending and finishing.

Conical Reverse Curved Backing plate & Coated Flaps - The BEST shape for aggressive stock removal

TYPE 29

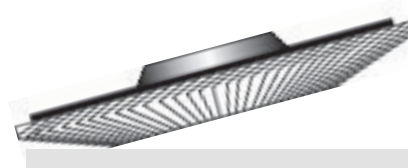

- Angled flaps grind at a 15-25° angle without excessive operator manipulation.
- Good for both flat and contoured surfaces.
- Angled abrasive flaps allow for larger surface area contact for high-stock removal on flat surfaces.
- Excellent choice when high speed stock removal is the primary consideration.

MATERIAL TO PRODUCT RECOMMENDATION GUIDE

	1 STOCK REMOVAL	2	3 BLENDING & FINISHING
	DYNAFIRE™ PCER	DYNACUT™ Z/A	DYNACUT™ A/O
STAINLESS STEEL / SUPER ALLOYS	•	•	•
MILD CARBON STEEL / WELDS	•	•	•
FERROUS METALS	•	•	•
NON-FERROUS METALS		•	•
FIBERGLASS / PLASTICS			•

APPLICATION GRIT GUIDE

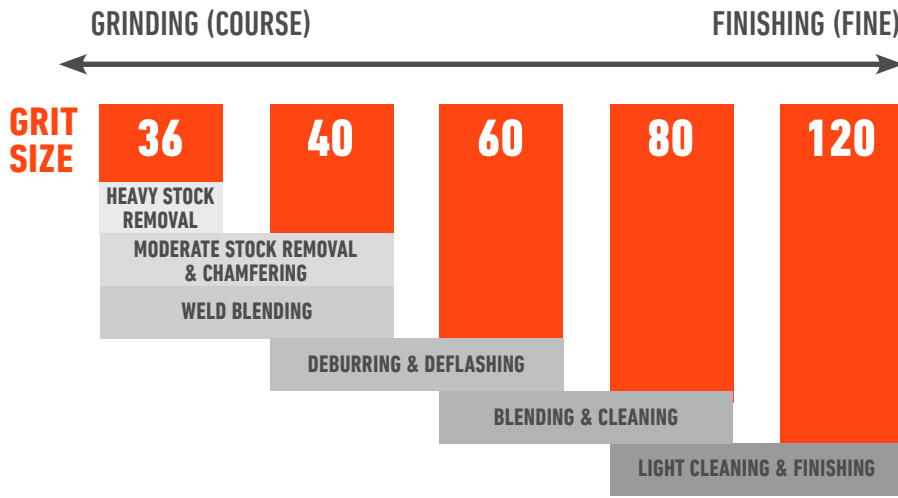

COMPETITOR CROSS REFERENCE

	PERFORMANCE		PRICE
	DYNAFIRE™ PCER	DYNACUT™ Z/A	DYNACUT™ A/O
3M	967A Cubitron II 969F Cubitron	577F, 546D, 566A	-
NORTON	R980P, R983	R828	-
CAMEL	C3	Z3	A3
GEMTEX	Ceramic	Zirconia	Aluminum Oxide
KLINGSPOR	SMT966	SMT628, SMT624	SMT627
PEARL	Red Line CB, Stainless Max	Zirconia Premium, TuffMax	-
PFERD	CO-Cool Cut, Ceramic	Zirconia	-
STANDARD	Ceramic Oxide	Zirconia	-
WALTER	Enduro Flex Stainless	Flex Steel	Enduro Flex
WEILER	Sabre Tooth Ceramic	Tiger	Wolverine

COATED FLAP DISCS DYNACUT™ MINI LOCKING-TYPE FLAP DISCS

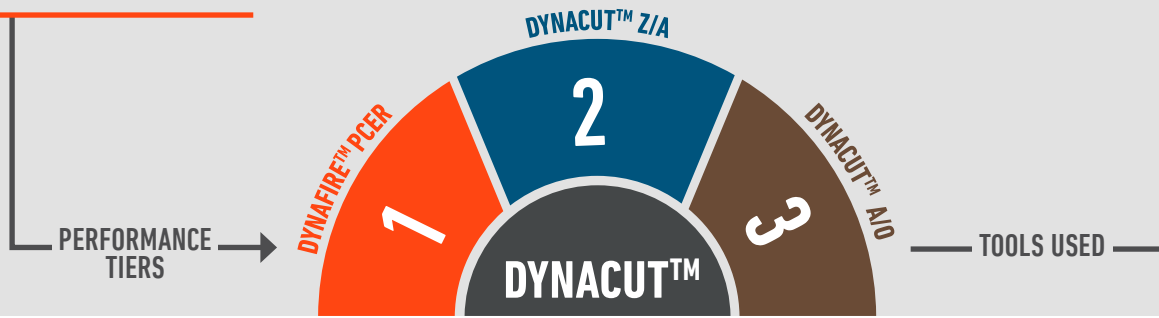

Dia.	Grit	Shape	Item #	Item #	Item #	Qty
2" (51 MM)	40	TR		90970		10
	60			90971		10
	80			90972		10
	120			90973		10
3" (76 MM)	40	TR		90924		10
	60			90925		10
	80			90926		10
	120			90927		10



DEPRESSED CENTER WHEEL GRINDERS

WELD PREPARATION & REMOVAL



- Accepts a wide variety of abrasives like Type 27 bonded products, fiber discs and layered flap discs.
- Ergonomic design of tool offers the best in operator comfort.
- This tool has a powerful 1.3 hp air motor running at 12,000 or 13,500 RPM.



Wick Lube System

Each tool includes Gear Oil and Oil Gun. Apply after every 8 hours of use.

95848 Gear Oil **95541** Oil Gun

TECH TIP 360° rotational exhaust can be adjusted to direct exhaust away from the operator.

COATED FLAP DISCS DYNACUT™ FLAP DISCS



Dia.	Grit	Shape	Wheel Attachment	Backing	Item #	Item #	Item #	Qty
4" (102 MM)	40	T29	5/8" (16 mm) Center Hole	Fiberglass	79439			10
	60				79440			10
4-1/2" (114 MM)	36	T27	7/8" (22 mm) Center Hole	Fiberglass			77756	10
	40						77757	10
	60						77758	10
	80						77759	10
	120						77760	10
	36							77761
	40				77762	10		
	60			Trimmable	77763		10	
	80				77764		10	
	120				77765		10	
5" (127 MM)	40	T29	7/8" (22 mm) Center Hole	Fiberglass			78386	10
	60				77793		78387	10
	80				77794		78388	10
	120						78389	10
5" (127 MM)	36	T27	7/8" (22 mm)	Fiberglass	77771	77766		10
	40				77772	77767		10
	60				77773	77768		10
	80				77774	77769		10
	120				77775	77770		10

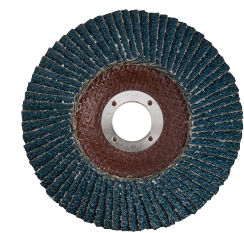

OPTIONAL BACKUP FLANGE

- For mounting high-profile abrasive Flap Disc with 7/8" center hole.
- 53697- for 5/8"-11 Models.
- 53630- for M14x2 Models.

TECH TIP Type-27 layered flap discs must be used with guarded tool.

FIBER DISCS

COATED ABRASIVES

COATED FIBER DISCS

Dynabrade's coated abrasive resin fiber discs are excellent choices for grinding, blending, general surface preparation and finishing of a broad range of materials. The three tiered line from general purpose aluminum oxide to premium ceramic alumina provide total performance solutions for small jobs to high production operations.

DISCS	49-52
↳ Fiber Discs	49-52



FIBER DISCS COATED ABRASIVE DISCS

The most heavy-duty of coated abrasive discs, Fiber Discs are designed for a variety of applications ranging from heavy stock removal to surface blending and finishing. They are used with rubber or high-strength plastic back-up pads on pneumatic or electric portable angle grinders. Common applications include stock removal, edge chamfering, weld blending, deburring, rust removal, cleaning and finishing of stainless steel and high nickel alloys, mild carbon steel, ferrous and non ferrous metals.

Fiber discs are available in 4-1/2", 5", 7" and 9" diameters in the most common grit sizes ranging from 36 grit to 80 grit.

1 DYNACUT™ CER FIBER DISCS

The PREFERRED choice for stainless steel, titanium and nickel based alloys, mild carbon steel and ferrous metals.

FEATURES

- 1 **Micro finishing, high-performance ceramic alumina grain**
- 2 **Self-lubricating, super-size grinding aid**
- 3 **100% Ceramic grain coating**

BENEFITS

- Continuously exposes sharp cutting edges extending product life.*
- Reduces heat buildup while minimizing glazing and loading on stainless steel, titanium and other high nickel based alloys.*
- Provides higher cut rates versus blended aluminum oxide/ceramic alumina abrasive discs.*



2 DYNACUT™ A/O ALUMINUM OXIDE

The GOOD starting point for general material removal, weld grinding, beveling, deburring and finishing.

FEATURES

- 1 **Tough high-performance aluminum oxide abrasive, phenolic resin bond and a durable 30 mil fiber backing**

BENEFITS

- Provides reliable, consistent performance on a wide range of materials.*



3 DYNACUT™ SILICON CARBIDE

The FIRST choice for aggressive grinding on nonferrous materials.

FEATURES

- 1 **An extra coarse Silicon Carbide grain, phenolic resin bonded to a durable fiber backing**

BENEFITS

- For exceptional material removal rates on epoxy, glues, fiberglass and composites, synthetic and natural stone, porcelain, china clay.*



APPLICATION GRIT GUIDE

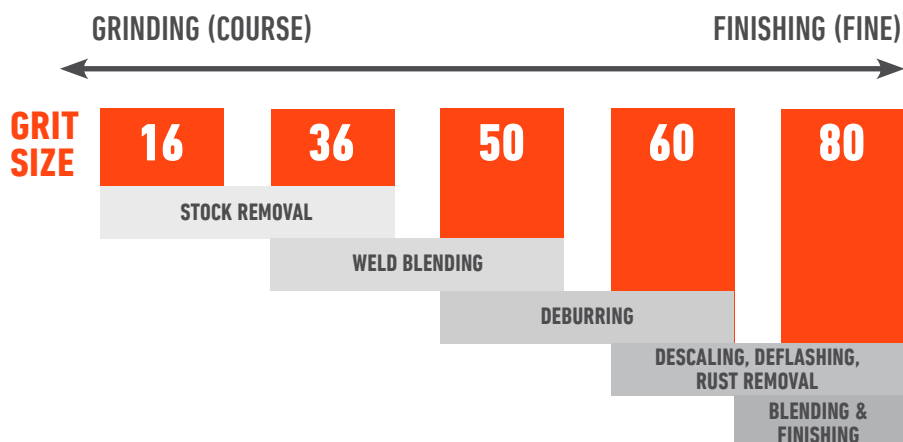

COMPETITOR CROSS REFERENCE

	PERFORMANCE		PRICE
	DYNACUT™ CER	DYNACUT™ A/O	
 3M	985C, 982C, 988C, 983C, 785C	381C, 281C, GreenCorp	
NORTON	F980, F981, F983	F726, Metal	
KLINGSPOR	FS 966	CS 561	
HERMES	CR456	RB 314	
GEMTEX	PMD Supreme, PMD Supreme Plus	A Type, C Type	
CAMEL	Premium Ceramic 2, Ceramic	Aluminum Oxide	
FLEXOVIT	Flexon CG	High Performance	
METABO	CER	NK	
PFERD	CO Cool, CO	A-Cool, A	
SAIT	SC-D-95, SC-D-8S	SC-D-3A	
VSM	XF870, XF760, XF885	KF708	
WALTER	CoolCut XX	Cool Cut	
WEILER	Saber Tooth	Aluminum Oxide	

COATED FIBER DISCS



Dia.	Grit	Center Hole	Item #	Item #	Item #	Qty
4-1/2" (114 MM)	16	7/8"			77779	25
	36		79325	79311		25
	50		79326	79312		25
	60		79327	79313		25
	80		79328	79314		25
5" (127 MM)	36	7/8"	79333	79315		25
	50		79334	79316		25
	60		79335	79317		25
	80		79336	79318		25
7" (178 MM)	36	7/8"	79337	79319		25
	50		79338	79330		25
	60		79339	79331		25
	80		79340	79332		25
9" (228 MM)	36	7/8"	78771			25
	50		78772			25
	60		78773			25
	80		78774			25



PAPER & FILM SHEETS

COATED ABRASIVES



COATED FILM & PAPER SHEETS

Dynabrade's Dynacut™ coated abrasive film and paper sheets are engineered to fit the complete range of Dynabrade pneumatic orbital and in-line finishing sanders. Available in vacuum and non vacuum hole configurations with PSA (pressure sensitive adhesive) or Hook & Loop attachment systems, this line of sheets provides a sanding and finishing solution for almost any application.

SHEETS	53-65
↳ Film, Paper & Detail Sheets	53-65

COATED ABRASIVE SHEETS PAPER & FILM

For use on the Dynabug®, Dynafine® and Dynaline Series of orbital and in-line finishing sanders, as well as all other sheet finish sanders. Dynabrade offers a wide selection of premium film and paper-backed, cut-to-size sheets. PSA, hook and loop and clip attachment styles are available for straight line, orbital and detail sanding tools with and without vacuum holes in most sizes.

DynaCut™ abrasive sheets are ideal for a wide variety of finish sanding applications on primers and coatings, plastics, composites, fiberglass and wood, finishing body filler compounds and gel coats. They are also used in metalworking for preparing bare, primed and painted surfaces, decorative and fine finishing.

DynaCut™ sheets range in size and shape from strips and die-cut shapes to standard 1/4", 1/3" and 1/2" cut sheet sizes. The variety of shapes and sizes sand everything from tight areas like grill work, to unique applications like sanding raised panels on cabinet doors or back splashes on counter tops.

DYNACUT™ BLUE ALUMINUM OXIDE CLOG FREE FILM

The BEST choice for dry finishing on all materials.

FEATURES

- 1 High-performance P-graded aluminum oxide abrasive
- 2 Flexible, high performance, 3 mil film backing
- 3 Clog-free coating

BENEFITS

- For fast cut and consistent finishes.
- For extra smooth finishes and consistently longer life than paper backed sheets.
- Provides resistance to loading extending productive life.



1

DYNACUT™ GOLD ALUMINUM OXIDE CLOG FREE PAPER

The BETTER choice for sanding a variety of surfaces like wood, primer, paint, plastics, fiberglass and composites.

FEATURES

- 1 P-graded aluminum oxide abrasive
- 2 Resin bond system
- 3 Tough, flexible paper backing
- 4 Special stearate top coating

BENEFITS

- For fast cut and long life.
- Provides improved grain adhesion and extends life.
- Durable and resistant to tearing.
- Provides resistance to clogging of dust and debris.



2

DYNACUT™ WHITE SILICON CARBIDE

The GOOD choice for sanding materials like wood, plastic, composites, glass and for sanding sealers, primers and paints.

FEATURES

- 1 Open coated with extremely sharp silicon carbide abrasive on a smooth B-weight paper backing
- 2 Resin bond system

BENEFITS

- Excellent for fine finishing.
- Provides improved grain adhesion and extends life.



3

COATED ABRASIVE SHEETS HOOK-FACE DYNACUT™ SHEETS

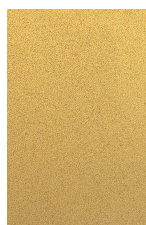

W x L	Grit	Vacuum Type	# of Holes	Item #	Item #	Item #	Qty
3" (75 MM) X 4-5/16" (110 MM)	60	Vacuum	4		93790		50
	80				93800		50
	100				93802		50
	120				93779		50
	150				93890		50
	180				93891		50
	220				93892		50
	320				93893		50
	400	Non-Vacuum	-		93781		50
	60				93783		50
	80				93782		50
	100				93784		50
	120				93785		50
	150				93786		50
	180				93787		50
	220				93788		50
320		93789		50			
400				93789		50	

DYNABUG II SANDERS



58502



58500

DYNABUG® II PADS

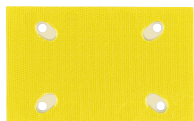
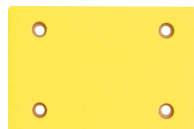

Pad Dimensions	Face	Vacuum Type	Item #
3" x 4-1/4" (74 mm x 109 mm)	Hook	Non-Vacuum	56315
		4 Vacuum Holes	56316



- Seen here is a bridging application using a Dynabug® II orbital sander. The fine 3/32" orbital motion of the sander is critical to evenly finishing a surface with a cavity or cutout. The Dynabug® II "bridges" the gap created by routing or machining and allows for each side of a cavity to be finished uniformly and without gouging.

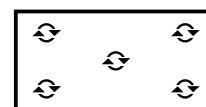

ORBITAL MOTION

COATED ABRASIVE SHEETS HOOK-FACE DYNACUT™ SHEETS

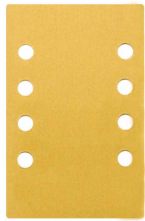
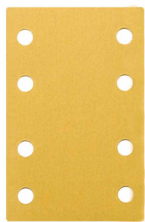

W x L	Grit	Vacuum Type	# of Holes	Item #	Item #	Item #	Qty		
3-1/4" (81 MM) X 5" (133 MM)	60	Vacuum	4 + 4		93866		50		
	80				93867		50		
	100				93868		50		
	120				93869		50		
	150				93934		50		
	180				93935		50		
	220				93936		50		
	320				93937		50		
	400				93874		50		
	60			Vacuum	8		93849		50
	80						93858		50
	100						93859		50
120		93864				50			
150		93895				50			
180		93896				50			
220		93897				50			
320		93898				50			
400		93865		50					
3-1/4" (81 MM) X 5" (133 MM)	60	Non-Vacuum	-		93844		50		
	80				93845		50		
	100				93846		50		
	120				93847		50		
	150				93791		50		
	180				93792		50		
	220				93793		50		
	320				93794		50		
400		93848		50					

DYNABUG® II SANDERS



COATED ABRASIVE SHEETS HOOK-FACE DYNACUT™ SHEETS



W x L	Grit	Vacuum Type	# of Holes	Item #	Item #	Item #	Qty		
3-2/3" (93 MM) X 7" (178 MM)	80	Vacuum	8		94011		50		
	100			94012	50				
	120			94013	50				
	150			94014	50				
	180			94015	50				
	220			94016	50				
	320			94017	50				
	400			94018	50				
	60			Non-Vacuum	-		93006		50
	80					93007	50		
	100					93801	50		
	120					93008	50		
	150					93803	50		
	180					93804	50		
220	93009	50							
320	93014	50							
400	93015	50							
"DELTA STYLE" 4" (100 MM) X 5-3/4" (148 MM)	60	Vacuum	7				93877		50
	80					93878	50		
	100					93796	50		
	120					93797	50		
	150					93798	50		
	180			93799	50				
	220			93879	50				
	320			93875	50				
400	93876	50							
4-1/2" (114 MM) X 4-1/4" (108 MM)	80	Non-Vacuum	-		93850		50		
	120			93851	50				
	180			93852	50				
	320			93853	50				

DYNABUG® SANDERS



Vacuum model shown

DYNABUG® II



58506

DYNABUG "MODEL T"



57923

COMPATIBLE PADS



DYNABUG "MODEL T"

Pad Dimensions	Thickness	Density	Item #
4-1/4" W X 4-1/2" L (108 mm x 114 mm)	Soft	5/8"	57996
	Medium	3/8"	57998

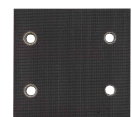

DYNABUG® II

Pad Dimensions	Face	Vac. Holes	Item #
3-7/8" x 5-5/8" (99 mm x 143 mm)	Hook	7 "Delta-Style"	56323

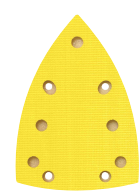

COATED ABRASIVE SHEETS PSA DYNACUT™ SHEETS



W x L	Grit	Vacuum Type	# of Holes	Item #	Item #	Item #	Qty	
3-1/4" (81 MM) X 5" (133 MM)	60	Vacuum	6		93819		50	
	80			93828	50			
	100			93829	50			
	120			93834	50			
	150			93775	50			
	180			93776	50			
	220			93777	50			
	320			93778	50			
	400			93839	50			
	60			Non-Vacuum	-		93806	50
	80					93807	50	
	100					93808	50	
	120					93809	50	
	150					93770	50	
180	93771	50						
220	93772	50						
400	93818	50						
3-2/3" (93 MM) X 7" (178 MM)	60	Non-Vacuum	-		93005	50		
	80			93810	50			
	120			93812	50			
	150			93813	50			
	180			93814	50			
	220			93815	50			
	320			93816	50			
	400			93817	50			

DYNABUG II SANDERS



COMPETITIVE CROSS REFERENCE

	DYNACUT™ BLUE A/O FILM	DYNACUT™ GOLD A/O PAPER	DYNACUT™ WHITE S/C PAPER
3M	735U, 375U, 255L	236U, 316U, Red, NX	414N, 415N, 415U, 426U
NORTON	Q275	A290, A296	A413
HERMES	VC153-LL	HCAB, HC135-LL, VC151-LL	PSF-LL, SA 168
KLINGSPOR	-	PS33, PL36	PL35
MIRKA	PolarStar, MicroStar	Bulldog Gold, Base Cut	Carat Flex
SIA	1950, 1940	1947	1748
VSM	-	CP918A, CP918C	CP 131A

COATED ABRASIVE SHEETS PSA DYNACUT™ SHEETS



W x L	Grit	Vacuum Type	# of Holes	Item #	Item #	Item #	Qty
2-3/4" (70 MM) X 8" (203 MM)	80	Vacuum	6		93710		50
	120				93712		50
	150				93713		50
	180				93714		50
	220				93715		50
	320				93716		50
	80	Non-Vacuum	-		93700		50
	120				93702		50
	150				93703		50
	180				93704		50
220				93705		50	
320				93706		50	
3" (75 MM) X 4-5/16" (110 MM)	80	Vacuum	4		93756		50
	100				93757		50
	120				93758		50
	150				93765		50
	180				93766		50
	220				93767		50
	320		93768		50		
	400		93759		50		
	60	Non-Vacuum	-		93751		50
	80				93752		50
	100				93753		50
	120				93754		50
	150				93760		50
	180				93761		50
220				93762		50	
320				93763		50	
400		93709		50			

DYNALINE SANDERS



DYNABUG II SANDERS



COMPATIBLE PADS

DYNALINE

Pad Dimensions	Face	Nap	Screws	Item #
2-3/4" x 8" (70 mm x 203 mm)	Vinyl	-	2	57454
			2	57460
			6	57455



DYNABUG® II

Pad Dimensions	Face	Vacuum Type	Item #
3" x 4-1/4" (108 mm x 114 mm)	Vinyl	Non-Vacuum	56355
		Vacuum 4 Holes	56356



COATED ABRASIVE SHEETS NON-VACUUM DYNACUT™ FULL SHEETS



W x L	Grit	Shape	Item #	Item #	Item #	Qty
9" (229 MM) X 11" (279 MM)	80	Full Sheets		93016		50
	100			93017		50
	120			93018		50
	150			93019		50
	180			93020		50
	220			93021		50
	320			93022		50
400		93023		50		



DYNABRADE INDUSTRY SEGMENT & PRODUCT CATALOGS

SEE THE COMPLETE LINE AT DYNABRADE.COM

- Dynorbital® Extreme Random Orbital Sander Series
- Welding Industry Dynabrade Product Line
- Rebel 2.8 hp Series 7" & 9" Grinders and Sanders

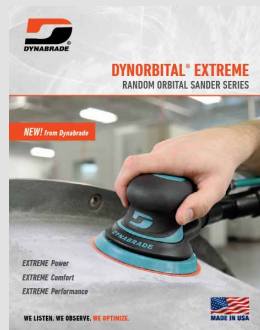

D17.03

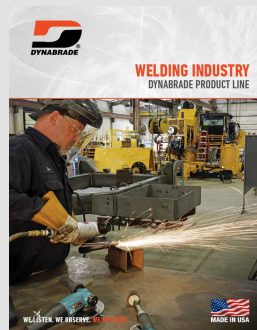

D16.07

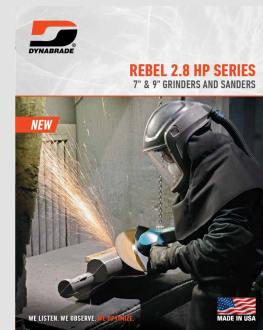

D17.09

COATED ABRASIVE SHEETS HOOK-FACE DYNACUT™ DETAIL SHEETS



Delta-Style	Grit	Vacuum Type	# of Holes	Item #	Item #	Item #	Qty
TEAR-DROP	80	Vacuum	6		93678		50
	120			93679	50		
	150			93680	50		
	180			93681	50		
	220			93698	50		
	320			93699	50		
	400	93701	50				
	80	Non-Vacuum	-		93953		50
	120			93954	50		
	150			93955	50		
	180			93956	50		
	220			93957	50		
320	93958			50			
400	93959	50					
TRIANGULAR	80	Vacuum	6		93652		50
	120			93653	50		
	150			93654	50		
	180			93655	50		
	220			93656	50		
	320			93657	50		
	80	Non-Vacuum	-		93913		50
	120			93914	50		
	150			93915	50		
	180			93916	50		
	220			93927	50		
	320			93928	50		
	400	93929	50				
	600	93938	50				

DYNAFINE® DETAIL SANDERS



COMPATIBLE PADS DYNAFINE®

TEAR DROP SHAPE

Pad Dimensions	Vacuum Type	Thickness	Holes	Attachment	Nap	Density	Screws	Item #
2-3/4" x 2-3/8" (95 mm x 60 mm)	Non-Vacuum	3/8" (10 mm)	0	Hook-Face	Short	Medium	2	57953
					Long		3	57954
	Vacuum	3/8" (10 mm)	6	Hook-Face	Short	Medium	2	58048



Non-Vacuum



Vacuum

COATED ABRASIVE SHEETS PSA DYNACUT™ DETAIL SHEETS

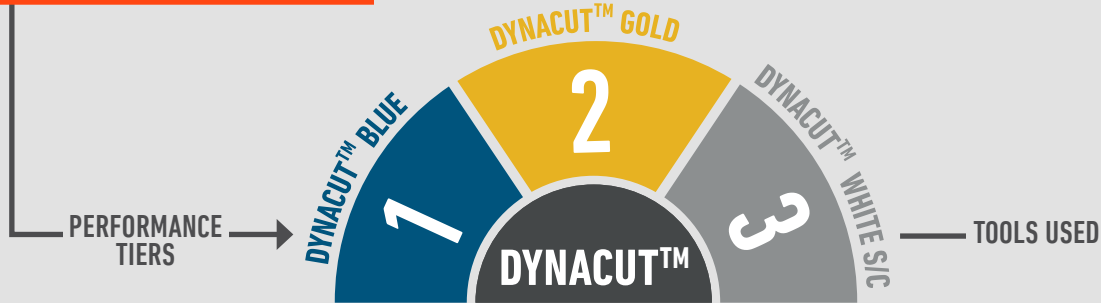

Delta-Style	Grit	Vacuum Type	# of Holes	Item #	Item #	Item #	Qty
TEAR-DROP	80	Vacuum	6		93690		50
	120				93691		50
	150				93962		50
	180				93963		50
	220				93694		50
	320				93695		50
	400				93697		50
	80	Non-Vacuum	-		93993		50
	120				93994		50
	150				93995		50
	180				93996		50
	220				93998		50
	320				93999		50
	400				94000		50
TRIANGULAR	80	Vacuum	6		93639		50
	120				93640		50
	150				93641		50
	180				93642		50
	220				93643		50
	320				93644		50
	400				93645		50
	80	Non-Vacuum	-		93983		50
	120				93984		50
	150				93985		50
	180				93986		50
	220				93987		50
	320				93988		50
	400				93989		50

DYNAFINE® DETAIL SANDERS



COMPATIBLE PADS DYNAFINE®

TRIANGULAR SHAPE

Pad Dimensions	Vacuum Type	Thickness	Holes	Attachment	Nap	Density	Screws	Item #
2-7/8" x 3-1/8" (73 mm x 79 mm)	Non-Vacuum	3/8" (10 mm)	0	Hook-Face	Short	Medium	2	57951
					Long		3	57955
	Vacuum	3/8" (10 mm)	6	Hook-Face	Short	Medium	2	58049



Non-Vacuum



Vacuum

COATED ABRASIVE STRIPS HOOK-FACE RAISED PANEL STRIPS



W x L	Grit	Item #	Item #	Item #	Qty
4-1/2" (114 MM) X 7/8" (22 MM)	80	93663			50
	120	93664			50
	150	93670			50
	180	93671			50
	220	93672			50
4-1/2" (114 MM) X 1-3/8" (35 MM)	320	93673			50
	400	96377			50
	80	94001			10
	120	94002			10
	150	94003			10
1-3/8" (35 MM)	180	94004			10
	220	94005			10
	320	94006			10
	400	94007			10



COMPATIBLE PADS DYNAFINE®

RAISED PANEL SHAPE



Length x Width	Vacuum Type	Thickness	Attachment	Nap	Density	Screws	Item #
4" x 3/4" (102 mm x 19 mm)	Non-Vacuum	3/8" (10 mm)	Hook-Face	Short	Soft	2	57956

NOTE: 98293 Complete Raised Panel Pad Assembly includes 57956 pad, mounting plate and two screws. 57905 Kit includes 57956 pad and eight abrasive strips. 98292 Adapter mounts to tool (no pad included).

RAISED PANEL SANDER

- Unique angled edges for sanding in tight corners and on raised panel edges.
- Ideal for use on furniture, shutters, moldings and more.

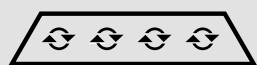

1/32" Orbit



COATED ABRASIVE STRIPS PSA DYNACUT™ STRIPS



W x L	Grit	Vacuum Type	Item #	Item #	Item #	Item #	Item #	Qty
3/4" (19 MM) X 2" (51 MM)	120	N/A	•	•	93943	•	•	20
	180		•	•	93944	•	•	20
	240		•	•	93945	•	•	20
3/8" (10 MM) X 2" (51 MM)	120	N/A	•	•	93940	•	•	20
	180		•	•	93941	•	•	20
	240		•	•	93942	•	•	20
3-1/2" (89 MM) X 2-3/4" (70 MM)	80	Non-Vacuum	•	•	•	•	93130	50
	120		•	•	•	•	93131	50
	150		•	•	•	•	93132	50
1/2" (13 MM) X 6" (152 MM)	80	N/A	•	90955	•	•	•	10
	120		•	•	•	•	•	10
	180		•	90957	•	•	•	10
	240		•	•	•	•	•	10



• Call for availability and pricing.



COMPATIBLE PADS DYNAFINE® BACKSPLASH SANDING PADS

RADIUS NON-VACUUM PADS

Radius Dimension	Shape	Face	Item #
1/4" (6 mm)		Vinyl	58020
3/8" (10 mm)			58021
1/2" (13 mm)			58022
5/8" (16 mm)			58023

REVERSE RADIUS NON-VACUUM PAD

Radius Dimension	Shape	Face	Item #
3/4" (19 mm)		Vinyl	58024



COATED ABRASIVE ROLLS DYNACUT™ PSA ROLLS

- Aluminum oxide rolls are ideal for light deburring and scouring. Also used for rust and scale removal, blending machine tool marks, plus fine sanding and polishing.

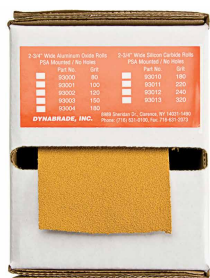

Roll Width	Grit	Yards Per Roll	Item #	Item #	Item #	Item #	Item #	Qty
2-3/4" (70 MM)	80	25	•	•	79300	•	•	1
	100	30	•	•	79301	•	•	1
	120		•	•	79302	•	•	1
	150		•	•	79303	•	•	1
	180	45	•	•	79304	•	•	1
3-2/3" (93 MM)	80	25	•	•	79306	•	•	1
	100	30	•	•	79307	•	•	1
	120		•	•	79308	•	•	1
	150		45	•	•	79309	•	•
	180	50	•	•	79310	•	•	1

• Call for availability and pricing.



DYNALINE SANDER IN-LINE FINISHING SANDER



- Seen here is the final step of an in-line graining application using a Dynaline sander and non-woven abrasive. A typical graining application begins with a coated abrasive grit sequence that creates a uniform surface free of defects then finishes with a non-woven abrasive to blend, smooth scratches created by the coated abrasive.

SPECIALTIES COATED ABRASIVES



COATED FILM & PAPER SHEETS

Specialty coated abrasives are unique abrasive shapes used on a variety of portable tools like die grinders, pencil grinders and other straight shaft sanders that enable the end user to grind, deburr, blend, finish and sand difficult shapes or reach areas that conventional abrasives shapes and tools cannot. The Dynabrade Dynacut™ line of specialties includes cartridge rolls, overlap slotted discs, sanding stars and eyelet stars, spiral bands, square pads and cross pads in grit ranges for a broad range of applications and materials.

SPECIALTIES	66-84
↳ Sanding Stars	68-70
↳ Cross Pads	71-72
↳ Square Pads	73
↳ Overlap Slotted Discs	74
↳ Cartridge Rolls	75-79
↳ Spiral Bands	80-81
↳ Flap Wheels & Brushes	82-84

COATED ABRASIVE SPECIALTIES

DynaCut™ coated abrasive specialties combined with the wide range of Dynabrade tools provide a broad range of solutions for deburring, sanding, blending and finishing. A wide variety of shapes, sizes, grits and grains allow Dynabrade abrasives to provide solutions in many markets like woodworking, metal fabrication, welding, marine, transportation, aerospace, wind energy and more!

Dynabrade DynaCut™ Coated Abrasive Specialties include sanding stars, eyelet stars, DynaPoint® cartridge rolls, flap wheels and mini-flap wheels as well as traditional cartridge rolls, cross pads, square pads, overlapped slotted discs and spiral bands.

DYNACUT™ ALUMINUM OXIDE

The GOOD choice for deburring, sanding, scuffing and finishing of a wide variety of materials and surface shapes.

FEATURES

1 Premium aluminum oxide

BENEFITS

For fast cut and consistent finishes.

2 Synthetic resin adhesive

Provides a strong bond to the backing ensuring uniform and consistent wear of the backing, grain and bond.

3 X-weight Cotton Backing

Flexible yet durable, providing uniform grain and bond wear; resulting in a constant cutting action with consistent finish throughout the life of the product.



1

DYNACUT™ ZIRCONIA ALUMINA

The BETTER choice for grinding, deburring, heavy stock removal, blending, dimensioning and shaping and finishing.

FEATURES

1 Zirconia alumina abrasive

BENEFITS

Sharp and tough for fast material removal and long life.

2 Resin bond system

Provides strong grain adhesion reducing grain shedding.

3 X-weight cotton backing

Flexible yet durable, providing uniform grain and bond wear; resulting in a constant cutting action with consistent finish throughout the life of the product.



2

SANDING STARS

DynaCut™ aluminum oxide sanding stars are uniquely designed for consistent performance and versatility. Sanding stars are utilized in wood and metal working applications to sand, deburr and polish. Typically used on contoured, curved, or uneven surfaces sanding stars help prevent undercutting through their flexibility and conformability. Woodworkers can eliminate tedious hand sanding on crown moulding, door panels or finish the inside of wooden bowls while metalworkers often use sanding stars in light deburring applications or for weld spatter removal or even scuffing a surface in preparation for a coating. Available in arbor, spindle and eyelet mount options from 4" to 8" in diameter and 80 - 400 grit.

ARBOR-MOUNT

TOOLS USED

Dia.	Grit	Max. RPM	Item #	Pkg. Qty
4" (102 MM) X 1/2"	80	3,200	93392	10
	120		93393	10
	150		93394	10
	180		93395	10
	220		93396	10
	320		93397	10
	400		93398	10
8" (203 MM) X 1/2"	80	950	93243	1
	120		93245	1
	150		93246	1
	180		93247	1
	220		93248	1
	320		93251	1
	400		93252	1



LIGHTWEIGHT DYNINGER



DYNINGER

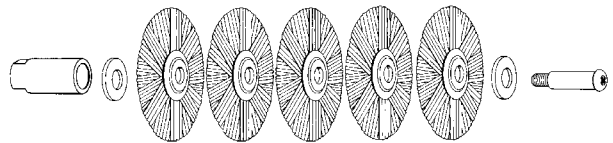
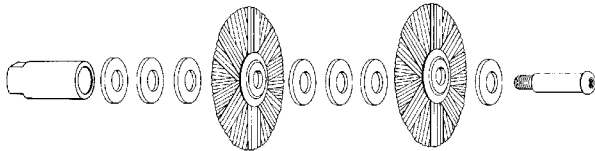
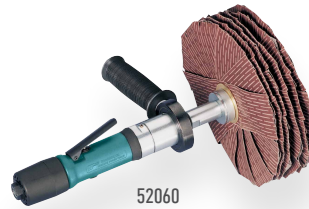

TECH TIP
The grit size and spacing of sanding stars determines the sanding aggressiveness. Try various grit and spacing configurations to get the best results.

SPINDLE-MOUNT

- 4" diameter, spindle-mount sanding stars are conveniently mounted using a 1/4" collet or drill chuck and come in a preassembled shape for use on a variety of Dynabrade finishing tools.

Dia.	Grit	Max. RPM	Item #	Pkg. Qty
4" (102 MM) X 1/4" SHAFT	80	3,200	93166	1
	120		93167	1
	150		93168	1
	180		93169	1
	220		93171	1
	320		93172	1
	400		93173	1



LIGHTWEIGHT DYNINGER



EYELET SANDING STARS DYNACUT™ A/O EYELET SANDING STARS

DynaCut™ aluminum oxide eyelet sanding stars are available in 1/2" to 5" in diameter. The center-threaded eyelet provides excellent balance at high RPM's and when matched with extension shaft mandrels or flexible shaft mandrels eyelet sanding stars provide a unique solution for deburring and polishing inside diameters of curved and straight pipe and tubing.

EYELET-MOUNT



	Grit	Female Thread	Max. RPM	Item #	Pkg. Qty		3" Length	7" Length
1/2" DIAMETER	60	3-48	25,000	93593	50	COMPATIBLE STAR MANDRELS	93534	93533
	80			93594	50			
	120			•	50			
	150			93595	50			
	180			•	50			
	220			93596	50			
	320			•	50			
	400			•	50			
3/4" DIAMETER	60	3-48	25,000	78569	50	COMPATIBLE STAR MANDRELS	93534	93533
	80			93579	50			
	120			93580	50			
	150			93581	50			
	180			93582	50			
	220			93583	50			
	320			•	50			
	400			•	50			
1" DIAMETER	60	3-48	25,000	78570	50	COMPATIBLE STAR MANDRELS	93534	93533
	80			93586	50			
	120			93587	50			
	150			93588	50			
	180			93589	50			
	220			93590	50			
	320			•	50			
	400			•	50			
1-1/2" DIAMETER	60	8-32	24,000	78571	50	COMPATIBLE STAR MANDRELS	93548	93532
	80			93541	50			
	120			93542	50			
	150			93543	50			
	180			93544	50			
	220			93545	50			
	320			93546	50			
	400			93547	50			

MANDRELS

3" LENGTH



93534, 93548, 93550

7" LENGTH



93531, 93532, 93533



93534



93533



93548



93532

EYELET SANDING STARS CONTINUED

EYELET MOUNT

TOOLS USED

	Grit	Female Thread	Max. RPM	Item #	Pkg. Qty		3" Length	7" Length						
2" DIAMETER	60	1/4-20	18,000	78572	50	COMPATIBLE STAR MANDRELS	93550	93531						
	80			93551	50									
	120			93552	50									
	150			93553	50									
	180			93554	50									
	220			93555	50									
	320			93556	50									
	400			93557	50									
3" DIAMETER	60	1/4-20	18,000	78573	50	COMPATIBLE STAR MANDRELS	93550	93531						
	80			93558	50									
	120			93559	50									
	150			93560	50									
	180			93561	50									
	220			93562	50									
	320			93563	50									
	400			93564	50									
4" DIAMETER	60	1/4-20	12,000	78574	50	COMPATIBLE STAR MANDRELS	93550	93531						
	80			93565	50									
	120			93566	50									
	150			93567	50									
	180			93568	50									
	220			93569	50									
	320			•	50									
	400			•	50									
	5" DIAMETER			60	1/4-20				10,000	78575	50	COMPATIBLE STAR MANDRELS	93550	93531
				80						78576	50			
120		78577	50											
150		•	50											
180		78578	50											
220		•	50											
320		•	50											
400		•	50											

.5 HP DIE GRINDER



1 HP DIE GRINDER

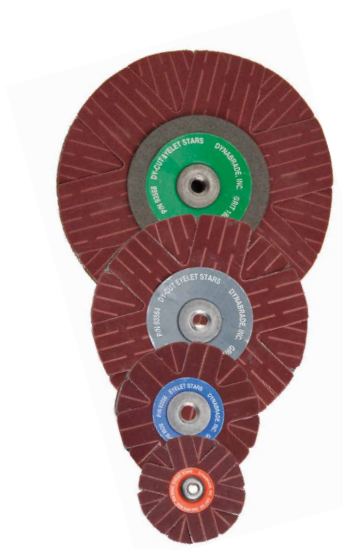

Note: The rate RPM of an eyelet sanding star is reduced when using flexible shafts. When using the flex shaft for finishing inside diameters, place the eyelet sanding star inside the workpiece and then start the tool.

CROSS PADS

DynaCut™ aluminum oxide cross pads, square pads and overlap slotted discs are used on die grinders to provide a wide range of deburring, blending, cleaning and finishing solutions. The variety of sizes, shapes and grit sizes can provide a tailor-made solution to almost any application and part form. The unique shapes provide aggressiveness with flexibility, and allow for visibility of the surface when in motion enabling the operator to control of stock removal and final finish. Available in sizes from 3/4" diameter to 4" diameter and grits from 60 to 180 grit with 60, 80 and 120 grit being the most commonly used grades.

A/O CROSS PADS

- DynaCut™ Aluminum Oxide Cross Pads are designed for finishing and polishing of the internal surfaces of tubing and cylinders. The design of DynaCut cross pads, when in motion, allows the operator to see the work surface and control stock removal and the resulting finish. All DynaCut cross pads come with threaded eyelets for quick changeover on regular and flexible shaft mandrels.

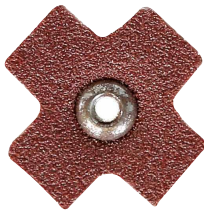

	Grit	Ply	Eyelet	Max. RPM	Item #	Pkg. Qty	3" Length	7" Length
3/4" X 3/8"	60	8	3-48	24,000	93597	100	93534	93533
	80				93598	100		
	120				78457	100		
	150				93607	100		
	180				78458	100		
	240				93608	100		
1" X 3/8"	60	8	3-48	24,000	93609	100	93534	93533
	80				93617	100		
	120				78459	100		
	150				93618	100		
	180				78460	100		
	240				93619	100		
1-1/2" X 1/2"	60	8	8-32	24,000	93651	100	93548	93532
	80				93660	100		
	120				78461	100		
	150				93669	100		
	180				78462	100		
	240				93708	100		

COMPATIBLE STAR MANDRELS

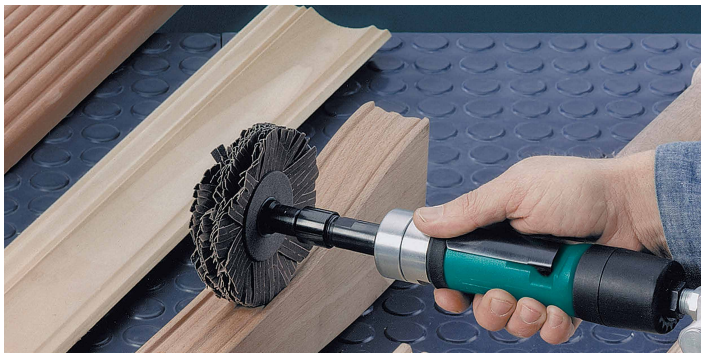
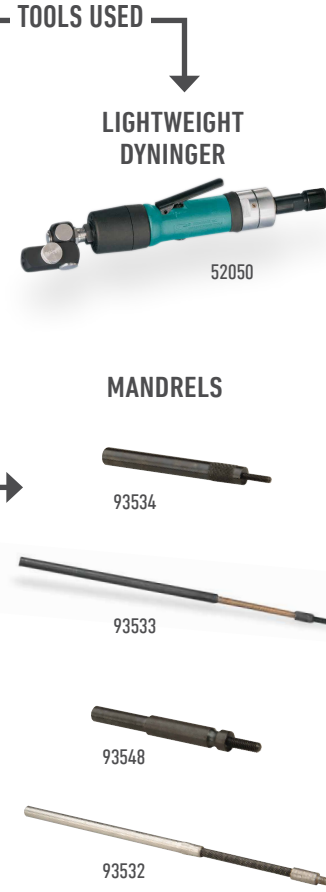

CROSS PADS DYNACUT™ A/O CONTINUED

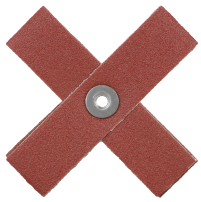

	Grit	Ply	Eyelet	Max. RPM	Item #	Pkg. Qty
2" X 1/2"	60	8	8-32	18,000	93904	100
	80				93905	100
	120				78463	100
	180				78464	100
2" X 3/4"	60	8	8-32	18,000	78465	100
	80				78466	100
	120				78467	100
	180				78468	100
2" X 1"	60	8	1/4-20	20,000	78469	100
	80				78470	100
	120				78471	100
	180				78472	100
2-1/2" X 3/4"	60	8	8-32	20,000	78473	100
	80				78474	100
	120				78475	100
	180				78476	100
3" X 1"	60	8	1/4-20	18,000	78477	100
	80				78478	100
	120				78479	100
	180				78480	100
	60				10	1/4-20
	80	78482	100			
	120	78483	100			
	180	78484	100			

	Grit	Ply	Eyelet	Max. RPM	Item #	Pkg. Qty
3" X 1-1/2"	60	10	1/4-20	15,000	78485	100
	80				78486	100
	120				78487	100
	180				78488	100
4" X 1"	60	8	1/4-20	12,000	78489	100
	80				78490	100
	120				78491	100
	180				78492	100
4" X 2"	60	8	1/4-20	12,000	78493	100
	80				78494	100
	120				78495	100
	180				78496	100

COMPATIBLE MANDRELS

7" LENGTH



3" LENGTH



TOOLS USED

**.4 HP STRAIGHT-LINE
DIE GRINDER**



**.5 HP STRAIGHT-LINE
DIE GRINDER**



**1 HP STRAIGHT-LINE
DIE GRINDER**



- Each tool can run abrasives found on this page.

SQUARE PADS



A/O SQUARE PADS

- DynaCut™ aluminum oxide square pads are ideal for blending welds on the inside of piping, channels, fillets and corners as well as removing welds on flat surfaces. The corners of square pads wear down consistently exposing fresh abrasive continually as the pad wears. The intermittent impact from the pad corners provides an aggressive and fast cutting action that does not leave the swirl marks left by abrasive discs.

	Grit	Ply	Eyelet	Max. RPM	Item #	Pkg. Qty
1" X 1/4"	60				78497	100
	80	8	8-32	25,000	78498	100
	120				78500	100
1" X 1/2"	60				78501	100
	80	8	8-32	25,000	78502	100
	120				78504	100
1-1/2" X 1/2"	60				78505	100
	80	8	1/4-20	23,000	78506	100
	100				78507	100
	120				78508	100
1-1/2" X 3/4"	60				78509	100
	80	8	1/4-20	23,000	78510	100
	120				78512	100
2" X 1/2"	60				78513	100
	80	8	1/4-20	12,000	78514	100
	120				78516	100

	Grit	Ply	Eyelet	Max. RPM	Item #	Pkg. Qty
2" X 3/4"	60				78517	100
	80	8	1/4-20	12,000	78518	100
	120				78520	100
2-1/2" X 1/4"	60				78521	100
	80	8	1/4-20	12,000	78522	100
	120				78524	100
2-1/2" X 1/2"	60				78525	100
	80	8	1/4-20	12,000	78526	100
	120				78528	100
3" X 1/4"	60				78529	100
	80	8	1/4-20	9,000	78530	100
	120				78532	100
3" X 1/2"	60				78533	100
	80	8	1/4-20	9,000	78534	100
	120				78536	100

*See previous page (72) for compatible mandrels.

TOOLS USED

.4 HP STRAIGHT-LINE
DIE GRINDER



.5 HP STRAIGHT-LINE
DIE GRINDER



1 HP STRAIGHT-LINE
DIE GRINDER



- Each tool can run abrasives found on this page.

OVERLAP SLOTTED DISCS

A/O OVERLAP SLOTTED DISCS

- DynaCut™ aluminum oxide overlap slotted discs are an effective abrasive for deburring and polishing of cylinder walls, radii and holes; also used for light chamfering. Dynacut™ 2-set overlap slotted discs cut on the inward motion and are assembled with threaded eyelets for quick changeover.



	Grit	Eyelet	Max. RPM	Item #	Pkg. Qty
3/4" 2-SET	60	3-48	25,000	78537	100
	80			78538	100
	120			78539	100
	180			78540	100
1" 2-SET	60	8-32	25,000	78541	100
	80			78542	100
	120			78543	100
	180			78544	100
1-1/4" 2-SET	60	8-32	23,000	78545	100
	80			78546	100
	120			78547	100
	180			78548	100
1-1/2" 2-SET	60	8-32	23,000	78459	100
	80			78550	100
	120			78551	100
	180			78552	100

	Grit	Eyelet	Max. RPM	Item #	Pkg. Qty
2" 2-SET	60	8-32	23,000	78553	100
	80			78554	100
	120			78555	100
	180			78556	100
2-1/2" 2-SET	60	8-32	18,000	78557	100
	80			78558	100
	120			78559	100
	180			78560	100
3" 2-SET	60	1/4-20	14,000	78561	100
	80			78562	100
	120			78563	100
	180			78564	100
4" 2-SET	60	1/4-20	12,000	78565	100
	80			78566	100
	120			78567	100
	180			78568	100

APPLICATION GUIDE

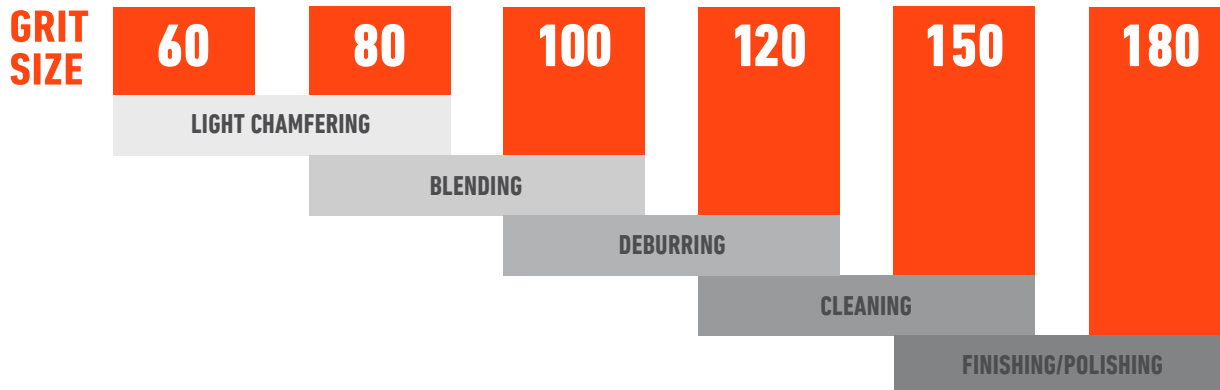

CARTRIDGE ROLLS

DynaCut™ aluminum oxide and DynaCut™ zirconia alumina cartridge rolls are made from strips of resin-bonded, cloth-backed coated abrasives that are rolled and glued into a solid layered form that breaks down consistently during use. Cartridge rolls are used on die grinders with a mandrel to blend, deburr and finish in small spaces, recesses and corners where larger tools cannot reach. The stock shapes for DynaCut™ cartridge rolls are standard and full tapered, and are available in multiple sizes from 1/4" to 1" diameter and from 1" to 2" in length for regular cartridge rolls. Also available are unique 7" long cartridge rolls for the Dynabrade DynaPoint. The stocked grit range for DynaCut™ cartridge rolls is 36 – 180.

A/O STRAIGHT CARTRIDGE ROLLS

	Grit	Max. RPM	Item #	Pkg. Qty
1/4" X 1" X 1/8"	60	24,000	78579	100
	80		78580	100
	120		78581	100
	180		78582	100
1/4" X 1-1/2" X 1/8"	60	24,000	78583	100
	80		78584	100
	120		78585	100
	180		78586	100
1/4" X 2" X 1/8"	60	24,000	78587	100
	80		78588	100
	120		78589	100
3/8" X 1" X 1/8"	60	24,000	78590	100
	80		78591	100
	120		78592	100
	180		78593	100

	Grit	Max. RPM	Item #	Pkg. Qty
3/8" X 1-1/2" X 1/8"	60	24,000	78594	100
	80		78595	100
	120		78596	100
	180		78597	100
3/8" X 2" X 1/8"	60	24,000	78598	100
	80		78599	100
	120		78600	100
	150		78601	100
1/2" X 1" X 1/8"	60	24,000	78602	100
	80		78603	100
	120		78604	100
	180		78605	100

	Grit	Max. RPM	Item #	Pkg. Qty
3/4" X 2" X 1/4"	60	16,000	78621	100
	80		78622	100
	120		78623	100
1" X 1-1/2" X 1/4"	60	15,000	78624	100
	80		78625	100
	120		78626	100
	180		78627	100
1" X 2" X 1/4"	60	15,000	78628	100
	80		78629	100
	120		78630	100
	180		78631	100

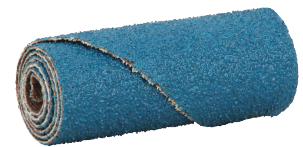

APPLICATION GUIDE

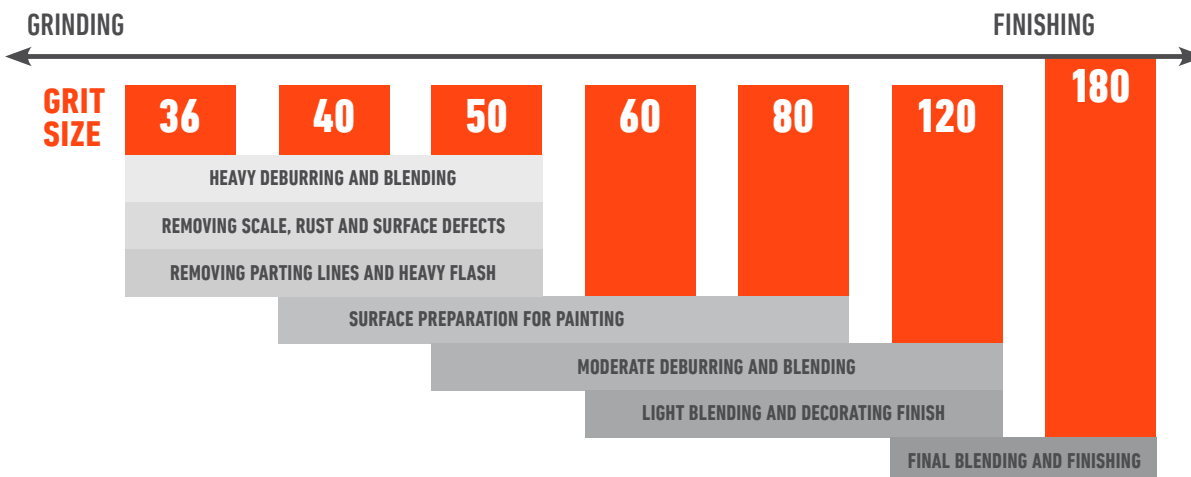

CARTRIDGE ROLLS CONTINUED

Z/A STRAIGHT CARTRIDGE ROLLS



	Grit	Max. RPM	Item #	Pkg. Qty
3/8" X 1" X 1/8"	36	24,000	78632	100
	60		78633	100
	80		78634	100
	120		78635	100
3/8" X 1-1/2" X 1/8"	36	24,000	78636	100
	60		78637	100
	80		78638	100
	120		78639	100
1/2" X 1" X 1/8"	36	24,000	78640	100
	60		78641	100
	80		78642	100
	120		78643	100
1/2" X 1-1/2" X 1/8"	36	24,000	78644	100
	60		78645	100
	80		78646	100
	120		78647	100
5/8" X 1-1/2" X 3/16"	36	16,000	78648	100
	60		78649	100
	80		78650	100
	120		78651	100

TOOLS USED

.4 HP STRAIGHT-LINE DIE GRINDER



.5 HP STRAIGHT-LINE DIE GRINDER



1 HP STRAIGHT-LINE DIE GRINDER



CARTRIDGE ROLLS CONTINUED

A/O FULL TAPERED CARTRIDGE ROLLS

	Grit	Max. RPM	Item #	Pkg. Qty
3/8" X 1" X 1/8"	60	24,000	78652	100
	80		78653	100
	120		78654	100
	180		78655	100
3/8" X 1-1/2" X 1/8"	60	24,000	78656	100
	80		78657	100
	120		78658	100
	180		78659	100
1/2" X 1" X 1/8"	60	24,000	78660	100
	80		78661	100
	120		78662	100
1/2" X 1-1/2" X 1/8"	60	24,000	78663	100
	80		78664	100
	120		78665	100
	180		78666	100

TOOLS USED



	Grit	Max. RPM	Item #	Pkg. Qty
1/2" X 2" X 1/8"	60	24,000	78667	100
	80		78668	100
	120		78669	100
5/8" X 1-1/2" X 1/8"	60	16,000	78670	100
	80		78671	100
	120		78672	100
3/4" X 1-1/2" X 1/8"	60	16,000	78673	100
	80		78674	100
	120		78675	100



CARTRIDGE ROLLS

A/O DYNAPPOINT® CARTRIDGE ROLLS



W x L	Grit	Max. RPM	Item #	Pkg. Qty
1/2" (13 MM) W X 7" (178 MM) L	50	15,500	90616	5
	60		90623	5
	80		90624	5
	120		90625	5
3/4" (19 MM) W X 7" (178 MM) L	50	15,500	90680	5
	60		90681	5
	80		90682	5
	120		90683	5
	Assorted 50, 60, 120		90685	3

TOOL USED

DYNAPPOINT® II

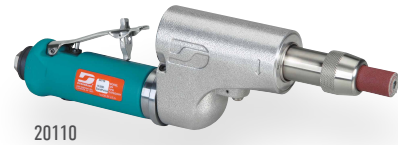

20110

DYNAPPOINT® II ABRASIVE FINISHING TOOL



- Only tool on the market to run 7" (178 mm) long abrasive cartridge rolls for longer life, saving time and money.
- DynaRoll abrasives last up to 9X longer over industry standard cartridge rolls.
- 3/4" DynaRoll - maximum extension of 2-1/2" (63 mm)
- 1/2" DynaRoll - maximum extension of 1-3/4" (44 mm)

TECH TIP

To ensure proper abrasive orientation always insert Dynapoint cartridge roll with the grit marking inside the hand-tight collet.

CARTRIDGE ROLL MANDRELS

STANDARD LENGTH MANDRELS



Pilot Dia.	Pilot Length	Shank Dia.	Shank Length	Item #	Type
1/8"	3/4"	1/8"	1"	78686	D4
	1"	1/8"	1"	78687	D5
	1/2"	1/8"	1"	78688	D6
	3/4"	1/4"	1-1/4"	78689	D8
	1"	1/4"	1-1/4"	78690	D9
	1/2"	1/4"	1-1/4"	78691	D10
3/16"	1"	1/4"	1-1/4"	78692	D16
1/4"	1"	1/4"	1-1/4"	78693	D21
	1-1/2"	1/4"	1-1/4"	78694	D22

TOOLS USED



EXTRA LENGTH MANDRELS



Pilot Dia.	Pilot Length	Shank Dia.	Shank Length	Item #	Type
1/8"	3/4"	1/4"	4"	78695	D8-4
	3/4"	1/4"	6"	78696	D8-6
	1"	1/4"	3"	78697	D9-3
	1"	1/4"	4"	78698	D9-4
	1"	1/4"	6"	78699	D9-6
	1"	1/4"	8"	78700	D9-8
	1-1/2"	1/4"	1-3/4"	78701	D10-4
	1-1/2"	1/4"	3-3/4"	78702	D10-6

TOOLS USED



SPIRAL BANDS

DynaCut™ zirconia alumina spirals bands (no-lap bands) are one of the best product shapes for grinding, deburring, heavy stock removal, blending surface imperfections, shaping and finishing where a smooth running abrasive surface is needed. The spiral “no-lap” construction eliminates chatter marks enabling the operator to achieve tight tolerances finishing curved, concave, convex and other hard to reach surfaces. Used with expanding rubber wheels and spindle mounted slotted wheels, DynaCut™ spiral bands are easy to change from grit to grit.

Stocked in the most commonly used grits, of 36, 60, 80 and 120. Sizes from 1" to 3" wide and diameters from 1" to 5" cover the broadest range of applications and part sizes.

Z/A SPIRAL BANDS



	Grit	Item #	Pkg. Qty
1" (25 MM) DIA. X 1" (25 MM) W	36	92012	10
	60	92013	10
	80	91069	10
	120	91079	10
1" (25 MM) DIA. X 1-1/2" (38 MM) W	36	92014	10
	60	92018	10
	80	91070	10
	120	91073	10
1" (25 MM) DIA. X 2" (51 MM) W	36	92019	10
	60	92020	10
	80	91071	10
	120	91074	10
1-1/2" (38 MM) DIA. X 1-1/2" (38 MM) W	36	92030	10
	60	92034	10
	80	91079	10
	120	91082	10

	Grit	Item #	Pkg. Qty
1-1/2" (38 MM) DIA. X 2" (51 MM) W	36	92037	10
	60	92038	10
	80	91080	10
	120	91083	10
2" (51 MM) DIA. X 1" (25 MM) W	36	92039	10
	60	92044	10
	80	91087	10
	120	91090	10
2" (51 MM) DIA. X 2" (51 MM) W	36	92051	10
	60	92061	10
	80	91089	10
	120	91092	10
1-1/2" (38 MM) DIA. X 1-1/2" (38 MM) W	36	92030	10
	60	92034	10
	80	91079	10
	120	91082	10

SLOTTED WHEELS



Dimensions (Diameter x Width)	Band Size (Width x Length)	Maximum RPM	Item #
1" X 1"	1" x 1"		92910
1" X 1-1/2"	1" x 1-1/2"	10,000 - 12,000	92911
1" X 2"	1" x 2"		92912
1-1/2" X 1"	1-1/2" x 1"		92913
1-1/2" X 1-1/2"	1-1/2" x 1-1/2"	6,000 - 10,000	92914
1-1/2" X 2"	1-1/2" x 2"		92915
2" X 1"	2" x 1"		92916
2" X 1-1/2"	2" x 1-1/2"	4,500 - 7,500	92917
2" X 2"	2" x 2"		92918

TOOLS USED

.4 HP STRAIGHT-LINE DIE GRINDER



.5 HP DIE GRINDER



1 HP STRAIGHT-LINE DIE GRINDER



SPIRAL BANDS CONTINUED

Z/A SPIRAL BANDS



	Grit	Item #	Pkg. Qty
3" (76 MM) DIA. X 1" (25 MM) W	36	90700	10
	60	90712	10
	80	90724	10
	120	90736	10
3" (76 MM) DIA. X 2" (51 MM) W	36	90701	10
	60	90713	10
	80	90725	10
	120	90737	10
3" (76 MM) DIA. X 3" (76 MM) W	36	90709	10
	60	90719	10
	80	90731	10
	120	90743	10
4" (102 MM) DIA. X 1" (25 MM) W	36	90702	10

	Grit	Item #	Pkg. Qty
4" (102 MM) DIA. X 2" (51 MM) W	36	90703	10
5" (127 MM) DIA. X 1" (25 MM) W	36	90704	10
	60	90716	10
	80	90728	10
5" (127 MM) DIA. X 2" (51 MM) W	120	90740	10
	36	90705	10
	60	90717	10
5" (127 MM) DIA. X 3" (76 MM) W	80	90729	10
	120	90741	10
	36	90707	10
5" (127 MM) DIA. X 3" (76 MM) W	60	90706	10
	80	90708	10
	120	90710	10

DYNAFLEX EXPANDER WHEELS



Dimensions (Diameter x Width)	Arbor Hole	Replacement Hub	Replacement Flexer	Band Size (Dia. x Width)	Maximum RPM	Item #
3" X 1"	5/8"-11 Female	97525	94578	3" x 1"	8,000 with Band	94560
3" X 2"		97256	94579	3" x 2"		94561
3" X 3"		97258	97280	3" x 3"		94875
5" X 1"	5/8"-11 Female	94580	94580	5" x 1"	5,000 with Band	94564
5" X 2"		94581	94581	5" x 2"		94565



FLAP WHEELS

Flap wheels and interleaved flap wheels are an excellent choice for deburring, blending, cleaning and finishing applications in metal fabrication, welding and metal polishing markets. Made in various sizes in both spindle mount and arbor mount, flap wheels fit a wide range of Dynabrade die grinders, Dynastraight® flapper and Dynastraight® finishing tools. Flap wheels are engineered to generate a consistent cut rate and finish by wearing away evenly continuously exposing sharp abrasives. Flexible and conformable they are ideal for use on intricate shapes and contours.

SPINDLE MOUNTED FLAP WHEELS

	Grit	Shank Dia.	Max. RPM	Item #	Pkg. Qty
1" (25 MM) DIA. X 1" (25 MM) W	40	1/4" (6 MM)	30,000	78307	10
	60			78300	10
	80			78301	10
	120			78302	10
	180			78308	10
1-1/2" (38 MM) DIA. X 1" (25 MM) W	40	1/4" (6 MM)	25,000	78303	10
	60			78304	10
	80			78305	10
	120			78306	10
	180			78309	10
2" (51 MM) DIA. X 1" (25 MM) W	40	1/4" (6 MM)	25,000	78314	10
	60			78401	10
	80			78323	10
	120			78403	10
	180			78324	10

	Grit	Shank Dia.	Max. RPM	Item #	Pkg. Qty
2-1/2" (64 MM) DIA. X 1/2" (13 MM) W	80	1/4" (6 MM)	23,000	78404	10
3" (76 MM) DIA. X 1" (25 MM) W	40	1/4" (6 MM)	20,000	78339	10
	60			78410	10
	80			78375	10
	120			78412	10
	180			78413	10

SHAPE

USE WITH



DynaCut™ spindle mounted flap wheels are made with a fixed 1/4" steel shaft that runs completely through the wheel for better balance. The 1/4" shaft allows for quick changes on Dynabrade and other air tools fitted with a 1/4" collet.

COLLET



ARBOR



DynaCut™ arbor mount flap wheels are used with Dynabrade and other large straight shaft air tools.

FLAP WHEELS

SPINDLE MOUNTED INTERLEAF FLAP WHEELS

- DynaCut™ Aluminum Oxide Interleaf flap wheels are a 1:1 combination of coated abrasive and non-woven abrasive flaps. This combination makes them ideal for light deburring and cleaning of irregular shapes parts and inside pipe, tubing and cylinders. Also for removing scale and marks made by previous operations.



	Grit	Shank Dia.	Max. RPM	Item #	Pkg. Qty
1" (25 MM) DIA. X 1" (25 MM) W	60	1/4" (6 MM)	15,000	78676	10
	120			78456	10
	180			78677	10
2" (51 MM) DIA. X 1" (25 MM) W	60	1/4" (6 MM)	13,700	78325	10
	80			78405	10
	120			78326	10
	180			78327	10
3" (76 MM) DIA. X 1" (25 MM) W	60	1/4" (6 MM)	8,600	78328	10
	120			78329	10
	180			78330	10

TOOLS USED

.4 HP RIGHT ANGLE DIE GRINDER



.5 HP STRAIGHT-LINE DIE GRINDER



APPLICATION GUIDE

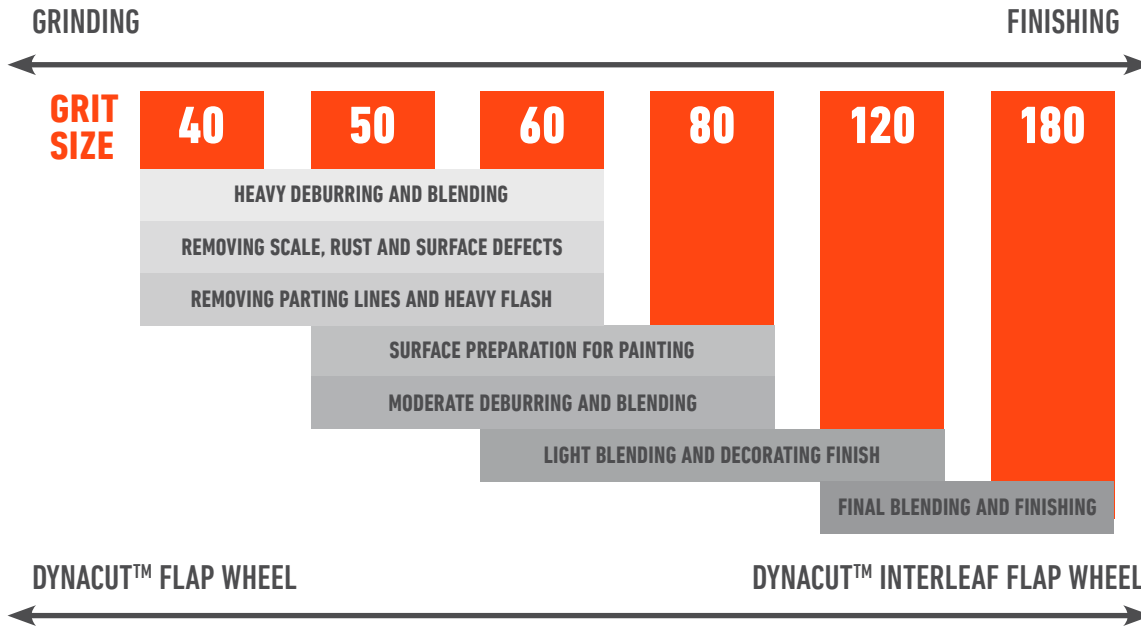

FLAP WHEELS

ARBOR MOUNT FLAP WHEELS WITH FLANGES

- DynaCut™ arbor mount flap wheels are made with permanently attached side flanges that firmly hold the coated abrasive flaps in place. Designed for finishing flat, concave and convex surfaces, arbor mount flap wheels are ideal for grinding and blending the inside or outside of tanks, containers and large diameter pipes. Other applications include finishing odd and irregular shaped parts such as handles, taps and molded parts; also for removing and cleaning weld seams.



	Grit	Center Hole	Max. RPM	Item #	Pkg. Qty
6" (152 MM) DIA. X 1" (25 MM) W	40	1" (25 MM)	5,700	78379	1
	60			78310	1
	80			78311	1
	120			78312	1
6" (152 MM) DIA. X 1-1/2" (38 MM) W	40	1" (25 MM)	5,700	78383	1
	80			78313	1
6" (152 MM) DIA. X 2" (51 MM) W	40	1" (25 MM)	5,700	78384	1
					1
					1

TOOLS USED



UNIVERSAL ARBOR KIT

- Mount abrasive wheels, discs, pneumatic wheels, sanding stars and other accessories to 3/8"-24, 1/2"-20 or 5/8"-11 male spindle tools, by using the combination of spacers and flanges that suits your application.

Accepts any Dynacushion® or accessory which has 5/8" bore from 1/2" to 3" wide, in 1/2" increments.

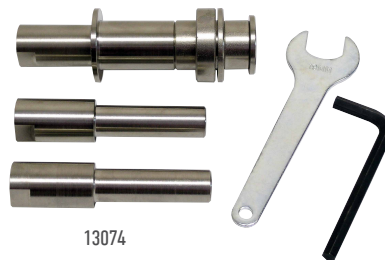

FLAP BRUSHES COATED ABRASIVES

FLAP BRUSHES

The Dynabrade flap brush line provides a wide range of unique cleaning and finishing solutions for in-line finishing and finish restoration on fabricated metals and unique sanding solutions on a broad range of other materials. Each of the Dynabrade flap brushes provide unique capabilities based on the combinations of abrasive type, grit size or grade from 100% coated abrasive flap brushes to interleaved coated and non woven flap brushes to 100% felt.

FLAP BRUSHES 85-91



FLAP BRUSHES FOR IN-LINE SANDING, FINISHING & POLISHING

For use on in-line sanding and finishing machines. Dynabrade offers a wide selection of premium coated, non-woven, and interleaved abrasive and felt polishing flap brushes.

Dynacut™ Flap Brushes are ideal for repairing, finishing and polishing large and small surface areas with Dynastraight® and Dynisher in-line finishing tools. The rotational in-line direction of the Dynacut™ Flap Brushes provides optimum results for “setting the grain” and fast linear surface finishing of flat surfaces versus the swirl pattern that is generated by discs. Common applications include finishing stainless steel fabricated assemblies, repairing surface damage from handling and assembly, to generating brushed to high gloss finishes in food, pharmaceutical, and chemical processing equipment.

ALUMINUM OXIDE

DYNACUT™ ALUMINUM OXIDE FLAP BRUSH

Manufactured in medium hardness with synthetic resin bonded Dynacut™ aluminum oxide abrasive flaps for general deburring, sanding, cleaning and finishing applications on nonferrous metals, carbon and stainless steels, composites, wood and plastics.

FEATURES

- 1 Features premium aluminum oxide abrasives
- 2 Strong X-weight backing
- 3 Durable, synthetic resin bond

BENEFITS

- For fast cut and long life.
- Provides uniform support of the abrasive grain and wears away evenly with the abrasive for consistent finishes.
- Holds the abrasive grain in place ensuring uniform wear of the abrasive flaps for long life and consistent performance.



INTERLEAVED

DYNACUT™ INTERLEAVED FLAP BRUSH

Manufactured with alternating flaps of Dynacut™ premium aluminum oxide coated abrasives and Dynabright® non-woven abrasive material, these medium density flap brushes are used to produce a brushed surface finish and for light deburring, cleaning and finishing in one step.

FEATURES

- 1 Features a 1:1 ration of premium aluminum oxide coated abrasive flaps and non-woven abrasive
- 2 Strong X-weight backing and durable, non-woven nylon abrasive flaps
- 3 Coated abrasive grit size and non-woven grade combinations

BENEFITS

- For fast effective one step finishing.
- Flaps wear away together for uniform finishes throughout the life of the flap roll.
- Precisely matched for optimum performance.



SURFACE CONDITIONING

DYNABRITE® FLAP BRUSH

Dynabrite® non-woven flap brushes are designed for generating satin finishes and are used in final brushing applications. A wide range of grades are available to meet virtually any finishing requirement.

FEATURES

- 1 Premium non-woven nylon abrasive flaps
- 2 Strong & flexible synthetic resin

BENEFITS

- For generating smooth, uniform and consistent brush finishes.
- Holds abrasive grain firmly throughout the open mesh non-woven web for longer product life.



ABRASIVE FLAP BRUSHES CONTINUED

FELT POLISHING

DYNABRITE® FELT POLISHING FLAP BRUSH (PATENTED)

Manufactured with wool felt flaps, these polishing flap rolls are designed to be used in combination with buffing or polishing compounds to produce up to mirror finishes.

FEATURES

- 1 Premium, flexible 70% natural wool felt flaps

BENEFITS

Runs cooler for longer usable life.



APPLICATION GUIDE

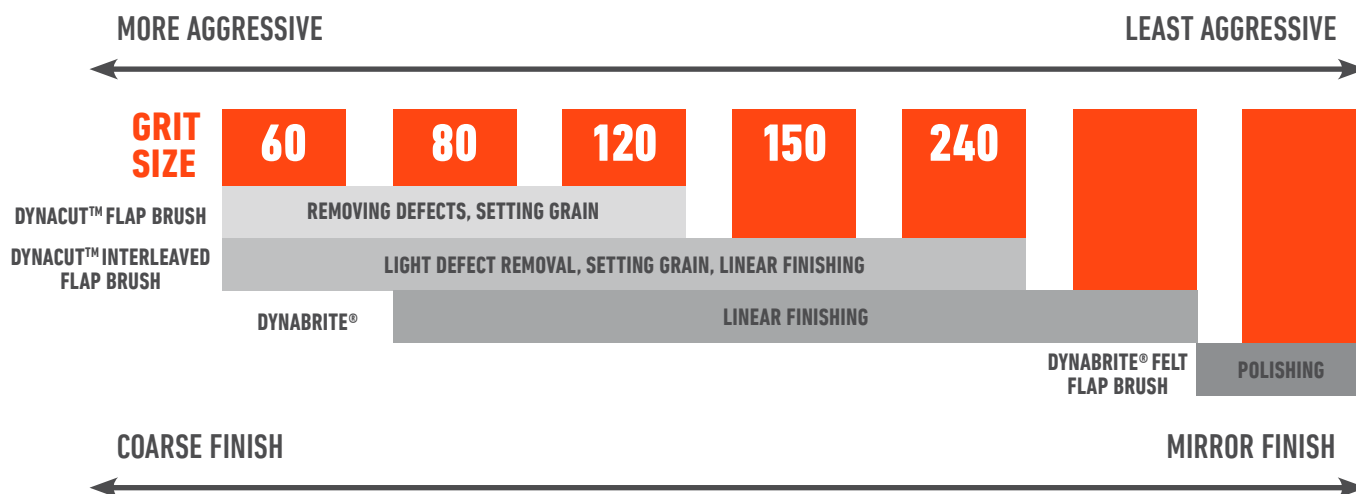

COMPETITOR CROSS REFERENCE FLAP BRUSHES



	COATED ABRASIVE	INTERLEAVED	NON-WOVEN	POLISHING
	Dynacut™ Flap Brushes	Dynacut™ Interleaved Flap Brushes	DynaBrite® Flap Brushes	DynaBrite® Felt Flap Brushes
3M	-	Scotchbrite™ Match and Finish Combi	Scotchbrite™ Match and Finish High Strength	-
WALTER	Coolcut™ Flap Drums	Two-In-One™ Drums	Blendex™ Drums	Buffing Drum
METABO	Flap Wheel	Flap/Nylon Web	Nylon Web Grinding Wheel	Felt Flap Rolls
CS UNITEC	PTX Flap Wheel	PTX Interleaf Wheel	PTX Fleece	-
CIBO	Finmaster Cloth	Finmaster Combi	Finmaster Tex	-

DYNISHER TOOL SERIES

SEE THE COMPLETE LINE AT DYNABRADE.COM



1 hp Dynisher



Dynisher



Mini-Dynisher



Versatility Kits

FLAP BRUSHES DYNACUT™ COATED FLAP BRUSHES

- Ideal for light metal removal and graining flat, concave and convex surfaces as a first step in an in-line finishing system.



Dia.	Width	Attachment	Max. RPM	Grit	Item #	Qty
4" (102 MM)	4" (102 mm)	3/4" Dia. Arbor (19 mm)	5,000	40	78376	1
				60	90847	1
				80	90851	1
				120	90852	1
4-1/4" (108 MM)	4" (102 mm)	5/8"-11 Thread		60	78678	1
				80	78679	1
				120	78680	1

TOOL USED

DYNISHER



13402

FLAP BRUSHES DYNABRITE® INTERLEAF COATED FLAP BRUSHES

- Combines two in-line finishing steps in one. The coated abrasive flaps provide light material removal with the Dynabrite® flaps generating a satin finish.



Dia.	Width	Attachment	Max. RPM	Grit/Grade	Item #	Qty	
4" (102 MM)	4" (102 mm)	3/4" Dia. Arbor (19 mm)	5,000	60/C	79470	1	
				80/M	79471	1	
				120/M	79472	1	
				150/F	79473	1	
				240/VF	79474	1	
4-1/4" (108 MM)	2" (51 mm)	5/8"-11 Thread	5,000	60/C	79476	1	
				80/M	79477	1	
				120/M	79478	1	
				180/F	79479	1	
	4" (102 mm)	5/8"-11 Thread	5,000		240/VF	79480	1
					60/C	79482	1
					80/M	79483	1
					120/M	79484	1
				150/F	79485	1	
				240/VF	79486	1	

TOOL USED

DYNISHER



13450







DYNASTRAIGHT®



13214

FLAP BRUSHES DYNABRITE® FINISHING FLAP BRUSHES

— Ideal for deburring, cleaning, blending and polishing on aluminum, steel, stainless steel and other metals.

	Dia.	Width	Attachment	Max. RPM	Grade	Item #	Qty	TOOLS USED
 ULTRA FINE	4" (102 MM)	4" (102 mm)	3/4" Dia. Arbor (19 mm)	5,000	Coarse	79404	1	— TOOLS USED ↓ DYNISHER  13402
					Medium	79405	1	
					Fine	79406	1	
					Very Fine	79407	1	
					Ultra Fine	79490	1	
 COARSE  MEDIUM	4-1/4" (108 MM)	2" (51 mm)	5/8"-11 Thread	5,000	Coarse	79493	1	DYNASTRAIGHT®  13204 DYNASTRAIGHT®  13214
					Medium	79494	1	
					Fine	79400	1	
		Very Fine	79401	1				
		Ultra Fine	79489	1				
		4" (102 mm)	5/8"-11 Thread	5,000	Coarse	79491	1	
					Medium	79492	1	
					Fine	79402	1	
		Very Fine	79403	1				
Ultra Fine	79487	1						

ABRASIVE GRIT KEY

- Extra Coarse
- Coarse
- Medium
- Fine
- Very Fine
- Super Fine

FLAP BRUSHES DYNABRITE® FELT POLISHING FLAP BRUSHES

- Ideal for generating mirror finishes on aluminum, stainless steel and other metals.



Dia.	Width	Attachment	Max. RPM	Mineral	Item #	Qty
4" (102 MM)	2" (51 mm)	3/4" Dia. Arbor (19 mm)	5,000	Felt	79481	1
	4" (102 mm)		3,700		79475	1
4-1/4" (108 MM)	4" (102 mm)	5/8"-11 Thread	5,000	Felt	79488	1

TOOLS USED

DYNISHER



13402

DYNASTRAIGHT®



13511

DYNASTRAIGHT®



13521

DYNISHER

ABRASIVE FINISHING TOOL



- Achieve consistent finishes along a 90° seam.
- Newly designed models allow for use with up to 4" wide flap wheels with 5/8"-11" threaded hub.
- The Dynisher is ideal for in-line graining, blending and polishing applications.
- Dynishers are ideally suited for use on metals but can also be used on a variety of other substrates including woods, plastics and composites.

TECH TIP

Slow speed Dynishers typically produce deep, long scratches, while higher speed models create shallow, short scratches.

MICROFINISHING & LAPPING ROLLS

COATED ABRASIVES

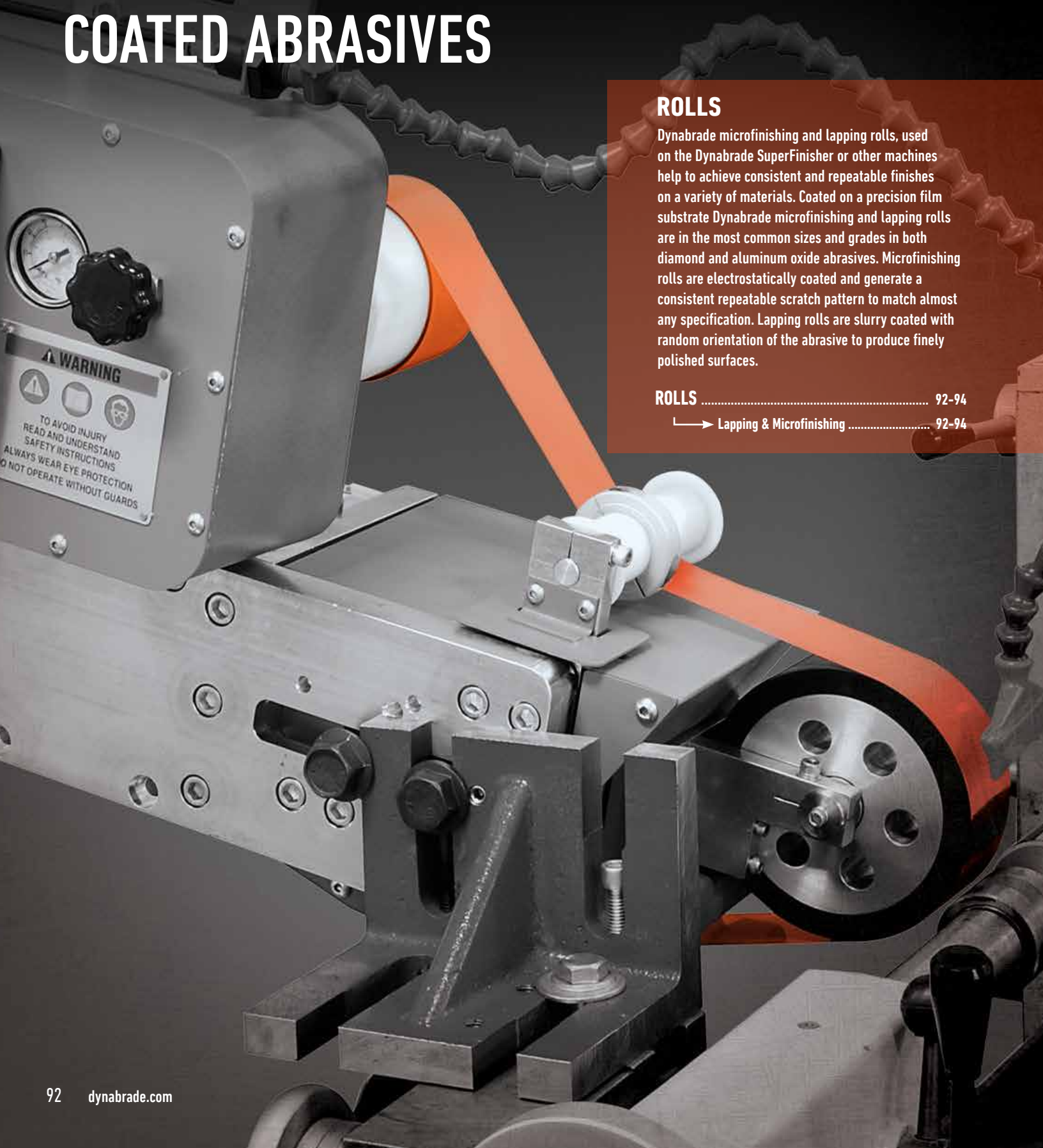

ROLLS

Dynabrade microfinishing and lapping rolls, used on the Dynabrade SuperFinisher or other machines help to achieve consistent and repeatable finishes on a variety of materials. Coated on a precision film substrate Dynabrade microfinishing and lapping rolls are in the most common sizes and grades in both diamond and aluminum oxide abrasives. Microfinishing rolls are electrostatically coated and generate a consistent repeatable scratch pattern to match almost any specification. Lapping rolls are slurry coated with random orientation of the abrasive to produce finely polished surfaces.

ROLLS	92-94
↳ Lapping & Microfinishing	92-94

MICROFINISHING & LAPPING ROLLS

For use on Dynabrade SuperFinisher to achieve predictable, consistent and repeatable finishes on a variety of materials. Microfinishing film rolls consist of electrostatically oriented abrasive for an aggressive cut. Lapping film rolls consist of randomly oriented abrasive for a finer finish.

DIAMOND MICROFINISHING FILM ROLLS

Roll Length	Roll Width	Micron	Item #	Pkg. Qty
50'	1"	60μ	92728	1
		40μ	•	1
		30μ	92730	1
		20μ	•	1
50'	2"	60μ	92744	1
		40μ	92745	1
		30μ	92746	1
		20μ	92747	1
50'	3"	60μ	92760	1
		40μ	92761	1
		30μ	92762	1
		20μ	92763	1
50'	4"	60μ	92776	1
		40μ	92777	1
		30μ	92778	1
		20μ	92779	1

• Call for availability and pricing.

DIAMOND LAPPING FILM ROLLS

Roll Length	Roll Width	Micron	Item #	Pkg. Qty
50'	1"	60μ	92732	1
		40μ	•	1
		30μ	92734	1
		20μ	•	1
50'	2"	60μ	92748	1
		40μ	92749	1
		30μ	92750	1
		20μ	92751	1
50'	3"	60μ	92764	1
		40μ	92765	1
		30μ	92766	1
		20μ	92767	1
50'	4"	60μ	•	1
		40μ	92781	1
		30μ	92782	1
		20μ	92783	1

• Call for availability and pricing.



SUPERFINISHER MODEL 64000

ADJUSTABLE ABRASIVE ROLL FEED

Adjustable from 1/6" to 1-1/2" per minute, allowing abrasive to be fully consumed, eliminating waste of expensive abrasives.

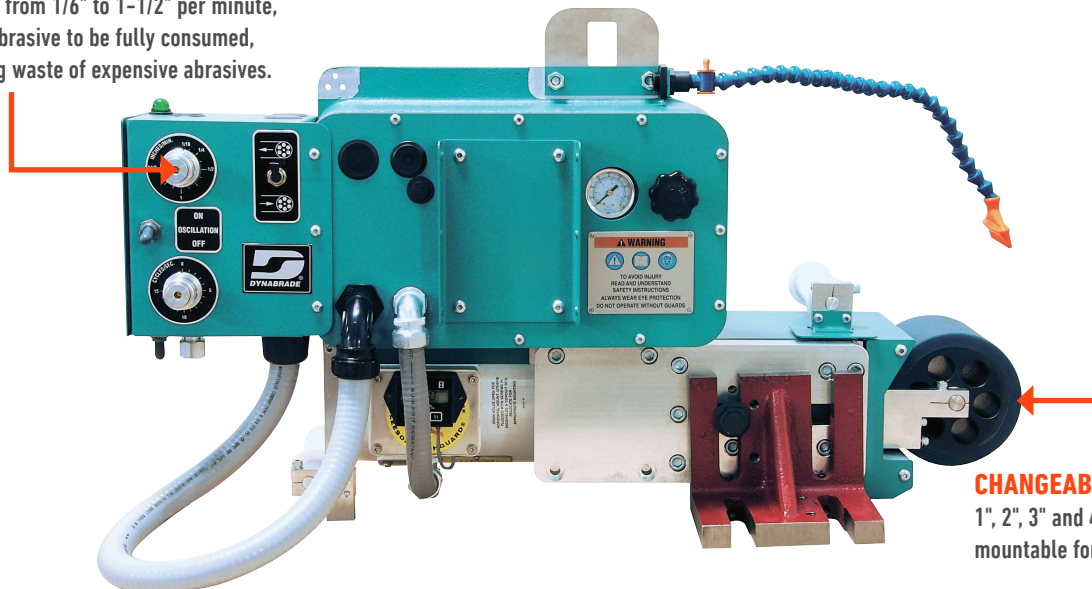

CHANGEABLE CONTACT WHEELS

1", 2", 3" and 4" Contact Wheels are mountable for a variety of applications.

MICROFINISHING & LAPPING ROLLS

ALUMINUM OXIDE MICROFINISHING FILM ROLLS

Roll Length	Roll Width	Micron	Item #	Pkg. Qty
150'	1"	60μ	•	1
		30μ	92721	1
		15μ	•	1
		9μ	•	1
150'	2"	60μ	92736	1
		30μ	92737	1
		15μ	92738	1
		9μ	•	1
150'	3"	60μ	•	1
		30μ	•	1
		15μ	92754	1
		9μ	92755	1
150'	4"	60μ	92768	1
		30μ	92769	1
		15μ	92770	1
		9μ	92771	1

ALUMINUM OXIDE LAPPING FILM ROLLS

Roll Length	Roll Width	Micron	Item #	Pkg. Qty
150'	1"	30μ	92724	1
		15μ	92725	1
		9μ	92726	1
		3μ	92727	1
150'	2"	30μ	92740	1
		15μ	•	1
		9μ	92742	1
		3μ	92743	1
150'	3"	30μ	92756	1
		15μ	92757	1
		9μ	92758	1
		3μ	92759	1
150'	4"	30μ	92772	1
		15μ	•	1
		9μ	•	1
		3μ	92775	1



COOLANT FILTRATION SYSTEM MODEL 68000



DYNABRITE® NON-WOVEN ABRASIVES

DynaBrite® Abrasives - Consist of several categories of non-woven abrasives that deliver solutions geared to providing optimum performance in stripping, blending, deburring, finishing and polishing applications.

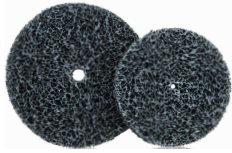

DYNASTRIP™

Heavy duty discs and wheels for cleaning, stripping and removing coatings or scale on a wide range of materials.



DYNAPREP™ SCM

Surface conditioning material discs and belts for better material removal, long life and consistent finishes



DYNABLEND™ UNITIZED

Unitized discs and wheels for quick blending and polishing.



DYNAFINISH™ CONVOLUTE

Convolute wheels that provide consistent finishes, uniform cut rate and long life.



DYNABRITE®

May be used by hand, or attached to an in-line or jitterbug-type sander. Ideal for graining, denibbing, defuzzing, and rust removal.

NON-WOVEN ABRASIVES

Dynabrite™ non-woven abrasives are three dimensional abrasives composed of abrasive grains dispersed throughout a web of interlocking polyester or nylon fibers that are bonded together with synthetic resins. The abrasive grain and resin bond is dispersed through the open weave construction providing a continuous supply of new abrasive grain as fibers and old grain wear away. Non-wovens are made into many forms that can conform to uneven surfaces, provide consistent finishes on a wide range of materials and can be used for stripping coatings, rust or other surface contaminants.

BELTS 95-101



NON-WOVEN ABRASIVE BELTS

Surface conditioning belts are a combination of a strong, low-stretch, synthetic mesh or woven cloth backing and quality abrasives bonded together by flexible yet tough adhesives. The open construction of the non-woven surface generates an aggressive cutting action, provides non-loading performance and generates improved surface finishes. Belts are coated with aluminum oxide in coarse, medium, very fine, and silicon carbide in superfine.

APPLICATION GUIDE

	EXTRA COARSE	COARSE	MEDIUM	FINE	VERY FINE	SUPER FINE
DYNAPREP™ - PREMIUM PLUS						
DYNAPREP™ - PREMIUM						
DYNAPREP™						
Scale Removal	█					
Stock Removal		█				
Heavy Deburring		█				
Light Deburring			█			
Light Finishing			█			
Blending				█		
Finishing					█	█

ABRASIVE GRIT KEY



DYNAPREP™ PREMIUM PLUS

The BEST choice for all finishing and blending applications. Provides the lowest total cost of consumable tooling.

FEATURES

- This premium surface conditioning material utilizes sharp heat treated aluminum oxide abrasive** →
- Proprietary resin technology** →
- Most consistent cutting and finishing surface conditioning material available** →
- More resistant to edge wear** →
- Thicker layer of grain is evenly dispersed throughout the product surface, not just coated on top** →

BENEFITS

- Maintains RA specifications throughout product life, reducing scrap and rework.
- "Smear free" even on high nickel content alloys.
- Resists loading on aluminum or other soft materials.
- Can provide up to 2 times the life of competitive products.
- Can reduce processing time by 50% or greater.



1

DYNAPREP™ PREMIUM

The BETTER choice for finishing and blending applications that demand a higher performance product.

FEATURES

- High-performance aluminum oxide, smear resistant resin and durable cloth mesh backing** →

BENEFITS

- Provides an aggressive cutting action that reduces cycle times.



2

DYNAPREP™

The GOOD choice for all finishing and blending applications on a variety of materials.

FEATURES

- 2-Dimensional, open structure, non-woven surface conditioning material coated throughout with Aluminum Oxide abrasive in the coarse, medium and very fine grades** →
- Coated with silicon carbide abrasive in the superfine grade** →

BENEFITS

- For a long life and consistent finishes on ferrous and nonferrous metals.
- For generating bright final finishes on ferrous and nonferrous metals.







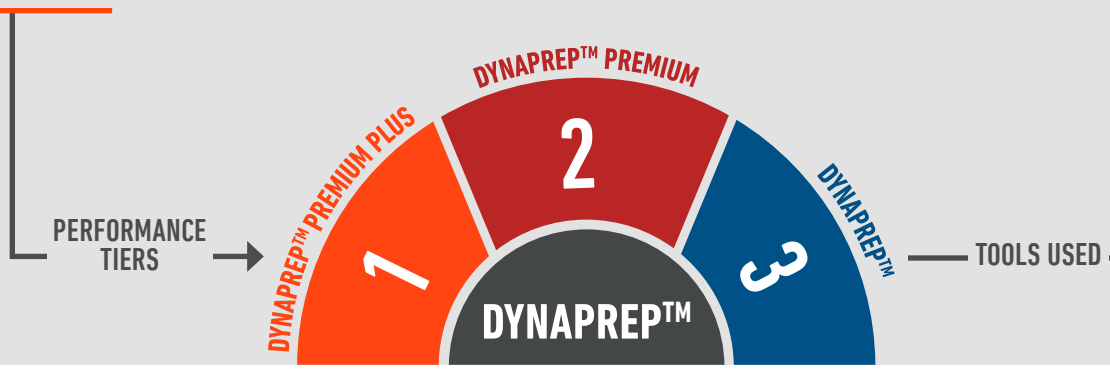

3

DYNAPREP™ 11" & 12" NON-WOVEN ABRASIVE BELTS



ABRASIVE GRIT KEY

-  Extra Coarse
-  Coarse
-  Medium
-  Fine
-  Very Fine
-  Super Fine



Length	Width	Grade	Item #	Item #	Item #	10Qty10
11" (279 MM)	1" (25 mm)	Coarse			79554	10
		Medium		79547		10
		Very Fine		79543		10
12" (305 MM)	1/4" (6 mm)	Coarse	79500			10
		Medium	79501			10
		Very Fine	79502			10
	1/2" 13 mm)	Coarse	79512	90314	78006	10
		Medium	79513	90313	78007	10
		Very Fine	79514	90312	78008	10
		Super Fine		90311	78009	10



Seen here are two examples of strap polishing with the Dynaflex® II & Mini-Dynaflex® II abrasive belt tools. Slack created by the offset arm allows belts to conform to a contoured work surface while blending and polishing without undercutting.

DYNAPREP™ 18" NON-WOVEN ABRASIVE BELTS

ABRASIVE GRIT KEY

-  Extra Coarse
-  Coarse
-  Medium
-  Fine
-  Very Fine
-  Super Fine

PERFORMANCE TIERS



TOOLS USED

Length	Width	Grade	Item #	Item #	Item #	10Qty10
18" (457 MM)	1/4" (6 mm)	Coarse	79504	90231	78015	101010
		Medium	79505	90229	78016	101010
		Very Fine	79506	90228	78017	10
		Super Fine			78018	10
	1/2" (13 mm)	Coarse	79516	90297	78019	10
		Medium	79517	90292	78020	10
		Very Fine	79518	90248	78021	10
		Super Fine			78022	10
	3/4" (19 mm)	Coarse	79528	90299	78024	10
		Medium	79529	90294	78025	10
		Very Fine	79530	90258	78026	10
		Super Fine			78027	10
1" (25 mm)	Coarse	79532	90300	78029	10	
	Medium	79533	90295	78030	10	
	Very Fine	79534	90259	78031	10	
	Super Fine			78032	10	

DYNAFILE® II



DYNAFILE® III



DYNABRADE BELT TOOL VERSATILITY

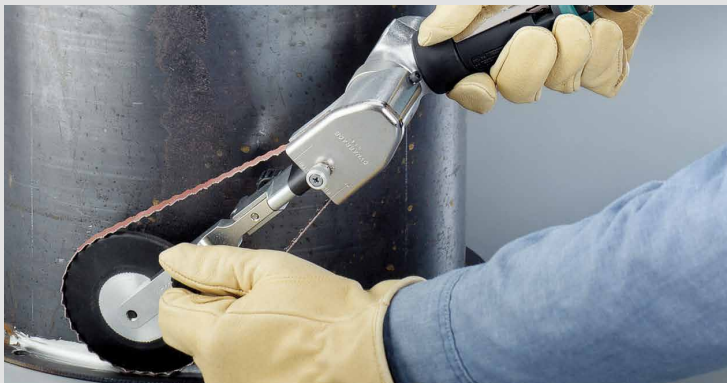

40353 Dynafile® II (.4 hp) is designed for exclusive use with non-woven nylon belts. This tool is excellent for setting grain lines, achieving consistent satin finishes, and removing oxide or weld discoloration. Shown with optional 11204 Contact Arm, with offset design ideal for slack polishing.



DYNAPREP™ 20-1/2" & 24" NON-WOVEN ABRASIVE BELTS

ABRASIVE GRIT KEY

	Extra Coarse
	Coarse
	Medium
	Fine
	Very Fine
	Super Fine

PERFORMANCE TIERS



TOOLS USED



Length	Width	Grade	Item #	Item #	Item #	Qty
20-1/2" (521 MM)	3/4" (19 mm)	Coarse			78124	10
		Medium			78119	10
		Very Fine			78118	10
24" (610 MM)	1/4" (6 mm)	Coarse	79508	90460	78045	10
		Medium	79509	90433	78046	10
		Very Fine	79510	90403	78047	10
		Super Fine			78048	10
	1/2" 13 mm)	Coarse	79520	90461	78049	10
		Medium	79521	90434	78050	10
		Very Fine	79522	90400	78051	10
		Super Fine			78052	10
	1" (25 mm)	Coarse	79536	90462	78054	10
		Medium	79537	90416	78055	10
		Very Fine	79538	90402	78056	10
		Super Fine			78057	10

DYNAFILE® II



DYNAFILE®



DYNAFILE® III





COMPETITIVE CROSS REFERENCE

	DYNAPREP™ PREMIUM PLUS	DYNAPREP™ PREMIUM	DYNAPREP™
3M SC-DS	1	2	3
3M SE-DS			
SIA B TYPE			
SIA C TYPE			
BIIBIELLE SCSB			
BIIBIELLE SCHD			
STANDARD GP-DS			

DYNAPREP™ 30" NON-WOVEN ABRASIVE BELTS

ABRASIVE GRIT KEY

-  Extra Coarse
-  Coarse
-  Medium
-  Fine
-  Very Fine
-  Super Fine

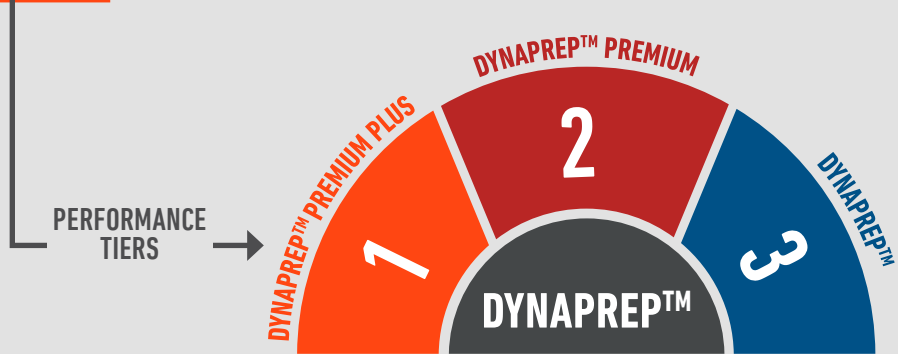

Length	Width	Grade	Item #	Item #	Item #	Qty
30" (762 MM)	1/2" (13 mm)	Coarse	•	90442	78063	10
		Medium	•	90436	78064	10
		Very Fine	•	90406	78065	10
	1" (25 mm)	Coarse	•	90444	78066	10
		Medium	•	90437	78067	10
		Very Fine	•	90401	78068	10
	1-1/2" (38 mm)	Coarse	79591	•	78033	10
		Medium	79592	•	78034	10
		Very Fine	79593	•	78035	10
2" (51 mm)	Coarse	•	90448	78069	10	
	Medium	•	90438	78070	10	
	Very Fine	•	90414	78071	10	

• Call for availability and pricing.

TOOLS USED

DYNABELTER®



PIPE BELT FINISHER

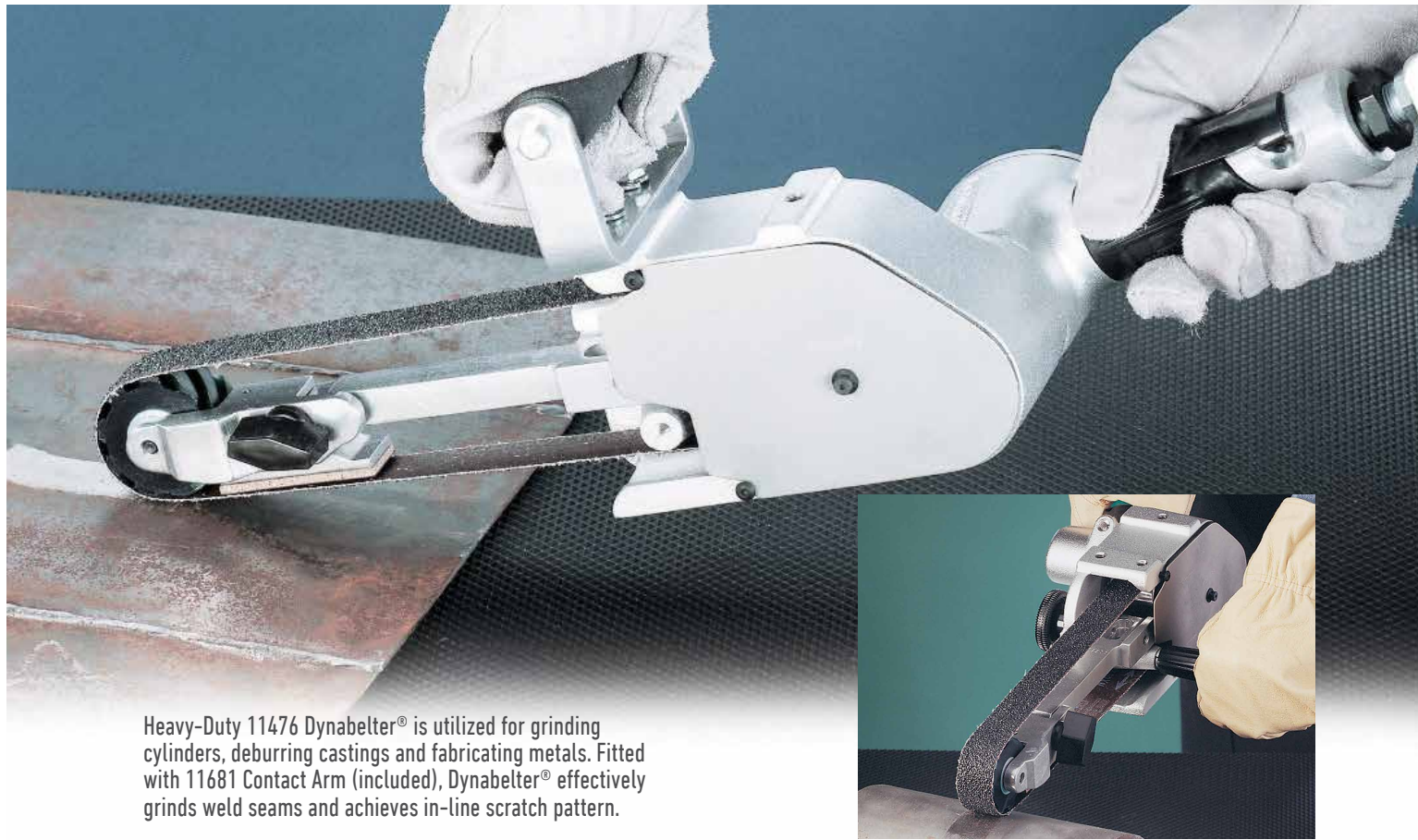
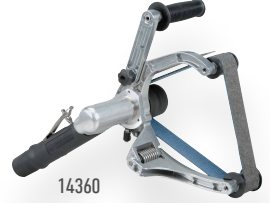

Heavy-Duty 11476 Dynabelter® is utilized for grinding cylinders, deburring castings and fabricating metals. Fitted with 11681 Contact Arm (included), Dynabelter® effectively grinds weld seams and achieves in-line scratch pattern.

DYNAPREP™ 34", 48", 60" & 72" NON-WOVEN ABRASIVE BELTS

ABRASIVE GRIT KEY

	Extra Coarse
	Coarse
	Medium
	Fine
	Very Fine
	Super Fine

PERFORMANCE TIERS



TOOLS USED



Length	Width	Grade	Item #	Item #	Item #	Qty
34" (864 MM)	3/4" (19 mm)	Coarse		•	78117	10
		Medium		•	78116	10
		Very Fine		•	78115	10
	2" (51 mm)	Coarse		90374	78075	10
		Medium		90373	78076	10
		Very Fine		90371	78077	10
48" (122 CM)	2" (51 mm)	Coarse			81237	10
		Medium			81238	10
		Very Fine			81239	10
60" (152 CM)	2" (51 mm)	Coarse			81242	10
		Medium			81243	10
		Very Fine			81244	10
72" (183 CM)	1/2" (13 mm)	Coarse			78086	10
		Medium			78087	10
		Very Fine			78088	10
	1" (25 mm)	Coarse			78090	10
		Medium			78091	10
		Very Fine			78092	10
	2" (51 mm)	Coarse			78080	10
		Medium			78081	10
		Very Fine			78082	10

• Call for availability and pricing.

DYNANGLE II



BENCH GRINDER



VERSATILITY GRINDER



DYNAPREP™ EXPANDING DRUM BELTS

ABRASIVE GRIT KEY

	Extra Coarse
	Coarse
	Medium
	Fine
	Very Fine
	Super Fine

PERFORMANCE TIERS



TOOLS USED



Length	Width	Grade	Item #	Item #	Item #	Qty
7-3/8" (187 MM)	3" (76 mm)	Medium			90092	1
		Very Fine			90091	1
9-3/4" (248 MM)	2-1/4" (57 mm)	Medium			90095	1
		Very Fine			90094	1
10-11/16" (272 MM)	3" (76 mm)	Coarse		89213	90239	1
		Medium		89212	90238	1
		Very Fine		89211	90237	1
	7" (178 mm)	Coarse			90099	1
		Medium			90098	1
		Very Fine			90097	1
15-1/2" (394 MM)	1" (25 mm)	Coarse		•	78078	10
		Medium		•	78079	10
		Very Fine		•	78094	10
	1-1/2" (38 mm)	Coarse		•	78095	10
		Medium		•	78096	10
		Very Fine		•	78097	1
	2" (51 mm)	Coarse		•	79322	1
		Medium		•	79323	1
		Very Fine		•	79324	1
	2-3/4" (70 mm)	Coarse		89233	90023	1
		Medium		89232	90022	1
		Very Fine		89231	90021	1
3-1/2" (89 mm)	Coarse		89243	90283	1	
	Medium		89242	90282	1	
	Very Fine		89241	90281	1	

DYNASTRAIGHT®



13515

ROLLING PIN SANDER



58050

DYNISHER



13400

DISCS

NON-WOVEN ABRASIVES

NON-WOVEN ABRASIVE DISCS

Non-Woven abrasive discs provide light grinding, blending and finishing solutions on a wide range of applications. The Dynabrade non woven disc line includes Dynaprep™ quick change locking discs and center hole discs, DynaBlend™ unitized discs , Dynabrite® high strength discs and hook and loop discs and DynaStrip™ surface stripping discs.

DISCS	102-109
↳ Locking Discs	105
↳ Center Hole Discs	106
↳ Unitized Discs	107
↳ Hook & Loop Discs	108
↳ High Strength Arbor Hole Discs	108
↳ Dynastrip™ Discs	109

DYNAPREP™ DISCS

DynaPrep™ discs are an excellent choice for cleaning and surface preparation prior to applying coatings, for cleaning welds, blending mismatch on machined parts and light deburring of ferrous and nonferrous metals. Additionally, DynaPrep™ discs excel at creating decorative finishes and in polishing applications where part conformability is required.

DynaPrep™ SCM surface conditioning discs are available in sizes, configurations and attachment types to fit a wide range of Dynabrade and other high speed die grinders and angle grinders. DynaPrep™ discs are stocked in locking-type discs with TR attachment for quick change on die grinders, standard 7/8" center hole for use with back-up pads and hook and loop attachment for use with hook-face back-up pads.

APPLICATION GUIDE	EXTRA COARSE	COARSE	MEDIUM	FINE	VERY FINE	SUPER FINE
Scale Removal	Black					
Stock Removal		Brown				
Heavy Deburring		Brown				
Light Deburring			Dark Red			
Light Finishing			Dark Red			
Blending				Green		
Finishing					Blue	Grey

*Surface conditioning material grades are generally identifiable by their color. Seen here are typical applications and their recommended material coarseness along with the corresponding material color.

COMPETITIVE CROSS REFERENCE

	DYNAPREP™ PREMIUM PLUS	DYNAPREP™ PREMIUM	DYNAPREP™
3M SC-DS	1	2	3
3M SE-DS			
SIA B TYPE			
SIA C TYPE			
BIIBIELLE SCSB			
BIIBIELLE SCHD			
STANDARD GP-DS			



EXTRA COARSE



FINE



COARSE

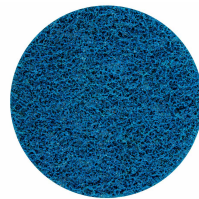

VERY FINE

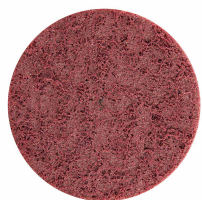

MEDIUM



SUPER FINE

DYNAPREP™ SURFACE CONDITIONING MATERIAL

Surface conditioning material is a combination of a strong, low-stretch synthetic mesh or woven cloth backing, an open, non-woven web and quality abrasives bonded together by durable adhesives. The abrasive saturated open web construction generates an aggressive cutting action, provides non-loading performance and generates improved surface finishes.

DYNAPREP™ PREMIUM PLUS

The BEST choice for all finishing and blending applications. Provides the lowest total cost of consumable tooling.

FEATURES

- 1 This premium surface conditioning material utilizes sharp heat treated aluminum oxide abrasive
- 2 Proprietary resin technology
- 3 Most consistent cutting and finishing surface conditioning material available
- 4 More resistant to edge wear
- 5 Thicker layer of grain is evenly dispersed throughout the product surface, not just coated on top

BENEFITS

- Maintains RA specifications throughout product life, reducing scrap and rework.
- "Smear free" even on high nickel content alloys.
- Resists loading on aluminum or other soft materials.
- Can provide up to 2 times the life of competitive products.
- Can reduce processing time by 50 % or greater.



1

DYNAPREP™ PREMIUM

The BETTER choice for finishing and blending applications that demand a higher performance product.

FEATURES

- 1 High-performance aluminum oxide, smear resistant resin and durable cloth mesh backing

BENEFITS

- Provides an aggressive cutting action that reduces cycle times.



2

DYNAPREP™

The GOOD choice for all finishing and blending applications on a variety of materials.

FEATURES

- 1 2-Dimensional, open structure, non-woven surface conditioning material coated throughout with Aluminum Oxide abrasive in the coarse, medium and very fine grades
- 2 Coated with silicon carbide abrasive in the superfine grade

BENEFITS



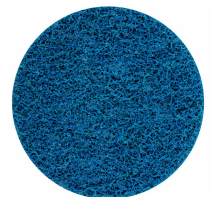



- For a long life and consistent finishes on ferrous and nonferrous metals.
- For generating bright final finishes on ferrous and nonferrous metals.



3

DYNAPREP™ LOCKING DISCS

ABRASIVE GRIT KEY

-  Extra Coarse
-  Coarse
-  Medium
-  Fine
-  Very Fine
-  Super Fine

PERFORMANCE TIERS



TOOLS USED

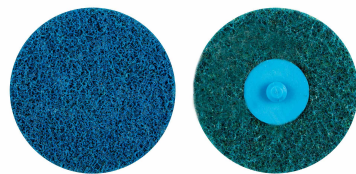
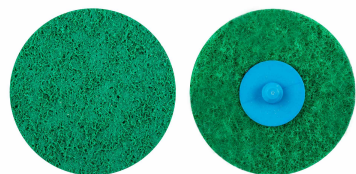
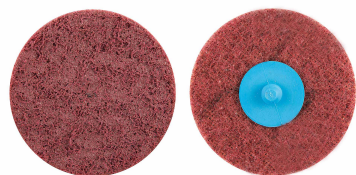
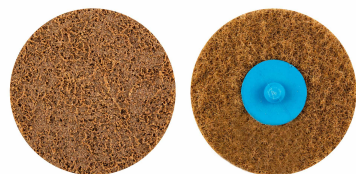

Dia.	Grade	Item #	Item #	Item #	Qty
1" (25 MM)	Coarse	93576	-	-	25
	Medium	93575	-	-	25
	Very Fine	93574	-	-	25
1-1/2" (38 MM)	Coarse	-	90861	-	25
	Medium	-	90859	-	25
	Very Fine	-	90857	-	25
2" (51 MM)	Extra Coarse	78174	-	-	25
	Coarse	78175	-	78123	25
	Medium	78176	-	78122	25
	Fine	78177	-	-	25
	Very Fine	78178	-	78121	25
	Super Fine	-	-	78120	25
3" (76 MM)	Extra Coarse	78185	-	-	25
	Coarse	78128	-	-	25
	Medium	78127	78182	-	25
	Fine	78126	78183	-	25
	Very Fine	78125	78184	-	25
4" (76 MM)	Extra Coarse	78155	-	78130	25
	Coarse	78152	-	78131	25
	Medium	78140	-	78132	25

**RIGHT ANGLE
MINI-DYNORBITAL®**



53415

.4 HP, 2" DISC SANDER



48520



.7 HP, STEEL DISC SANDER



54421

DYNAPREP™ CENTER HOLE DISCS

ABRASIVE GRIT KEY

-  Extra Coarse
-  Coarse
-  Medium
-  Fine
-  Very Fine
-  Super Fine

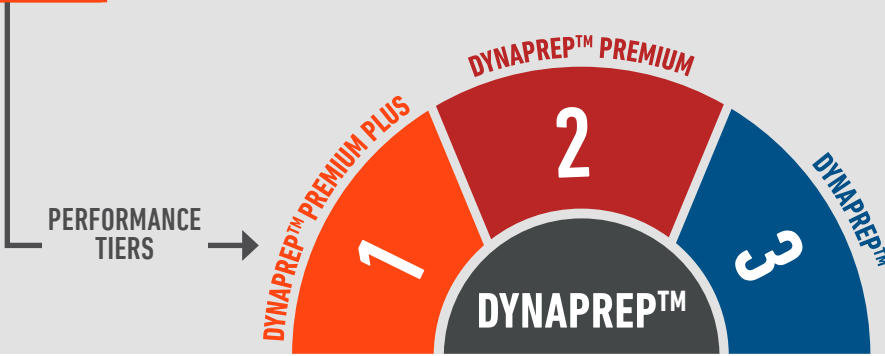

TOOLS USED →

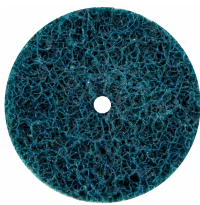

Dia.	Center Hole	Grade	Item #	Item #	Item #	Qty
4-1/2" (114 MM)	3/8" (10 mm)	Coarse			78425	25
		Medium			78424	25
		Very Fine			78423	25
5" (127 MM)	7/8" (22 mm)	Coarse			78343	25
		Medium			78344	25
		Very Fine			78345	25

PISTOL GRIP DISC SANDER



1.3 HP, 5" DISC SANDER



DYNAPREP™ HOOK AND LOOP DISCS

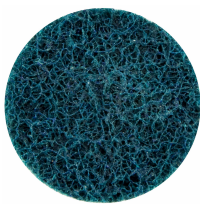

Dia.	Grade	Item #	Item #	Item #	Qty
5" (127 MM)	Coarse			78414	25
	Medium			78415	25
	Very Fine			78416	25
6" (152 MM)	Coarse			78417	25
	Medium			78418	25
	Very Fine			78419	25
7" (178 MM)	Coarse			78420	25
	Medium			78421	25
	Very Fine			78422	25

TOOLS USED →

PISTOL GRIP DISC SANDER



.4 HP, 2" DISC SANDER



DYNABLEND™ UNITIZED LOCKING-TYPE DISCS

DynaBlend™ unitized discs are a 3 dimensional abrasive made from highly compressed layers of non-woven web, saturated with specialized smear resistant resin and premium abrasives. Unitized discs can generate moderate to light stock removal and achieve excellent finishes using their edges and face to deburr, blend and polish a wide range of surfaces and surface shapes on nonferrous and ferrous metals, exotic metals and alloys, composites and glass. DynaBlend™ unitized discs are available in locking-type attachment for use on high speed die grinders with Type-R back-up pads as well as with fiberglass backplate for use on right angle grinders.



Dia.	Density/Grade	Item #	Item #	Qty
2" (51 MM)	2A Medium	78291		10
	6A Medium	78292		10
	2S Fine		78290	10
3" (76 MM)	2A Medium	78294		10
	6A Medium	78295		10
	2S Fine		78293	10

TOOLS USED

.4 HP DIE GRINDER



48317

ABRASIVE MINERAL KEY

- Aluminum Oxide
- Silicon Carbide

.7 HP DIE GRINDER



54343

.4 HP DISC SANDER



47821

.7 HP DISC SANDER



52410

COMPETITOR CROSS REFERENCE GUIDE



	DYNABLEND™
3M	EXL Unitized
NORTON	Rapid Blend
STANDARD	500-900 Series Unitized
SUPERIOR	XL Unitized
PFERD	PNER Unitized
BIBIELLE	BUR Unitized
MERIT	Deburring and Blending



DynaBlend™ discs are intended to be used on disc sanders with a locking-type back-up pad directly threaded to the tool spindle. Operators will experience greater control and less vibration using a disc sander. Using a stem mounted backup pad allows DynaBlend™ unitized discs to be adapted for use on die grinders. Dynabrade manufactures both disc sanders and die grinders in a range of motor sizes and speeds able to efficiently and safely power DynaBlend™ unitized discs.

DYNAPREP™ CENTER HOLE DISCS

DynaBrite™ high-strength arbor hole discs features a non-woven abrasive web that is firm and durable, yet tough and conformable. Using high-performance abrasives and smear-resistant resin bond, DynaBrite™ combats tearing on burrs and sharp edges. Whether used alone or ganged together to form a wheel DynaBrite™ discs are an ideal choice for removal of rust, oxides or coatings, polishing pipe OD and ID, cleaning castings, gasket removal, blending out surface imperfections and handling marks, surface preparation for soldering, cleaning angles and odd shapes without changing part profiles. DynaBrite™ high-strength discs will not stretch or shed during use.



Dia.	Grade	Center Hole	Item #	Qty
4" (102 MM)	Very Fine		78411	25
5" (127 MM)	Medium	1/4"	93098	25
7" (178 MM)	Medium		93099	25

TOOL USED



LIGHTWEIGHT DYNINGER

52050

ABRASIVE MINERAL KEY

- Aluminum Oxide
- Silicon Carbide

ARBORS



12995



12980

DYNABRITE™ HOOK AND LOOP DISCS

DynaPrep™ hook and loop discs are made from high-performance, non-woven abrasives in the most common diameters in conventional round and as well as scalloped edge for specialized applications. Used on Dynabrade random orbital sanders, DynaPrep™ non-woven hook and loop discs are an ideal solution for surface conditioning, decorative finishing, light to heavy cleaning, blending and polishing on a wide variety of materials and surfaces including bare wood, metal, man-made solid surfaces, as well as between coats of primer, sealers and other coatings. Scalloped edge discs, when paired with radius edge pads, conform to the shape of backsplash corners, counter top coves, bowls, sinks, rounded fiberglass corners and other complex shaped surfaces.



Dia.	Grade	Item #	Item #	Qty
3-1/2" (89 MM)	Medium	92585		10
	Fine	92586		10
5" (127 MM)	Medium	92595		10
	Fine	92596		10
	Medium	92605		10
	Fine	92606		10
11-1/4" (286 MM)	Medium	78249		10
	Very Fine	78250		10
	Fine		78251	10
	Ultra Fine	78252		10

TOOLS USED



DYNORBITAL®- SPIRIT

59020



59015

GEAR-DRIVEN SANDER



58040

DYNASTRIP™

DynaStrip™ discs are made from a slightly compressed, tough, non-woven web that is saturated with specialized resins and extra coarse abrasives. This formulation forms a very open structured disc that will not load on soft metals or when removing sticky coatings. Additionally, DynaStrip™ discs won't snag or shed like a traditional coated abrasive cloth or fiber disc when stripping & cleaning weld beads, burrs from edges, heavy scale and rust encased surfaces. Being a 3D structure it can be used on edge as well as its face and is extremely versatile as a removal and finishing tool that won't gouge or cause rework.

DynaStrip™ discs are available from 2" to 6" diameter with standard 1/2" arbor hole for use with mandrel part no. 95479 on straight line die grinders and sanders. DynaStrip™ discs can be mounted individually or ganged to form a wider abrasive surface. Also available mounted to stiff fiberglass backings with standard 7/8" arbor hole for use on right angle grinders.

DYNASTRIP™ LOCKING DISCS



Dia.	Width	Grade	Mineral	Item #	Item #	Item #	Qty
2" (51 MM)	1/2" (13 mm)	Extra Coarse	SIC			78206	1
			C/A	78402			1
3" (76 MM)	1/2" (13 mm)	Extra Coarse	C/A	78380			1

— TOOL USED

↓
.4 HP
DISC SANDER



ABRASIVE MINERAL KEY

	Ceramic Alumina
	Aluminum Oxide
	Silicon Carbide

DYNASTRIP™ 1/2" CENTER HOLE DISCS



Dia.	Width	Grade	Mineral	Item #	Item #	Item #	Qty
4" (102 MM)	1/2" (13 mm)	Extra Coarse	SIC			78141	1
5" (127 MM)	1/2" (13 mm)	Extra Coarse	SIC			78142	1
6" (152 MM)	1/2" (13 mm)	Extra Coarse	SIC			78143	1
			A/O		78381		1

— TOOL USED

↓
DYNASTRAIGHT®



TECH TIP
Apply firm pressure to strip and remove coatings, scale and rust and light pressure to generate finishes similar to that of a surface conditioning disc.

DYNASTRIP™ TYPE 27 DISCS



Dia.	Grade	Center Hole	Mineral	Item #	Item #	Item #	Qty
4-1/2" (114 MM)	Extra Coarse	7/8"	SIC			78377	1
5" (127 MM)	Extra Coarse	7/8"	SIC			78378	1

— TOOL USED

↓
1.3 HP DEPRESSED
CENTER WHEEL GRINDER



DYNAFINISH™ CONVOLUTE WHEELS

Convolute Wheels are ideal for a wide range of deburring and finishing applications.

Wheels used on stainless steel, aluminum, titanium, carbon steel, plastic, composites, alloys and more!



Convolute Wheels are DIRECTIONAL, with an ARROW printed on label and stamped onto wheel.



DEBURRING WHEEL

- ↳ Silicon carbide or aluminum oxide non-woven nylon wheel, impregnated with resin.
- Ideal for removing light burrs, blending machine and belt marks, and applying final finishes.
- Also used for polishing molds, dies and surgical tools.

Diameter x Width	Center Hole	Grade	Max. RPM	Item #	Qty
6" (152 MM) X 1/2" (13 MM)	1" (25 mm)	7S Fine	6,000	78349	2
		8A Medium		78350	2
		8S Fine		78351	2
		9S Fine		78352	2
6" (152 MM) X 1" (25 MM)	1" (25 mm)	7S Fine	6,000	78353	2
		8A Medium		78354	2
		8S Fine		78355	2
		9S Fine		78356	2
8" (203 MM) X 1" (25 MM)	3" (76 mm)	7S Fine	4,500	78361	2
		8A Medium		78362	2
		8S Fine		78363	2
		9S Fine		78364	2
8" (203 MM) X 2" (51 MM)	3" (76 mm)	8A Medium	4,500	78366	1
		8S Fine		78367	1
		9S Fine		78368	1

DEBURRING WHEEL - TYPE "R"

- ↳ Silicon carbide non-woven nylon wheel, impregnated with more rigid resin for enhanced cutting action.
- Utilized for removing burrs, plus blending machine and belt marks.

Diameter x Width	Center Hole	Grade	Max. RPM	Item #	Qty
6" (152 MM) X 1/2" (13 MM)	1" (25 mm)	8S Fine	6,000	78369	2
				78370	2
8" (152 MM) X 1" (25 MM)	3" (76 mm)	8S Fine	4,500	78372	2

MULTI-FINISHING WHEEL

- ↳ Layers of silicon carbide non-woven nylon with soft, open web impregnated with resin.
- Ideal for achieving satin or cosmetic finishes, plus uniform or brushed finishes.
- Also great for removing weld discoloration, rust and general cleaning needs.

Diameter x Width	Center Hole	Grade	Max. RPM	Item #	Qty
6" (152 MM) X 1" (25 MM)	1" (25 mm)	2S Coarse	6,000	78374	2
		2S Medium		78137	2
6" (152 MM) X 2" (51 MM)	1" (25 mm)	2S Coarse	6,000	78390	1
		2S Medium		78136	1
8" (203 MM) X 1" (25 MM)	3" (76 mm)	2S Medium	4,500	78391	2
8" (203 MM) X 2" (51 MM)	3" (76 mm)	2S Medium	4,500	78393	1
		2S Coarse		78394	1

METAL FINISHING WHEEL

- ↳ Aluminum oxide non-woven nylon with medium density open web, impregnated with resin.
- Generates distinct finishes such as satin, cosmetic, brushed or antique.
- Blends abrasive scratches while achieving burr-free finish, acceptable for blending and polishing in one step!

Diameter x Width	Center Hole	Grade	Max. RPM	Item #	Qty
6" (152 MM) X 1" (25 MM)	1" (25 mm)	5A Medium	6,000	78395	2
				78396	1
8" (203 MM) X 1" (25 MM)	3" (76 mm)	5A Medium	4,500	78397	2

DYNAPREP™ SPECIALTIES

DynaPrep™ non-woven abrasive specialties compliment the wide range of DynaCut™ coated abrasive specialties broadening the range of applications Dynabrade services. Combined with the wide range of Dynabrade finishing and grinding tools, DynaPrep™ specialties provide multiple solutions for deburring, sanding, blending and finishing of a wide variety of materials, shapes and surfaces in markets like woodworking, metal fabrication, welding, marine, transportation, aerospace and wind energy.

Dynabrade's DynaBrite™ non-woven abrasive specialties include DynaBrite™ eyelet stars, spiral bands and DynaBrite™ flap wheels.

DYNAPREP™ EYELET STARS

DynaPrep™ surface conditioning eyelet stars are the ideal choice for polishing the internal diameter of pipe and tubing. The star shaped construction provides firmness and flexibility to completely clean and polish all surfaces without changing tolerances. DynaPrep™ eyelet stars are available in a variety of sizes and grades to meet a wide range of applications.



Dia.	Female Thread	Grade	Max. RPM	Item #	Qty	COMPATIBLE STAR MANDRELS	
						3" Length	7" Length
3/4"	3-48	Coarse	25,000	78703	50	93534	93533
		Medium		93919	50		
		Very Fine		93918	50		
1"	3-48	Coarse	25,000	78704	50	93534	93533
		Medium		78705	50		
		Very Fine		93922	50		
1-1/2"	8-32	Coarse	24,000	78706	50	93548	93532
		Medium		93925	50		
		Very Fine		93926	50		
2"	1/4-20	Coarse	24,000	78707	50	93550	93531
		Medium		93948	50		
		Very Fine		93939	50		
3"	1/4-20	Coarse	18,000	78708	50	93550	93531
		Medium		93960	50		
		Very Fine		93949	50		
4"	1/4-20	Coarse	18,000	78709	50	93550	93531
		Medium		93962	50		
		Very Fine		93961	50		

MANDRELS



DYNAPREP™ SPIRAL BANDS

DynaPrep™ SCM surface conditioning bands are good choices for light to heavy cleaning, deburring, blending, polishing and finishing on a variety of surfaces and materials.



	Dia.	Width	Grade	Item #	Qty
1" (25 MM)	1" (25 mm)		Coarse	90810	10
			Medium	90760	10
	1-1/2" (38 mm)		Coarse	90811	10
			Medium	90761	10
	2" (51 mm)		Coarse	90812	10
			Medium	90762	10
1-1/2" (38 MM)	1" (25 mm)		Coarse	90813	10
			Medium	90763	10
	1-1/2" (38 mm)		Coarse	90814	10
			Medium	90764	10
	2" (51 mm)		Medium	90765	10
2" (51 MM)	1" (25 mm)		Coarse	90816	10
			Medium	90766	10
	1-1/2" (38 mm)		Coarse	90817	10
			Medium	90767	10
	2" (51 mm)		Coarse	90818	10
			Medium	90768	10

	Dia.	Width	Grade	Item #	Qty
3" (76 MM)	1" (25 mm)		Coarse	90748	10
			Medium	90754	10
	2" (51 mm)		Coarse	90749	10
			Medium	90755	10
	3" (76 mm)		Coarse	90820	10
			Medium	90770	10
5" (127 MM)	1" (25 mm)		Coarse	90752	10
			Medium	90758	10
	2" (51 mm)		Coarse	90753	10
			Medium	90759	10
	3" (76 mm)		Coarse	90825	10
			Medium	90775	10



*See page 80-81 for full selection of slotted and expander wheels.

DYNAPREP™ FLAP WHEELS

DynaPrep™ non-woven flap wheels are an ideal choice for blending, deburring, cleaning and finishing applications in the welding, metal fabrication and polishing markets. Flap wheels conform to part shapes and contours and are excellent for flat surfaces. DynaPrep™ NWN flap wheels are designed to provide a consistent cut rate and superior finish. DynaPrep™ NWN flap wheels are stocked in the most common 1/4" shaft spindle mounted sizes for use on Dynabrade and other straight-line grinders.

Dia.	Width	Shaft Dia.	Max. RPM	Grade	Item #	Qty
2" (51 MM)	1" (25 mm)	1/4" (6 mm)	15,000	Coarse	78315	10
				Medium	78316	10
				Fine	78317	10
				Very Fine	78318	10
	2" (51 mm)	1/4" (6 mm)	15,000	Coarse	78763	10
				Medium	78764	10
				Fine	78765	10
				Very Fine	78766	10
3" (76 MM)	1" (25 mm)	1/4" (6 mm)	12,000	Coarse	78319	10
				Medium	78320	10
				Fine	78321	10
				Very Fine	78322	10
	2" (51 mm)	1/4" (6 mm)	12,000	Coarse	78767	10
				Medium	78768	10
				Fine	78769	10
				Very Fine	78770	10

TOOLS USED

STRAIGHT-LINE DIE GRINDER



DYNABRITE™ HAND PADS

DynaPrep™ general purpose non-woven hand pads can be utilized for cleaning and finishing on machinery or solid surfaces and natural stone. DynaPrep™ hand pads are also ideal for graining, denibbing, defuzzing and rust removal and can be used by hand or cut to fit in-line or jitterbug type Sanders.



W x L	Grade	Item #	Qty
6" (152 MM) X 9" (229 MM)	Very Fine	79447	60
		79448	20



DYNABRADE POWER BRUSHES

POWER BRUSHES

Dynabrade Power Brushes provide efficient solutions for Finishing, Cleaning, Stripping and Deburring on a wide variety of materials and shapes commonly encountered in numerous markets within Industrial Production as well as in the Welding and Fabrication market. Our standard brush line includes the most common shapes and types that are driven by Dynabrade power tools covering a broad range of applications.

POWER BRUSHES	114-122
↳ Wire Wheels	117
↳ Cup Brushes	118
↳ End Brushes	119-120
↳ Wheel Brushes	121-122

POWER BRUSHES

The Dynabrade line of power brushes combined with our wide variety of grinders provide high performance solutions for a broad array of applications. Mill scale removal, deburring, cleaning pipe threads and weld slag removal applications are quickly accomplished using power brushes. Removing flashing and excess rubber on molded components without damaging the substrate become predictable and efficient because power brushes will not load or become clogged when used on softer materials. Some wire brush shapes can be self-sharpening when the running direction is periodically reversed by switching the mounting position.

POWER BRUSH CHARACTERISTICS

SHAPES

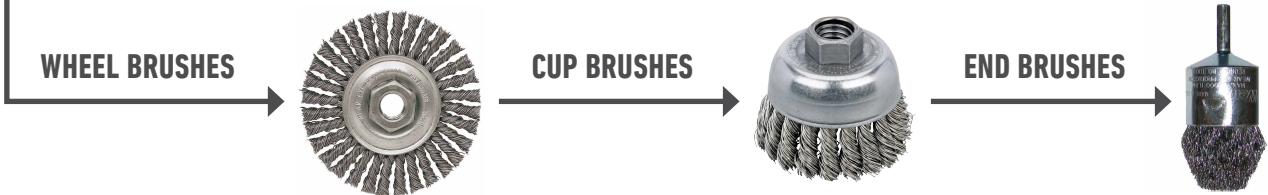

CARBON STEEL OR STAINLESS STEEL WIRE

Carbon steel wire brushes are the most durable for metal working and heavy-duty cleaning applications, while stainless steel brushes are recommended for brushing corrosion resistant materials or when the wheel is going to be used in a wet environment.

Speed, size, pressure and orientation of power brushes, are crucial to using power brushes safely and effectively. In most operations power brushes will provide the best performance at the highest speed and lightest pressure. The maximum safe rpm as stamped on every brush is not necessarily the optimum speed for any given operation. The rule of thumb is to run a minute per mile or approximately 5,000 surface feet per minute but never exceed the maximum safe free speed of the brush.

RECOMMENDED SPEEDS FOR BRUSHING APPLICATIONS

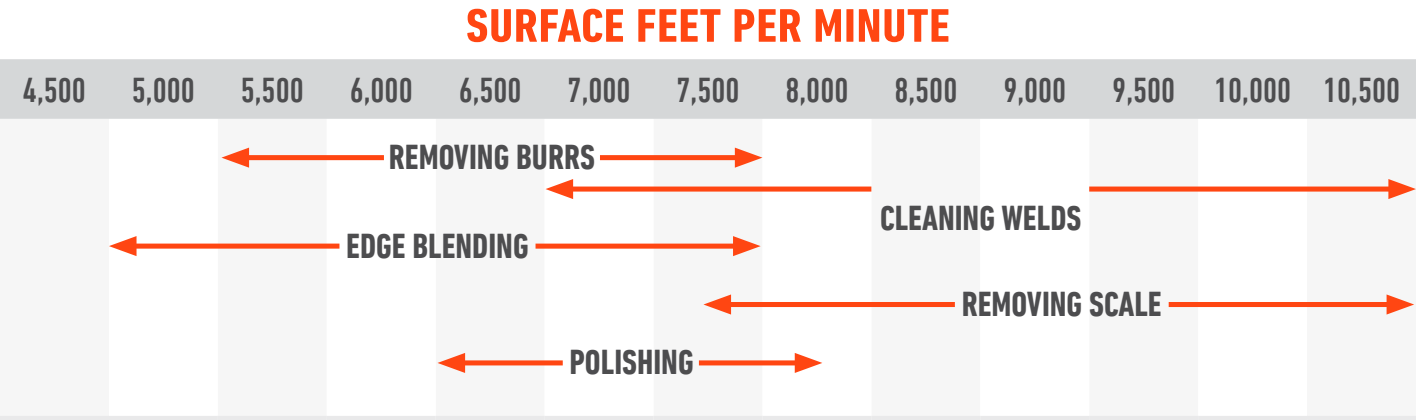

DYNABRADE POWER BRUSHES

Large diameter wire provides an aggressive brushing action but fatigues and breaks more readily; while small diameter wire is less aggressive, resists fatigue and provides a more flexible brushing action.

WIRE	COARSE	MEDIUM	FINE	VERY FINE	
Gauge #	25	30	33	38	47
Dia. Inches	.020	.014	.0118	.008	.006
Dia. mm	.51	.36	.30	.20	.15

CRIMPED

VS.

KNOT WIRE



Crimped wire allows individual filaments to support each other and is ideal for light to medium duty applications, especially on parts that could be damaged by the impact of a knot brush. Crimped wire brushes are used on the broadest range of applications.



Knot wire is composed of straight filaments that are twisted together to form a single unit like a wire rope. These power brushes are best suited for more aggressive applications where the part requires high impact action to remove large burrs, and heavy surface contamination like rust, mill scale, paint and oxides.

2 TYPES OF CONFIGURATIONS



1 STANDARD TWIST

- Standard twist wire provides some flexibility for use on irregular shapes with sharp wire tips that are aggressive from the start.

2 STRINGER BEAD TWIST

- Stringer Bead twist wire is best for applications that require high impact action like weld cleaning. The sharp wire tips also make this wire very aggressive from the start.

SURFACE SPEED BY DIAMETER AND RPM

RPM	DIAMETER (INCHES)		
	2"	3"	4"
1,000	523	785	1047
1,500	785	1178	1570
1,750	916	1374	1832
2,500	1308	1963	2617
3,000	1570	2355	3140
3,450	1806	2708	3611
4,000	2093	3140	4187
6,000	3140	4710	6280
10,000	5233	7850	10467
15,000	7850	11775	15700
20,000	10467	15700	20933

PRESSURE

- Let the sharp wire tips of the brush do the work. Excessive pressure causes the filaments to over-bend and build up heat which can result in early filament breakage, dulling of the wire tips and reduced brush life.

ORIENTATION

- Stringer Bead twist wire is best for applications that require high impact action like weld cleaning. The sharp wire tips also make this wire very aggressive from the start.

TIME

- To get any power brushing job done in the shortest amount of time it is always best to choose the most appropriate product configuration and power tool.

POWER BRUSHES

SELECTING THE RIGHT BRUSH FOR THE JOB BY TOOL TYPE

TOOL TYPE	KNOT WHEELS	CRIMPED CUPS	KNOT CUPS	CRIMPED STEM-MTD. WHEELS	KNOT STEM-MTD. WHEELS	CRIMPED STEM-MTD. END	KNOT STEM-MTD. END
Right Angle Grinder	•	•	•				
Straight Grinder				•	•	•	•
Die Grinder	•			•	•	•	•

BY WIRE SIZE

To get the best total performance with wire brushes always use the finest wire diameter or size that will allow you to complete the job without requiring excessive pressure on the brush face. Let the sharp wire ends do the work.

POWER BRUSHES STANDARD TWIST KNOT WIRE WHEELS

Standard Twist threaded-nut knot wire wheels are primarily intended to be used on right-angle grinders. These aggressive wire wheels are available in heat treated steel and Type 302 stainless steel, and provide high impact action for heavy duty applications like coating removal, weld preparation, cleaning corrosion and removing burrs from large pieces after cutting.

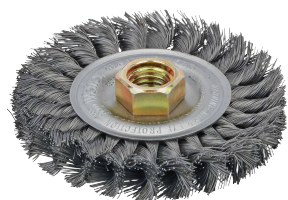

Dia.	Wire Size	Arbor Hole	Max. Operating Speed	Material	Item #	Pkg. Qty
4" (102 MM)	.014	5/8"-11 UNC	20,000 RPM	Steel	78800	1
				Stainless Steel	78801	1
	.020	3/8"-24 UNF		Steel	78804	1
	.020	5/8"-11 UNC		Steel	78805	1

TOOL USED



POWER BRUSHES STRINGER BEAD TWIST WIRE WHEELS

Stringer Bead Twist threaded-nut knot wire wheels are the standard for high performance weld cleaning and are best suited for cleaning filler and cap passes and other surface prep and cleaning applications prior to welding. Each knot has the same wire count, ensuring perfect balance and minimum vibration.



Dia.	Wire Size	Arbor Hole	Max. Operating Speed	Material	Item #	Pkg. Qty
4" (102 MM)	.020	3/8"-24 UNC	20,000 RPM	Stainless Steel	78808	1
		5/8"-11 UNC		Steel	78809	1
		5/8"-11 UNC		Stainless Steel	78810	1
		3/8"-24 UNF		Steel	78884	1

TOOL USED



POWER BRUSHES KNOT WIRE CUP BRUSH

Knot wire cup brushes are used on right angle grinders for brushing large surface areas more efficiently than a wheel brush. The threaded nut is designed for smooth and efficient operation to make quick work doing large jobs. Ideal for heavy duty cleaning, removing slag from the edges of plasma cutting and flame cut parts, removing paint and coatings, cleaning rust scale and corrosion, deburring and weld prep applications.



Dia.	Wire Size	Arbor Hole	Max. Operating Speed	Material	Item #	Pkg. Qty
2-3/4" (70 MM)	.014	5/8"-11 UNC	14,000 RPM	Steel	78819	1
				Stainless Steel	78886	1
	3/8"-24 UNF	Stainless Steel		78885	1	
		Stainless Steel		78823	1	
	.020	5/8"-11 UNC		Steel	78822	1
				Stainless Steel	78823	1



POWER BRUSHES CRIMPED WIRE CUP BRUSHES

Crimped wire cup brushes provide very flexible brushing for light to medium cleaning of large surfaces, removal of rust and other coatings. They can also be used to roughen surfaces as well as for light deburring.



Dia.	Wire Size	Arbor Hole	Max. Operating Speed	Material	Item #	Pkg. Qty
3" (76 MM)	.014	5/8"-11 UNC	14,000 RPM	Steel	78814	1
				Steel (Light Duty)	78782	1



POWER BRUSHES STEM MOUNTED END BRUSHES

Dynacut™ Wire End Brushes are primarily designed for use on high speed die grinders for brushing and cleaning smaller surfaces and recessed areas. They can also be used on portable and stationary drills. Dynacut end brushes integrate a 1/4" steel stem for quick mounting and safe operation at high speeds. Wire end brushes are offered in a variety of configurations including knot and crimped wire with sold ends, and crimped wire with controlled flare ends. Dynacut™ wire end brushes are manufactured to the highest quality standards for smooth performance, long life, and are available in heat treated steel and Type 302 stainless steel. Applications include I.D. cleaning, deburring internal edges and cross holes intersections, removing die flash and excess molded materials.



POWER BRUSHES CRIMPED WIRE END BRUSHES-SOLID END

For light-duty, general purpose applications like cleaning and polishing dies and molds plus removing rubber/plastic flash, rust and coatings.



Dia.	Wire Size	Trim Length	Max. Operating Speed	Material	Item #	Pkg. Qty
1/2" (13 MM)	.006	7/8"	25,000 RPM	Stainless Steel	78783	1
				Steel	78824	1
	.014	7/8"		Stainless Steel	78825	1
				Steel	78826	1
	.020	7/8"		Stainless Steel	78827	1
				Steel	78828	1
3/4" (19 MM)	.006	7/8"	22,000 RPM	Steel	78829	1
				Stainless Steel	78830	1
	.014	7/8"		Steel	78831	1
				Stainless Steel	78832	1
	.020	7/8"		Steel	78833	1
				Stainless Steel	78834	1
1" (25 MM)	.006	1"	22,000 RPM	Stainless Steel	78835	1
				Stainless Steel	78836	1
				Stainless Steel	78837	1
	.014	1"		Stainless Steel	78837	1
				Steel	78838	1
.020	1-1/8"	Steel	78838	1		

TOOLS USED



STRAIGHT-LINE DIE GRINDER

RIGHT ANGLE DIE GRINDER

POWER BRUSHES CRIMPED WIRE END BRUSHES-CONTROLLED FLARE END

Controlled Flare end brushes offer increased durability when cleaning right angles, corners and fillet welds and are also good for removing weld splatter, flash and scale.



Dia.	Wire Size	Trim Length	Max. Operating Speed	Material	Item #	Pkg. Qty
1/2" (13 MM)	.0104	7/8"	25,000 RPM	Steel	78839	1
				Stainless Steel	78840	1
				Steel	78841	1
				Stainless Steel	78842	1
	.020	7/8"	Steel	78843	1	
3/4" (19 MM)	.0104	7/8"	22,000 RPM	Steel	78844	1
				Stainless Steel	78845	1
	.014	7/8"		Steel	78846	1
				.020	7/8"	Steel
1" (25 MM)	.006	1"	22,000 RPM	Steel	78848	1
				Stainless Steel	78849	1
	.014	1"		Steel	78850	1
				.020	1-1/8"	Steel

TOOLS USED

STRAIGHT-LINE
DIE GRINDER



RIGHT ANGLE
DIE GRINDER



POWER BRUSHES KNOT WIRE END BRUSHES-HOLLOW END

The aggressive construction of knot wire end brushes provide an aggressive, high-impact action for severe applications like removing mill scale and slag, or cleaning pipe ID's.



Dia.	Wire Size	Trim Length	Max. Operating Speed	Material	Item #	Pkg. Qty
3/4" (19 MM)	.014	7/8"	20,000 RPM	Steel	78822	1
				Stainless Steel	78853	1
	.020			Steel	78854	1
1-1/8" (29 MM)	.014	7/8"	20,000 RPM	Steel	78855	1
				Stainless Steel	78856	1
	.020	7/8"	20,000 RPM	Steel	78857	1
				Stainless Steel	78858	1

TOOL USED

STAINLESS STEEL
STRAIGHT-LINE
DIE GRINDER



POWER BRUSHES STEM MOUNTED RADIAL WHEEL BRUSHES

DynaCut™ stem mounted radial wheel brushes are permanently mounted to a 1/4" steel stem or shank and are intended for use on high speed die grinders but can also be mounted on pneumatic and electric drills. The speed and power of portable drills however will limit the effectiveness of these brushes. Dynacut™ stem mounted radial wheel brushes feature solid ring construction and are available in crimped wire and knotted wire in heat treated steel and Type 302 stainless steel. Stem mounted radial wheel brushes are effective for cleaning and finishing ID and recessed areas, removing paint and coatings, cleaning threads and light deburring.

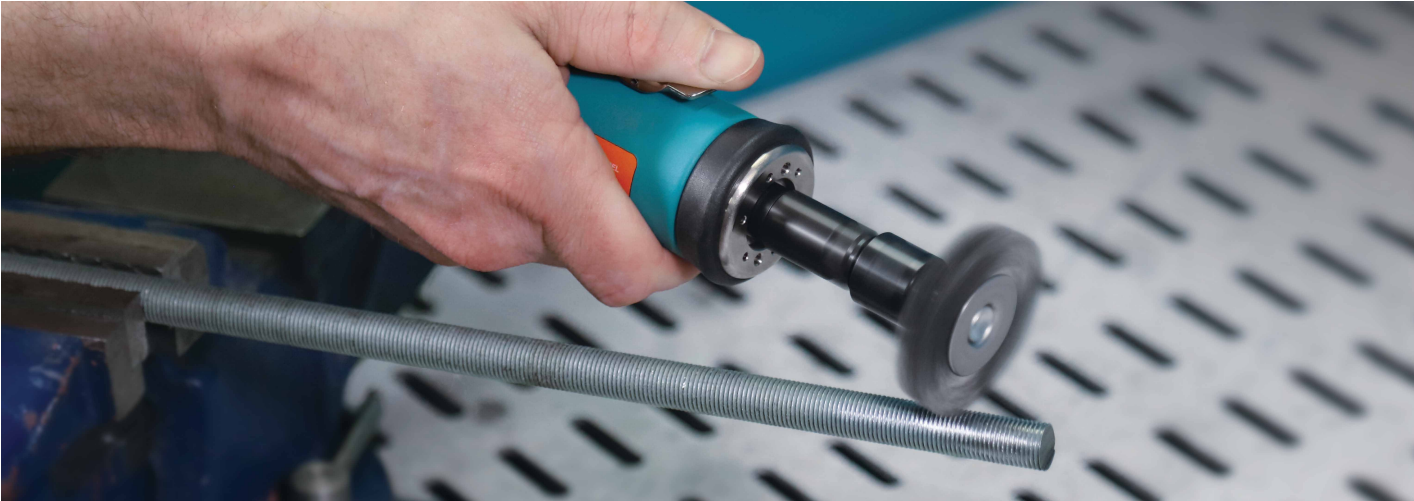

POWER BRUSHES CRIMPED WIRE RADIAL WHEEL BRUSHES

Dynacut™ crimped wire radial wheels feature a short trim length for more aggressive brushing action.

Dia.	Wire Size	Trim Length	Max. Operating Speed	Material	Item #	Pkg. Qty	TOOLS USED ↓ STRAIGHT-LINE DIE GRINDER
1-1/2" (38 MM)	.006	3/8"	20,000 RPM	Steel	78859	1	
	.0118			Steel	78861	1	
2" (51 MM)	.006	7/16"	20,000 RPM	Steel	78860	1	
	.0118			Steel	78861	1	
2-1/2" (64 MM)	.008	9/16"	20,000 RPM	Steel	78862	1	
	.0188			Steel	78863	1	
3" (76 MM)	.008	13/16"	20,000 RPM	Steel	78864	1	
	.0118			Steel	78865	1	
	.014			Stainless Steel	78866	1	



POWER BRUSHES CRIMPED WIRE CONCAVE RADIAL WHEEL BRUSHES

For cleaning and deburring using a die grinder or on a drill press, the concave brush shape is efficient for use in corners.



Dia.	Wire Size	Trim Length	Max. Operating Speed	Material	Item #	Pkg. Qty
1-1/2" (38 MM)	.006	3/8"	20,000 RPM	Stainless Steel	78867	1
	.0118			Steel	78868	1
2" (51 MM)	.008	1/2"	20,000 RPM	Steel	78869	1
	.014			Steel	78870	1
	.014			Stainless Steel	78871	1
2-1/2" (64 MM)	.014	5/8"	20,000 RPM	Steel	78872	1
3" (76 MM)	.006	15/16"	20,000 RPM	Stainless Steel	78873	1
	.014			Steel	78874	1
	.014			Stainless Steel	78875	1

TOOLS USED

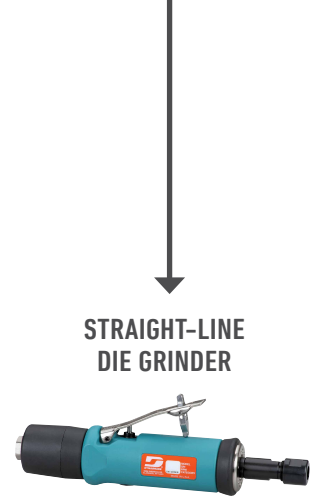

STRAIGHT-LINE
DIE GRINDER

POWER BRUSHES KNOTTED WIRE RADIAL WHEEL BRUSHES

The Knot wire construction provides aggressive high impact action for severe applications.



Dia.	Wire Size	Trim Length	Max. Operating Speed	Material	Item #	Pkg. Qty
3-1/4" (83 MM)	.0118	3/8"	25,000 RPM	Steel	78876	1
	.014			Steel	78877	1
				Stainless Steel	78878	1
	.020			Steel	78879	1
4" (102 MM)	.014	1/2"	20,000 RPM	Steel	78880	1
	.020			Steel	78881	1

TOOLS USED

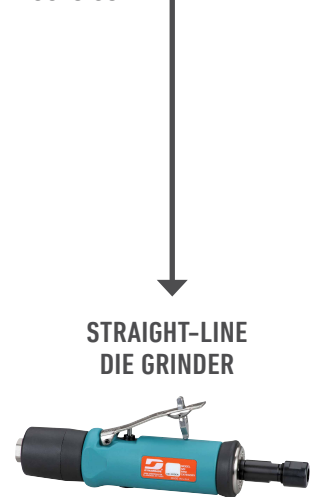

STRAIGHT-LINE
DIE GRINDER

DYNABURR™ CARBIDE BURRS

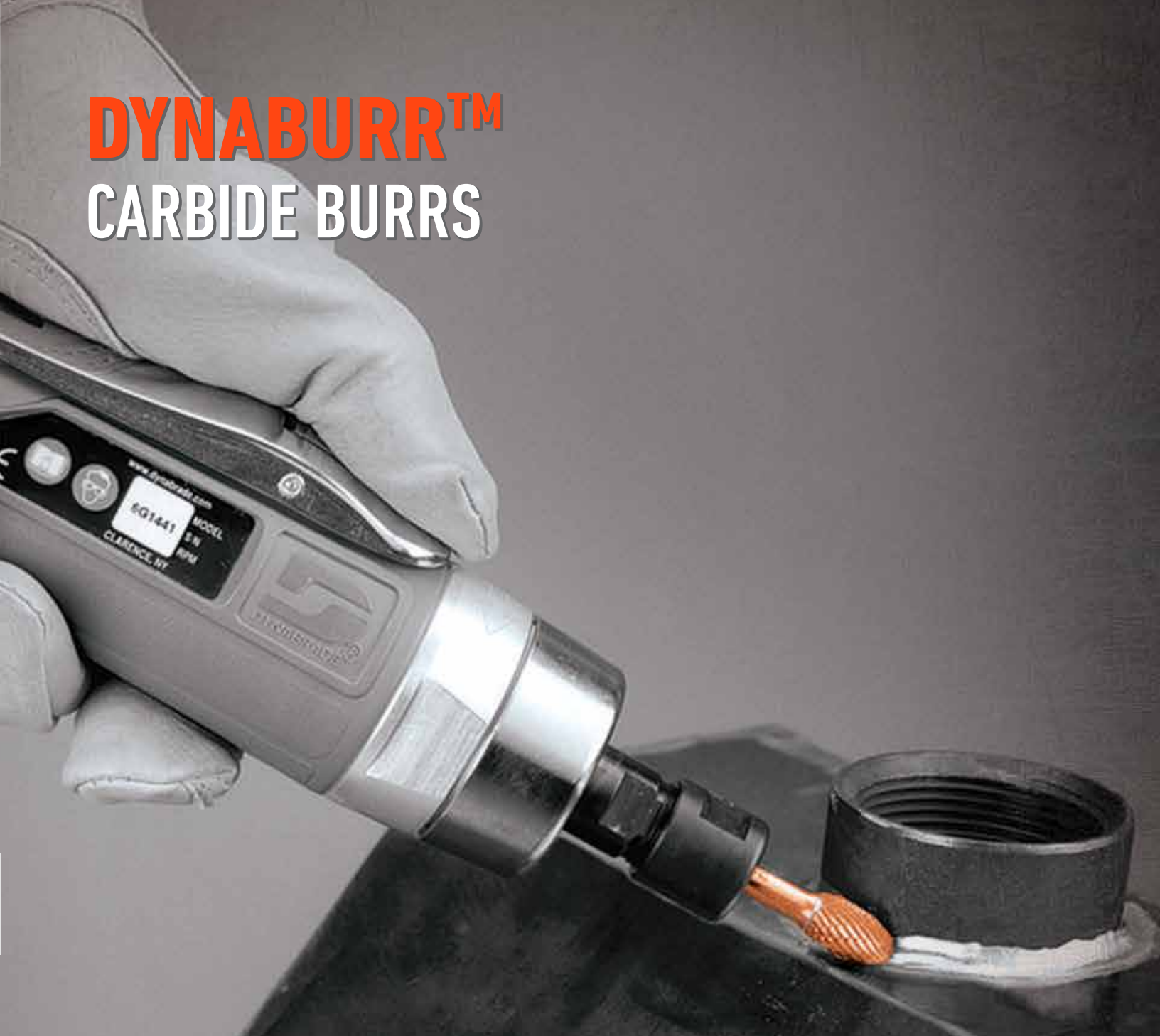

CARBIDE BURRS

Dynaburr™ Carbide Burrs are manufactured in compliance with the highest standards. Our stocked line of products is available in the most common shapes in 1/8", 3 mm, 1/4" and 6 mm shank including pre-assorted kits. Dynaburrs provide good performance and a wide range of applications solutions for rapidly removing material, deburring, removing flashing and parting lines and finishing.

CARBIDE BURRS	123-126
↳ Dynaburr Kits	126

DYNABURR™ CARBIDE BURRS

Carbide rotary burrs are used for cutting, shaping, grinding and for the removal of sharp edges, burrs and excess material.

Tungsten carbide burrs are commonly used on a variety of materials including steel, stainless steel, aluminum, cast iron, exotic alloys, precious metals, ceramics and composites, non-ferrous metals and wood.

The Key markets for DynaBurr Tungsten Carbide Burrs include Transportation – Aerospace, Rail, Marine and Automotive; Metalworking and Metal Fabrication – Welding, Tool and Die, Castings and Foundries; Energy – Oil and Gas, Wind Turbine.



Dynaburr™ tungsten carbide burrs are used on Dynabrade pencil grinders and die grinders. All DynaBurr's are double cut style and are ideal for medium to light stock removal, chamfering, deburring, weld removal and blending, creating radii, precise finishing, polishing and for removal of parting lines and flash. DynaBurr tungsten carbide burrs provide significantly longer life than high speed steel burrs.

Available in 3 mm and 6 mm metric shanks and 1/8" and 1/4" shank sizes.

DynaBurr™ carbide burrs are offered in the most common shapes including:

Cylinder, Radius End Cylinder, Ball, Cone, Inverted Cone, Tree and Flame to cover a broad range of applications and surface profiles.

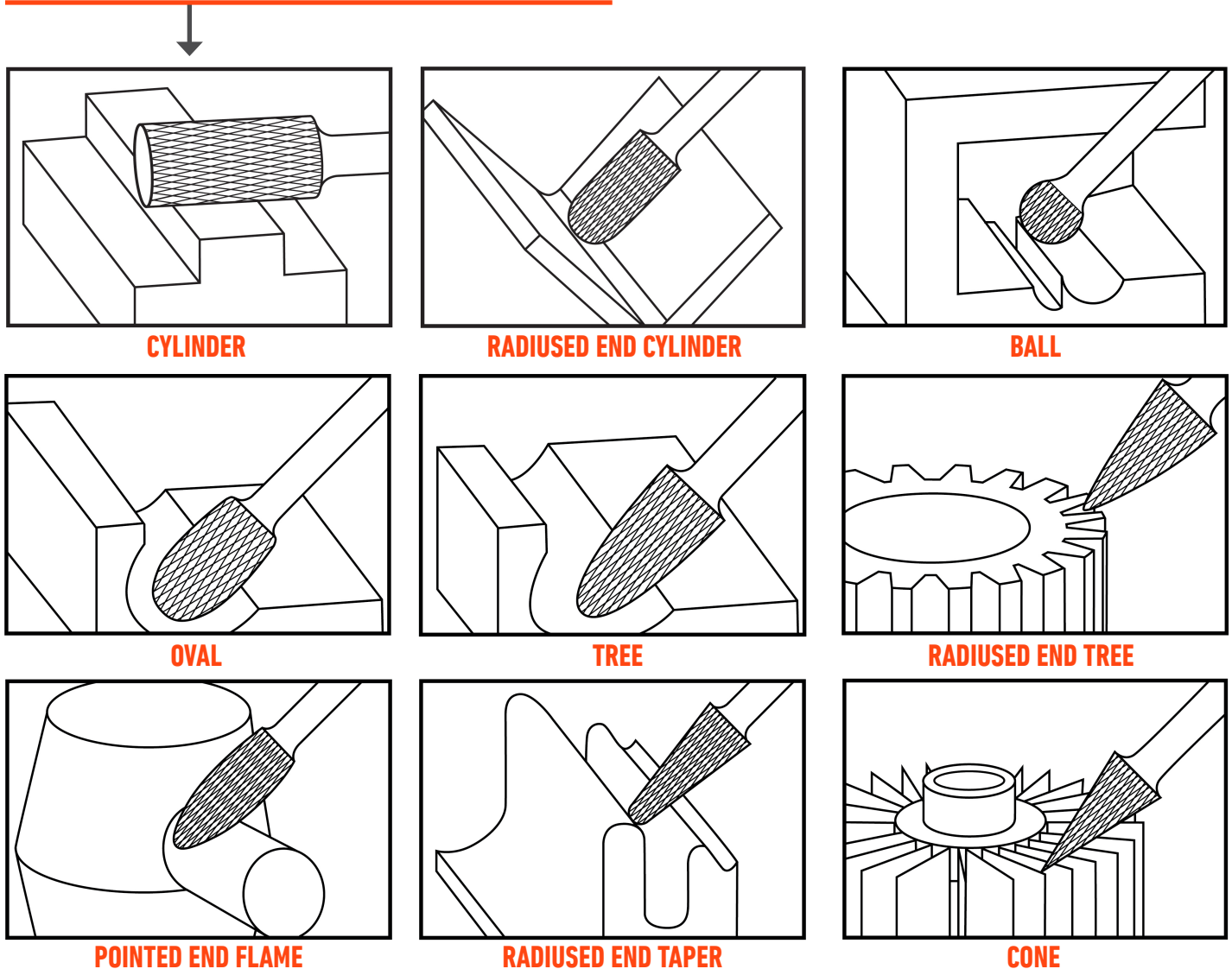

FOR MAXIMIZING PERFORMANCE SAFETY

- 1 Apply light pressure and let the burr do the work.
- 2 Keep the carbide burr moving along the surface to avoid gouging and digging causing a rough surface.
- 3 Try to end on an up stroke to generate smoother finishes.
- 4 Ensure burr is inserted into the collet and clamped down tightly.
- 5 Work on the highest material first and use light pressure while keeping the burr moving.
- 6 Make sure the work piece or surface is secure.
- 7 Avoid jamming burr into the work piece.

MATERIALS	RECOMMENDED OPERATING SPEEDS									
Exotic Alloys	1,400-1,800 SFPM 420-540 m/min									
Hardened Steels 45HRc+	1,600-2,200 SFPM 480-660 m/min									
Non-Hardened Steels 45HRc-	2,000-2,600 SFPM 600-780 m/min									
Non-Ferrous Light Metals	2,600-3,000 SFPM 780-900 m/min									
Plastics, Hard Rubber, Fiberglass and Composites	2,400-3,000 SFPM 720-900 m/min									
BURR DIAMETER	RPM									
3-1/2" (2.5 mm)	45,000	53,000	60,000	66,000	73,000	79,000	86,000	92,500	100,000	
1/8" (3 mm)	45,000	53,000	60,000	66,000	73,000	79,000	86,000	92,500	100,000	
1/4" (6 mm)	26,000	30,000	34,000	37,500	41,500	45,000	49,000	52,500	55,000	
3/8" (9 mm)	17,500	20,000	22,500	25,000	27,500	30,000	32,500	35,000	37,500	

DIE GRINDER COLLETS & INSERTS

TERMINOLOGY

- COLLET: Device used to hold carbide burrs, rotary files, mounted points and wheels, etc.
- BODY: The part of the collet that secures to the spindle of the tool and accepts the inserts.
- CAP: Secures collet body and retains insert.
- INSERT: The collapsible portion of the collet that retains the shank of the inserted tool.

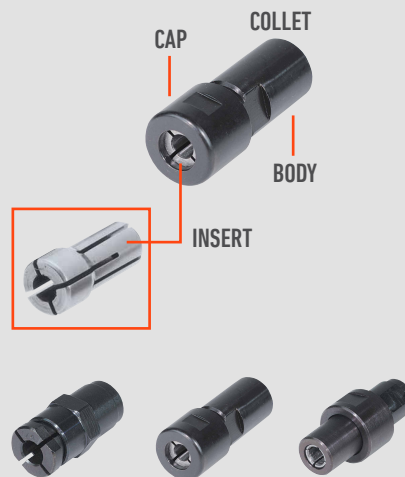

COLLET ASSEMBLY TYPES

- TWO-PIECE: Insert threads into body.
- THREE-PIECE: Insert slips into body; cap threads to body, retaining the insert.
- FOUR-PIECE: Insert slips into body; cap slips over body; nut retains cap and insert.
- INTEGRATED: Collet body is integrated into tool.

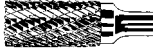

DYNABURR™ CARBIDE BURRS CONTINUED

DynaBurr™ carbide burrs are used with Dynabrade pencil grinders and die grinders. Utilized for rapid material removal, precise finishing, deburring, polishing, and removal of parting lines and flash. Carbide burrs provide longer life than high-speed steel burrs.

Shape	1/8" & 3 MM DYNABURRS, DOUBLE CUT STYLE					1/4" & 6 MM DYNABURRS, DOUBLE CUT STYLE					
	Tool Style	Cutter Dia	Flute Length	Shaft Size	Item #	Tool Style	Cutter Dia	Flute Length	Shaft Size	Item #	Pkg. Qty
 Cylinder	SA-42	3/32"	7/16"	1/8"	93338	SA-1	1/4"	5/8"	1/4"	93330	1
		2.5 mm	11 mm	3 mm	93368		6 mm	16 mm	6 mm	93360	1
	SA-43	1/8"	9/16"	1/8"	93339	SA-3	3/8"	3/4"	1/4"	93331	1
		3 mm	14 mm	3 mm	93369		9 mm	19 mm	6 mm	93361	1
 Cylinder Radiused End	SC-41	3/32"	7/16"	1/8"	93340	N/A	N/A	N/A	N/A	N/A	1
		2.5 mm	11 mm	3 mm	93370		N/A	N/A	N/A	N/A	N/A
	SC-42	1/8"	9/16"	1/8"	93341	SC-1	1/4"	5/8"	1/4"	93332	1
		3 mm	14 mm	3 mm	93371		6 mm	16 mm	6 mm	93362	1
	N/A	N/A	N/A	N/A	N/A	SC-3	3/8"	3/4"	1/4"	93333	1
		N/A	N/A	N/A	N/A		9 mm	19 mm	6 mm	93363	1
Ball	N/A	N/A	N/A	N/A	N/A	SD-3	3/8"	5/16"	1/4"	93334	1
		N/A	N/A	N/A	N/A		9 mm	8 mm	6 mm	93364	1
Ball Radiused End	SD-42	1/8"	1/8"	1/8"	93342	N/A	N/A	N/A	N/A	N/A	1
		3 mm	3 mm	3 mm	93372		N/A	N/A	N/A	N/A	1
Oval	SE-41	1/8"	7/32"	1/8"	93343	SE-3	3/8"	5/8"	1/4"	93335	1
		3 mm	5.5 mm	3 mm	93373		9 mm	16 mm	6 mm	93365	1
Tree	SF-42	1/8"	1/2"	1/8"	93344	N/A	N/A	N/A	N/A	N/A	1
		3 mm	13 mm	3 mm	93374		N/A	N/A	N/A	N/A	1
Tree Radiused End	SG-44	1/8"	1/2"	1/8"	93345	SF-3	3/8"	3/4"	1/4"	93336	1
		3 mm	13 mm	3 mm	93375		9 mm	19 mm	6 mm	93366	1
Flame Pointed End	SH-41	1/8"	1/4"	1/8"	93346	N/A	N/A	N/A	N/A	N/A	1
		3 mm	6 mm	3 mm	93376		N/A	N/A	N/A	N/A	1
Taper Radiused End	SL-42	1/8"	1/2"	1/8"	93347	SL-3	3/8"	1-1/16"	1/4"	93337	1
		3 mm	13 mm	3 mm	93377		9 mm	27 mm	6 mm	93367	1
14° Cone End	SM-42	1/8"	7/16"	1/8"	93348	N/A	N/A	N/A	N/A	N/A	1
		3 mm	11 mm	3 mm	93378		N/A	N/A	N/A	N/A	1
10° Inverted Cone	SN-42	1/8"	3/16"	1/8"	93349	N/A	N/A	N/A	N/A	N/A	1
		-	-	-	-		N/A	N/A	N/A	N/A	1

N/A - Not Available.

DYNABURR™ KITS

Kits (1/8", 3 mm, 1/4" or 6 mm) include one Carbide Burr of each shape, as shown above. Packaged in high-quality wooden case.

Burr Shaft Size	Item #	Burr Qty
1/8"	93351	12
3 mm	93381	12
1/4"	93350	8
6 mm	93380	8



DYNACUT™

BONDED ABRASIVES

BONDED ABRASIVES

The Dynabrade bonded abrasive line offers a range of solutions for cutting, grinding and finishing in foundry/forge shops, tool and die, welding and metal fabrication, steel mills and ship yards. The bonded abrasive line consists of Type 41 cut off wheels, Type 27 grinding wheels, Type 1 snagging wheels and a completely new line of mounted points.

BONDED ABRASIVES	127-131
↳ Mounted Points	129-130
↳ Cut-Off Wheels	131
↳ Depressed Center Wheels	131
↳ Snagging Wheels	131

DYNACUT™ BONDED ABRASIVES MOUNTED POINTS, TYPE 27, 41 & 1 WHEELS

DynaCut™ mounted points are very small bonded abrasive wheels that come in variety of shapes including ball, point, cone, cylinder or bullet. They are mounted on 1/8" or 1/4" mandrels while cones and plugs have a threaded bore for use with Dynabrade and other pencil grinders, portable die grinders and cone/plug grinders. Available in aluminum oxide, pink aluminum oxide, zirconia alumina and ceramic abrasives.

When choosing the correct mounted point consider the OD required in the application, the rotary speed of the tool, the shank diameter (for mounted points) and the bore thread and ID (for cones and plugs).

Mounted points are used in many different applications and industries including aerospace, tool and die, construction, metal fabrication, welding, automotive, cutlery, mold shops, stainless steel equipment and foundries. Some mounted points are used for wet grinding, dry grinding, heavy to light material removal, blending, deburring and finishing and others for fine polishing or honing.

DynaCut™ mounted points are available in four product performance tiers in vitrified and resin bond formulations and a wide selection of A, B and W shapes.

1 DYNACUT™ CERAMIC VITRIFIED BOND

The BEST choice for volume production operations where form holding and finer finishes are required.

FEATURES

- 1 Features premium ceramic alumina grain and bond technology

BENEFITS

Reduces loading and heat build up, provides longer life and higher metal removal and is versatile and optimized for low, medium and high force applications.



2 DYNACUT™ ZIRCONIA ALUMINA RESIN BOND

The BETTER choice for fast stock removal and longer life than ordinary aluminum oxide mounted points.

FEATURES

- 1 Features Zirconia alumina/aluminum oxide blend
- 2 Aggressive free cutting action
- 3 Has a uniquely formulated organic resin bond system

BENEFITS

For up to a 35% faster cut rate.
Cleans more parts in less time.
Provides up to 2 times greater life with reduced vibration and chatter.



3 DYNACUT™ PREMIUM ALUMINUM OXIDE VITRIFIED BOND

The GOOD choice for small to high volume operations.

FEATURES

- 1 Features a premium fast cutting pink aluminum oxide abrasives and vitrified bond

BENEFITS

For longer life and better form holding than regular competitive aluminum oxide mounted points.

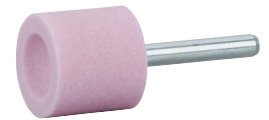

4 DYNACUT™ ALUMINUM OXIDE VITRIFIED BOND

The VALUE choice for general purpose small job shop operations.

FEATURES

- 1 Features high-performing aluminum oxide abrasive and vitrified bond

BENEFITS

For cool cutting action and less burn. Good choice when the initial price point is the main purchasing objective.

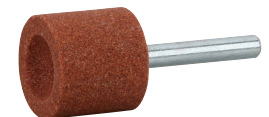

DYNACUT™ BONDED ABRASIVES MOUNTED POINTS

DYNACUT™ COTTON FIBER ALUMINUM OXIDE RESIN BOND

The GOOD choice for blending and polishing.

5

FEATURES

- 1 Features a compressed cotton fiber abrasive grain and bond matrix

BENEFITS

Can deburr and finish in one step. Control metal removal & deliver smooth chatter free operation while generating superior finishes on stainless steel and aluminum. Additionally, these burrs resist loading on softer materials like aluminum and brass.

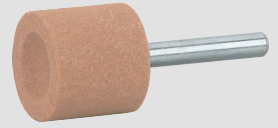

DYNACUT™ COTTON FIBER



Shape	Size (D x T)	Spindle Dia.	Max. RPM	Type	Item #	Pkg. Qty
B52	3/8" x 3/4"	1/8"	45,370	MS	78535	10
W164	1/4" x 3/4"		45,900		78775	10
W176	3/8" x 1-1/2"		47,880		78776	10
W185	1/2" x 1/2"	1/4"	44,470		78777	10

Type KEY

- MS-Fine Deburring
- MH-Polishing

Shape	Size (D x T)	Spindle Dia.	Max. RPM	Type	Item #	Pkg. Qty
B52	3/8" x 3/4"	1/8"	45,370	MH	78778	10
W164	1/4" x 3/4"		45,900		78779	10
W176	3/8" x 1-1/2"		47,880		78780	10
W185	1/2" x 1/2"	1/4"	44,470		78781	10

NOTE: MAXIMUM RPM AND OVERHANG

The maximum RPM for spindle mounted points is valid up to a maximum overhang of 1/2"

OVERHANG: the distance between the grinder collet/chuck and the abrasive on the spindle.

The larger the overhang, the lower the maximum safe operating speed. See package insert for other overhangs.

MEASUREMENT GUIDE

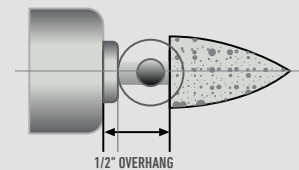

TECH TIPS

For best mounted point performance, run the mounted point at the maximum allowable speed according to ANSI B7.1. Refer to the speed chart in each package for proper operating speeds.

- "A" shapes are used for medium to heavy blending.
- "B" shapes are used for light deburring and finishing/polishing.
- "W" shapes are used for offhand and precision grinding of medium to heavy stock.
- 36 grit and coarser are best for rough grinding.
- 60 grit and finer are best for grinding narrow surfaces and for imparting fine finishes.



It is the user's responsibility to refer to and comply with ANSI B7.1

BONDED ABRASIVES MOUNTED POINTS

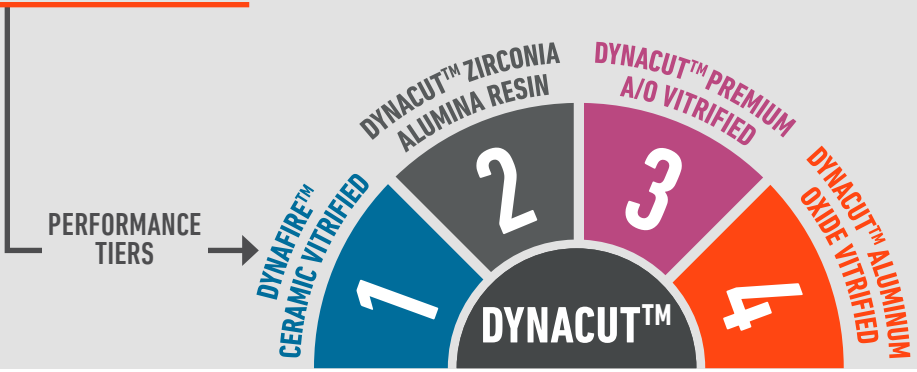

BONDED GRIT/GRADE KEY

	100 RVS3
	24 UBXR 1
	80 QVBE
	60 PVM

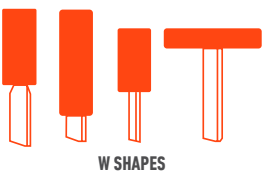
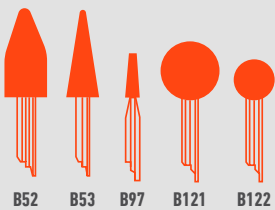
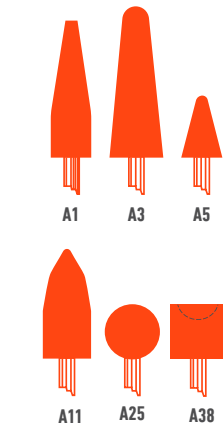

Shape	Size (D x T)	Spindle Dia.	Max. RPM	Item #	Item #	Item #	Item #	Pkg. Qty	
B52	3/8" x 3/4"	1/8"	45,370	-	-	78724	78709	5	
B53	5/16" x 5/8"		60,000	78739	-	78725	78710	5	
B122	3/8" x 3/8" Ball		61,650	78740	-	78726	78711	5	
W154	3/16" x 1/2"		70,500	78741	-	78727	78712	5	
B97	1/8" x 3/8"		105,000	78742	-	78728	78713	5	
W164	1/4" x 3/4"		45,900	78743	-	78729	78714	5	
W215	1" x 1/8" Hub		38,200	78744	-	78730	78715	5	
A3	1" x 2-3/4"		1/4"	16,100	78745	78754	78731	78716	5
W189	1/2" x 2"			24,000	-	78755	-	-	5
W208	3/4" x 2"			19,100	-	78756	-	-	5
A1	3/4" x 2-1/2"	19,800		78746	-	78732	78717	5	
A11	7/8" x 2"	19,860		78747	78753	78733	78718	5	
A5	3/4" x 1-1/8"	45,000		78748	78760	78734	78719	5	
W207	3/4" x 1-1/2"	24,000		-	78761	-	-	5	
B121	1/2" x 1/2"	45,370		78749	-	78735	78720	5	
A25	1" x 1" Ball	35,620		78750	-	78736	78721	5	
A38	1" x 1"	34,500		78751	-	78737	78722	5	
W220	1" x 1"	34,500	-	78762	-	-	5		
W221	1" x 1-1/2"	19,120	-	78758	-	-	5		
W197	5/8" x 2"	21,000	-	78759	-	-	5		
W222	1" x 2"	18,750	-	78757	-	-	5		
W242	2" x 1"	19,100	78752	-	78738	78723	5		



BONDED ABRASIVES CUT-OFF WHEELS, DEPRESSED CENTER WHEELS, SNAGGING WHEELS

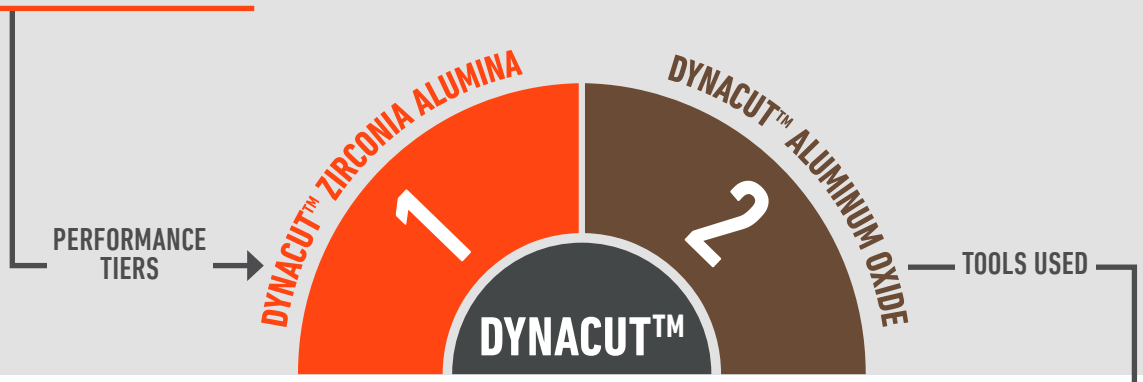

TYPE 41 REINFORCED CUT-OFF WHEELS

Used for a variety of applications, such as cutting sheet metal, pipe, drill bits, steel bar, tubing and metallurgical sectioning. Utilized in foundry/forge shops for gate/riser removal and cutting forgings. Also used for metal plate dimensioning.



Dia.	Thickness	Center Hole	Max. RPM	Mineral	Item #	Item #	Pkg. Qty
3"	.035"	3/8"	25,400	Z/A	79356	-	10
				A/O	-	79357	10
4"	.035"	3/8"	19,100	Z/A	79388	-	10
				A/O	-	79389	10



CUT-OFF WHEEL TOOL

TYPE 27 DEPRESSED CENTER WHEELS

Used for weld grinding and all metal fabrication applications.



Dia.	Center Hole	Max. RPM	Mineral	Item #	Item #	Pkg. Qty
2"	3/8"	27,120	A/O	-	90999	10
4-1/2"	7/8"	13,500	Z/A	79390	-	10
			A/O	-	79391	10
5"	7/8"	13,500	Z/A	79392	-	10
			A/O	-	79393	10



5" DIA. RIGHT ANGLE DISC SANDER

TYPE 1 SNAGGING WHEELS

Ideal for cleaning castings, smoothing seam welds and rough beveling. Used in foundries, welding shops, steel mills and shipyards.



Dia.	Center Hole	Thickness	Max. RPM	Mineral	Item #	Pkg. Qty
3"	3/8"	1/2"	18,080	A/O	79394	10
4"	3/8"	1/4"	15,280		79395	10

3" DIA. STRAIGHT-LINE TYPE 1 EXTENSION WHEEL GRINDER



POLISHING BELTS SYNTHETIC WHITE

Used on portable and stationary tools to produce satin to mirror finishes, on surfaces such as brass, aluminum and stainless steel. Also utilized for removing scratches and surface imperfections.



Length	Width	Mineral	Item #	Pkg. Qty
18" (457 MM)	1/2" (13 mm)	Synthetic White	91512	1
		T Polishing	90052	1
	3/4" (19 mm)	Synthetic White	91513	1
		T Polishing	90053	1
	1" (25 mm)	Synthetic White	91500	1
	24" (610 MM)	1/2" (13 mm)	Synthetic White	91516
T Polishing			90054	1
1" (25 mm)		Synthetic White	91518	1

Length	Width	Mineral	Item #	Pkg. Qty
30" (762 MM)	1-1/2" (38 mm)	Synthetic White	91523	1
		T Polishing	90108	1
10-11/16" (272 MM)	3" (76 mm)	T Polishing	90048	1
		Synthetic White	91498	1
15-1/12" (384 MM)	3-1/2" (89 mm)	Synthetic White	91498	1

POLISHING BUFFING COMPOUNDS



PRODUCTS FOR USE ON STAINLESS STEEL

- 1 Begin with 78231 (Gray)
- 2 Followed by 78232 (White)
- 3 Finish with 78233 (Christmas Green)



PRODUCTS FOR USE ON ALUMINUM

- 1 Begin with 78234 (Brown)
- 2 Followed by 78235 (Mint Green)
- 3 Finish with 78233 (Christmas Green)



PRODUCTS FOR USE ON BRASS

- 1 Begin with 78234 (Brown)
- 2 Followed by 78235 (Mint Green)
- 3 Finish with 78236 (Red Rouge)

Product Color	Item #	Pkg. Qty
Gray	78231	1
White	78232	1
Christmas Green	78233	1
Brown	78234	1
Mint Green	78235	1
Red Rouge	78236	1
Blue	78237*	1

*For use on plastics only.

LOCKING-TYPE DISCS

For polishing stainless steel, aluminum and brass. Mirror finish can be achieved by pairing Dynabrade tools with polishing discs and compounds.



Diameter	Material	Item #	Pkg. Qty
2"	White	91496	10
	Wool	91497	10
3"	White	91502	10
	Wool	91503	10

HOOK-FACE BUFFING PADS POLISHING - HOOK-FACE

For use with Dynabrade Buffing Tools.



YELLOW FOAM

Cutting - foam cells are larger and further apart than White Foam cells making the action more aggressive.



WHITE FOAM

Polishing - foam cells are smaller and closer together than Yellow Foam cells making the action less aggressive.



ORANGE WAFFLE FOAM

Use during compounding stage to remove swirl and haze marks.



TERRY CLOTH

Application and removal of waxes and polishes.



SYNTHETIC WOOL

Final finishing and polishing.



NATURAL SHEEPSKIN

Final finishing and polishing; softer feel than synthetic wool.

	Material	Type	Color	Item #
3" (76 MM)	Terry Cloth	Polishing	White	90027
	Synthetic Wool	Polishing	White	90028
	Foam Flat	Polishing	White	90038
	Foam Flat	Cutting	Yellow	90044
	Natural Sheepskin	Polishing	White	90080
3-1/4" (83 MM)	Foam Waffle	Polishing	Orange	90070
3-1/2" (89 MM)	Natural Sheepskin	Polishing	Tan	90034
3-3/4" (95 MM)	Foam Waffle	Polishing	Orange	90071
4" (102 MM)	Cotton Buff	Polishing	White	90024

	Material	Type	Color	Item #
5" (127 MM)	Natural Sheepskin	Polishing	Tan	90036
	Foam Flat	Polishing	White	90040
	Foam Flat	Cutting	Yellow	90045
	Natural Sheepskin	Polishing	White	90081
5-1/4" (133 MM)	Foam Waffle	Polishing	Orange	90063
6" (152 MM)	Foam Flat	Polishing	Yellow	54330*
		Cutting	Yellow	90046
		Polishing	White	90047
7" (178 MM)	Natural Sheepskin	Polishing	White	90082
8" (203 MM)	Foam Flat	Polishing	Blue	90041
	Synthetic Wool	Cutting	White	90083

DYNABUFFER



3" DIAMETER BUFFER



DYNABUFFER



*Note: Item number 54330 has 5/16"-24 male thread.

BI-METAL RECIPROCATING SAW BLADES

Shatter-resistant Bi-Metal Saw Blades have greater durability and flexibility than single metal blades.

Blades with 6 teeth per inch: Used for demolition work in nail-embedded wood; also for fast cutting of composites.

Blades with 10 teeth per inch: Used for demolition work in nail-embedded wood; also on pipe, stainless steel, carbon steel up to 1/4" thick.







Blades with 18 teeth per inch: Used on pipe, stainless steel, carbon steel up to 3/16" thick.

	L x W	Blade Thickness	Shaft Width	Teeth Per Inch	Item #	Pkg. Qty
	6" x Taper	0.05"	1/2"	6	90934	1
	6" x 3/4"	0.035"		18	90937	1
	6" x 3/4"	0.035"		10	90939	1

RECIPROCATING FILES DOUBLE CUT SWISS PATTERN







For precision finishing on delicate parts and delicate substrates. Also used for deburring and detail work.

3-1/2" TO 4" IN LENGTH

Shape	Tang	File Type	Item #	Pkg. Qty
	ø 3 mm	Straight "00" Very Coarse	90900	1
		Curved "0" Coarse	90901	1
	ø 3 mm	Straight "00" Very Coarse	90910	1
		Curved "0" Coarse	90911	1
	ø 3 mm	Straight "00" Very Coarse	90920	1
		Curved "0" Coarse	90921	1
	ø 3 mm	Curved "0" Coarse	90931	1
	ø 3 mm	Straight "00" Very Coarse	90940	1
		Curved "0" Coarse	90941	1
	ø 3 mm	Straight "00" Very Coarse	90950	1
		Curved "0" Coarse	90951	1



6" IN LENGTH

Shape	Tang	Cut	Item #	Pkg. Qty
	ø 6 mm	Curved Double Cut "0" (Coarse)	90985	1
	11 mm x 2.5 mm	Straight Double Cut "00" (Very Coarse)	90981	1
		Curved Double Cut "0" (Coarse)	90986	1
	ø 6 mm	Straight Double Cut "00" (Very Coarse)	90982	1
	ø 6 mm	Straight Single Cut "00" (Very Coarse)	90979	1
	ø 6 mm	Straight Double Cut "00" (Very Coarse)	90983	1
		Curved Double Cut "0" (Coarse)	90988	1
	ø 6 mm	Straight Double Cut "00" (Very Coarse)	90984	1
		Curved Double Cut "0" (Coarse)	90989	1
	6 mm x 2.8 mm	Aluminum Type A Flat	90905	1



DIAMOND CUT-OFF WHEELS

Utilized for fiberglass mold and flash trimming, plus trimming of composite components.

Continuous Rim: Used most commonly for fiberglass cutting.

Continuous Rim with Side Spoke: Used for sawing thicker material and curved surfaces, without jamming the wheel and stalling the tool.

Gulleted/Slotted: Used for cutting fiberglass 3/4" thick or more.



Wheel Dia.	Center Hole	Thickness	Diamond Grit Wrap	Max. RPM	Wheel Type	Grit	Item #	Pkg. Qty
3"	3/8"	3/32"	1/8"	20,000	Continuous Rim	40/50	93917	1
					Side Spoked		93646	1
					Gulleted/Slotted		93658	1
4-1/2"	3/8"	3/32"	1/8"	20,000	Gulleted/Slotted	40/50	94912	1
5"	3/4"	3/32"	1/8"	15,000	Continuous Rim	40/50	93921	1
					Side Spoked		93650	1
					Gulleted/Slotted		93662	1

DIAMOND MOUNTED CUT-OFF WHEELS

Utilized for fiberglass mold and flash trimming, plus trimming of composite components.



Dia.	Mandrel Width	Mandrel Length	Thickness	Diamond Grit Wrap	Max. RPM	Wheel Type	Grit	Item #	Pkg. Qty
3"	3/8"	2-1/4"	3/32"	1/8"	20,000	Continuous Rim	40/50	93906	1
						Side Spoked		93907	1

DYNASCALER FLAPS AND HUB

For use with Dynabrade Dynascaler Surface Preparation Tool. Excellent for flat areas and large vertical surfaces, including beams, girders, and tank shells; near walls or within confined surfaces. Also for removing paint, corrosion, oxide and mill scale.

DYNAPEEN FLAPS - TYPE C

Flap Size	Item #	Pkg. Qty
1"	39000	6
2"	39200	6



DYNAPEEN HUB

Flap Size	Item #	Pkg. Qty
2-1/4"	30330	1



SCRIBE POINTS & CHISELS

For use with Dynabrade DynaPen Tool. Scribe points are made of high-carbon steel, and are ideal for engraving metal, wood, stone, glass and composites. Chisels are effective for removing parting lines on metal and plastic. Utilized by dental mold-makers, jewelers, artists and in archeology shops.

Description	Shaft Dia.	Tip Width	Item #	Pkg. Qty
Scribe Point	1/8"	-	90990	1
	3 mm	-	90991	1
Narrow Chisel	3 mm	3 mm	90993	1
Wide Chisel	1/8"	1/8"	90994	1
	3 mm	3 mm	90995	1



COATED ABRASIVE BASICS ABRASIVE TYPES

1

CERAMIC ALUMINA C/A

Ceramic Alumina is the most recent abrasive technology introduced in its first forms in the early 1980's. Chemical variations and special forming techniques continue to advance the use of this abrasive technology into more and more applications and material types.

2

The sub-micron structure of ceramic alumina allows each grain to continually expose sharp cutting points, resulting in a cooler cutting action and an extended life. It is the first choice for use on ferrous/non-ferrous metals, carbon steel and exotic alloys.

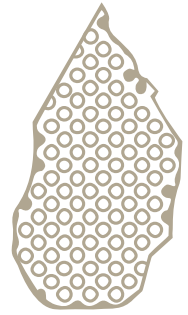

3

ZIRCONIA ALUMINA Z/A

Zirconia alumina is a super tough, man-made abrasive first introduced in the mid 1970's. It is tougher and sharper than aluminum oxide and retains its sharpness for a longer period. The microcrystalline structure ensures a more controlled breakdown, becoming self sharpening resulting in a free, cool cut for high stock removal applications.

Ideal for heavy-duty grinding of all ferrous and non-ferrous metals, high stock removal on wood, plywood and particleboard, grinding fiberglass, rubber and plastics.



4

ALUMINUM OXIDE A/O

Aluminum Oxide was the second man-made abrasive to be invented. It is made in several versions including but not limited to Brown Aluminum Oxide, Light Brown Aluminum Oxide, White Aluminum Oxide and others.

Aluminum oxides run the gamut from very tough, block shaped and durable to hard, friable and very sharp. The result is an abrasive that can penetrate hard materials at high speeds for rapid stock removal. Aluminum oxides resist wear, generate a cool cutting action, provide long life and a freeness of cut on the widest range of materials.

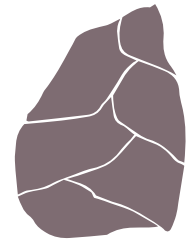

5

SILICON CARBIDE S/C

Silicon carbide was the first man-made abrasive. It is the hardest and sharpest of the manufactured abrasives.

Blue/black in color, this abrasive grain enables fast stock removal and a cool cutting action on cast iron, non-ferrous metals, glass, rubber, plastic and stone. It is often used for final finishing on wood and creates the blue-bright finish on stainless steel.



COATED ABRASIVE BASICS

BOND TYPES

An adhesive bond or bond system is required to secure the abrasive grain to a backing. The majority of coated abrasive products are made with a two-stage bonding process while some unique polishing and lapping products being coated in one stage.

The make-coat and the size-coat are the two stages in most bonding processes. The make-coat is the initial layer of adhesive applied to the backing and allows for the precise placement of the abrasive grain onto the backing. This initial coating of make coat and grain is then dried to hold the grain in place. The size-coat is then applied over the abrasive mineral and make-coat and anchors the abrasive grain in place providing the desired physical strength of the finished product.

Adhesives include glue, urea resin, and phenolic resin are the three basic bonding agents most commonly used. There are numerous bond systems resulting from combinations of size-coat and make-coat adhesive like glue over glue, urea over glue, resin over glue and resin over resin. Glue over glue is the most flexible and oldest of the bond systems, while resin over resin bond is moisture-resistant, harder, less flexible, heat-resistant and has superior grain retention.

COATING TYPES

There are two common types of abrasive coatings most often used in the manufacturing of coated abrasives:
OPEN COAT AND CLOSED COAT.

- 1 OPEN COAT** → Coated abrasives made in an “open coat” have approximately 50% to 75% of the surface covered by abrasive grain. The evenly spaced voids between the particles of grain provide for chip clearance and reduces the effect of loading caused by wood dust or metal particles.
- 2 CLOSED COAT** → Coated abrasives made with a “closed” coating have virtually the entire surface of the backing covered with abrasive grain, with no voids between the particles. This is the most common coating, resulting in the most cutting tools available to produce the highest degree of stock removal and longest product life.

COATED ABRASIVES STORAGE & HANDLING

When coated abrasives are stored under proper conditions they will retain their useful life and performance over a longer period of time. When stored inadequately coated abrasives can become brittle, curl excessively, the adhesive bonds can weaken and breakage can occur. Storage temperature and humidity are two of the most important factors affecting coated abrasive performance. Some backings and bonds are sensitive to heat and humidity and will gain or lose moisture quickly as the surrounding conditions change. Some adhesive bonds weaken when exposed to high humidity causing the coated abrasive surface to fill or clog more quickly and cut less aggressively reducing productivity. When exposed to low moisture conditions for extended periods of time, certain coated abrasives can become brittle, less flexible and distort from their original shapes. This is especially true with paper and fiber backed abrasives where increasing or decreasing moisture in the backing can cause dimensional changes. When moisture increases or decreases in the backing it usually occurs at a rate faster than the coating it causes cupping or curling. Film backed coated abrasives and synthetic cloth back coated abrasives are less susceptible to the effects of changes in humidity, however cold temperatures can create a condition where the product should be allowed to come up to ambient room temperatures before use.

Ideally coated abrasives should be stored in a separate room whose partitions do not include outside walls. Humidity should be maintained around 50% with a temperature between 60 and 80 degrees. Keep all coated abrasives in their original containers as they are received. Cartons and boxes should be kept off floors and away from cold walls where they could absorb moisture. They should be kept away from direct sources of heat or cold – radiators, steam pipes, heat and air conditioning ducts or rooms near other sources of heat like ovens or furnaces.

COATED ABRASIVE BASICS BACKING TYPES



PAPER

The smooth surface of paper results in products that can generate a consistent finish. Paper backings range in weights and corresponding thicknesses from A-weight to F-weight with A being the thinnest and most flexible to F as the thickest most durable.

A, B, C and D weight - commonly used for hand sanding and light to moderate machine sanding in the form of sheets, PSA (pressure sensitive adhesive) and Hook and Loop discs and sheet rolls.

E and F weight - for more aggressive mechanical operations and are used most commonly in the form of belts and discs.

CLOTH

Cloth backings are also identified by weight with the three most common being:

J-weight - most flexible

X-weight - a common heavy cloth that varies the most in flexibility, strength, and durability

Y-weight - heavyweight cloth expressly used for high stock removal operations.

Common cloth types used in coated abrasives are cotton, polyester, polyester, nylon, polyester/cotton blends, and rayon. Before it is coated with adhesives and abrasive grain, cloth backings first need to be filled or finished. A variety of fill or finishing materials are used to fill the voids and gaps in a woven cloth backing and can include glues, resins, or combinations of both to create various characteristics like flexibility, and toughness.

FIBER

Vulcanized fiber (a process where cotton fibers are chemically treated and then pressed under temperature and pressure to form a very durable backing) is used as the backing for resin fiber discs.

POLYESTER

Polyester film backings come in several thicknesses with 3 mil. and 5 mil. being the most commonly used for coated abrasives. Polyester films have high strength and are the smoothest of surfaces ensuring even coating. Film backed coated abrasives are most commonly used in disc shapes and rolls for applications requiring precise and consistent surface finish.

TESTING ABRASIVES

MEASURING MATERIAL REMOVAL

MEASURING Material Removal by Weight/Rate of Removal

1 SET TEST PARAMETERS.

- ↳ Choose two identical work pieces.
- ↳ Establish grind time.
- ↳ Label each work piece.
- ↳ Choose one machine and one operator (for consistency).



2 WEIGH EACH WORK PIECE PRIOR TO GRINDING.

3 GRIND WORK PIECE "ONE" WITH CURRENT SUPPLIER'S ABRASIVES FOR PREDETERMINED GRIND TIME.

4 GRIND WORK PIECE "TWO" WITH NEW ABRASIVE FOR THE SAME PREDETERMINED GRIND TIME.

5 WEIGH EACH WORK PIECE AND COMPARE REMOVAL AND FINISH.

MEASURING CYCLE TIMES

MEASURING Cycle Times

1 SET TEST PARAMETERS.

- ↳ Collect two groups of identical work pieces.
- ↳ Establish the number of work pieces to be completed.
- ↳ Label each group.
- ↳ Choose one machine and one operator (for consistency).
- ↳ Have a timing device available.



2 GRIND GROUP "ONE" WITH CURRENT SUPPLIER'S ABRASIVE.

- ↳ Record the time it takes to process the predetermined number of work pieces.

3 GRIND GROUP "TWO" WITH THE NEW TEST ABRASIVE.

- ↳ Record the time it takes to process the predetermined number of work pieces.

4 COMPARE THE TIME IT TAKES TO COMPLETE EACH GROUP ALONG WITH THE FINISH OF THE WORK PIECES.

TESTING ABRASIVES CONTINUED

MEASURING Cost per Part/# of Pieces

MEASURING COST PER PART

1 SET TEST PARAMETERS

- ↳ Collect two groups of identical work pieces.
- ↳ Label each group.
- ↳ Choose one machine and one operator (for consistency).



2 INSTALL A NEW BELT FROM THE CURRENT SUPPLIER

- ↳ Record the number of parts completed with the abrasive from the current supplier.
- ↳ Take the price of the current supplier's abrasive and divide by the number of work pieces completed. This will show you the current suppliers abrasive cost per piece.

3 INSTALL A NEW TEST ABRASIVE

- ↳ Record the number of parts completed with the test abrasive.
- ↳ Take the price of the test abrasive and divide by the number of work pieces completed by that abrasive. This will show you the suppliers abrasive cost per piece.

4 COMPARE THE COST PER WORK PIECE FOR EACH ABRASIVE ALONG WITH THE FINISH

- ↳ *Example: Cost of Abrasive = Cost per Piece Divided by Number of Pieces Completed* Number of Pieces Completed

DYNABRADE COST SAVINGS PROGRAM

SAVE COSTS & OPTIMIZE TIME



Dynabrade provides the service of documenting cost savings to improve our customer's profitability and strengthen our relationship with our business partners. An avenue to solidify that relationship is to reduce the amount of time it takes to achieve the desired outcome from their operations. Even saving just a few minutes per part can equate to a significant cost savings throughout the year.

- *Substantial cost savings can be achieved by using high-quality, American made Dynabrade products and by focusing on reducing cycle times for labor intensive operations.*

GRIT GRADING SYSTEMS

ANSI or CAMI	FEPA (P-Grade)	Micro-Mesh Aluminum Oxide	Micro-Mesh Regular	Micro-Mesh MX	Micron	DynaBrite® Surface Conditioning
•	•	1200 A/O	12000	•	•	•
•	•	8000 A/O	8000	1200 MX	•	•
•	•	6000 A/O	6000	800 MX	•	•
1500	•	4000 A/O	4000	600 MX	•	•
1350	•	3600 A/O	3600	•	•	•
1200	•	3200 A/O	3200	•	•	•
•	P2500	•	•	400 MX	6	•
1000	•	•	•	•	•	Ultra Fine
•	P2000	•	•	360 MX	10	•
•	•	2400 A/O	2400	320 MX	•	•
800	P1500	•	•	•	12	•
600	•	1800 A/O	1800	•	15	Super Fine
•	P1200	•	•	•	•	•
500	P1000	•	•	•	•	•
•	P800	•	•	240 MX	22	•
400	•	1500 A/O	1500	•	30	•
•	P600	•	•	•	•	•
360	•	800 A/O	•	•	•	•
•	P500	•	•	•	•	•
•	P400	•	•	•	35	•
320	•	600 A/O	•	180 MX	•	Very Fine
280	P360	•	•	150 MX	40	•
240	•	•	•	•	50	Fine
•	P320	•	•	120 MX	52	•
•	P280	•	•	100 MX	•	•
•	•	•	•	80 MX	•	•
•	P240	•	•	60 MX	•	•
220	P220	•	•	•	60	•
180	P180	300 A/O	•	•	80	•
150	•	•	•	•	100	Medium
•	P150	•	•	•	110	•
120	•	•	•	•	120	Coarse
•	P120	•	•	•	125	•
100	•	•	•	•	150	Extra Coarse
•	P100	•	•	•	•	•
80	•	•	•	•	180	•
•	P80	•	•	•	•	•
•	P60	•	•	•	•	•
60	•	•	•	•	•	•
•	P50	•	•	•	•	•
50	•	•	•	•	•	•
•	P40	•	•	•	•	•
40	•	•	•	•	•	•
•	P36	•	•	•	•	•
36	•	•	•	•	•	•
•	P30	•	•	•	•	•
30	•	•	•	•	•	•
24	•	•	•	•	•	•
•	P24	•	•	•	•	•

COMMON TERMS & DEFINITIONS

Trademarks and Tradenames

DynaCut™, DynaBrite®, DynaStrip™, DynaBlend™, DynaPrep™, DynaFinish™, DynaFire™, DynaBurr™, DynaPeen

Common Terms and Definitions



Aluminum Oxide AO	Extremely tough blocky wedge shaped abrasive mineral best used for high speed penetration of tough materials without fracturing when grinding such as carbon steel, alloy steels, tough bronze and hardwoods.
Alumina Zirconia AZ	An alloyed version of aluminum oxide that fuses Zirconia with aluminum oxide to form a unique self-sharpening crystalline structure that is approximately 10% harder than aluminum oxide providing long life on rugged stock removal operations.
Bonded Abrasives	A general term used to describe grinding wheels and cutting wheels produced by compressing a blend of abrasive grains, an adhesive binder and various grinding aids and reinforcing fabric under heat and pressure.
Buffing	Smoothing a surface by the use of rotary or orbital discs, pads or wheels.
Coated Abrasive	Any abrasive product where a cloth, paper, film, fiber or mesh substrate is coated with layer or layers of adhesive and abrasive.
Ceramic Alumina CA	A unique combination of alumina and chemicals to form a ceramic paste that results in a hard, tough and dense abrasive that has exceptionally high purity. It features a sharp microcrystalline that provides outstanding results on a broad range of carbon steels, aerospace alloys, high nickel alloys and stainless steels as well as hardwoods and MDF.
Convolute Wheel	An abrasive that is formed by winding a resin and abrasives saturated non-woven web around a core to form a wheel. Convolute wheel can run in only one direction and are marked by a directional arrow.
Deburring	The process to remove metal burrs that result from previous cutting or boring operations.
De-nibbing	The process of removing small raised surface imperfections or “nibs” from a painted or coated surface.
Friable	The characteristic of an abrasive grain to break down and provide sharp new cutting surfaces.
Hook and Loop	An attachment system for sheets or discs to adhere to a back-up pad. Hook and loop abrasives can be removed from the back-up pad and if not worn out re-used again when needed.
Lapping	A polishing process using coated abrasives to generate a highly polished surface.
Micro Finishing	A finishing process using coated abrasives to produce a measurable and specific microfine scratch pattern on a surface.
Non-Woven Abrasives	A flexible conformable abrasive made by combining an open structure non-woven web of interlocking fibers with adhesive and abrasive.

COMMON TERMS & DEFINITIONS CONTINUED

Peening	A steel shot blasting treatment applied to a metal surface to improve metallurgical properties.
PSA	Pressure sensitive adhesive coating for attaching discs or sheets to back-up pads.
Ra	Arithmetic mean value of surface roughness.
Rmax	Maximum peak to valley height.
Rz	Mean peak to valley height.
Silicon Carbide (Sic)	The hardest abrasive other than diamonds. It is a friable synthetic abrasive ideal for finishing non-ferrous metals (aluminum, magnesium, brass, bronze, titanium, etc), rubber, glass, plastics, coatings. It is also used for producing specific finishes on stainless steel.
Unitized Wheels/Discs	Non-Woven abrasives made by compressing layers of resin and grain saturated non-woven web under heat and pressure to a specific thickness.
Vitrified Bond	A glass like bond system for bonded abrasive products like mounted points and wheels.
Zirconia Alumina	See Alumina Zirconia.

WE LISTEN. WE OBSERVE. **WE OPTIMIZE.**



Dynabrade, Inc.
8989 Sheridan Drive
Clarence, New York 14031-1419

USA Customers 1-800-828-7333
Canada Customers 1-800-344-1488
dynabrade.com

Distributed By: